



HF/VHF/UHF

ULTRA-COMPACT TRANSCEIVER

FT-857/-857D

Technical Supplement

©2007 VERTEX STANDARD CO., LTD. EH007M90C

VERTEX STANDARD CO., LTD.
4-8-8 Nakameguro, Meguro-Ku, Tokyo 153-8644, Japan

**VERTEX STANDARD
US Headquarters**
10900 Walker Street, Cypress, CA 90630, U.S.A.

YAESU EUROPE B.V.
P.O. Box 75525, 1118 ZN Schiphol, The Netherlands

YAESU UK LTD.
Unit 12, Sun Valley Business Park, Winnall Close
Winchester, Hampshire, SO23 0LB, U.K.

VERTEX STANDARD HK LTD.
Unit 5, 20/F., Seaview Centre, 139-141 Hoi Bun Road,
Kwun Tong, Kowloon, Hong Kong

VERTEX STANDARD (AUSTRALIA) PTY., LTD.
Normanby Business Park, Unit 14/45 Normanby Road
Notting Hill 3168, Victoria, Australia

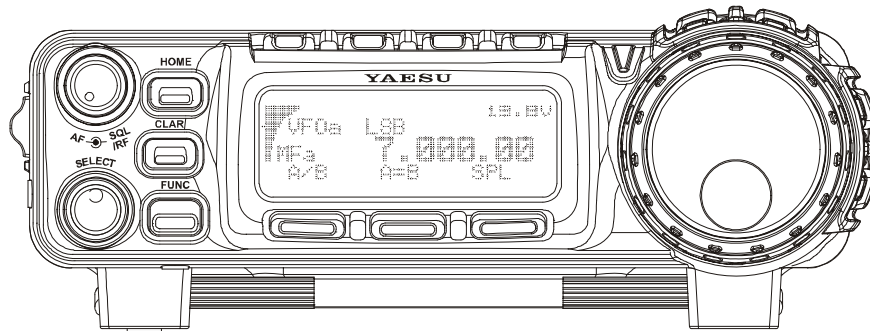

Introduction

This manual provides technical information necessary for servicing the FT-857/-857D HF/VHF/UHF Ultra-Compact Transceiver.

Servicing this equipment requires expertise in handling surface-mount chip components. Attempts by non-qualified persons to service this equipment may result in permanent damage not covered by the warranty, and may be illegal in some countries.

Two PCB layout diagrams are provided for each double-sided circuit board in the Transceiver. Each side of is referred to by the type of the majority of components installed on that side (“leaded” or “chip-only”). In most cases one side has only chip components, and the other has either a mixture of both chip and leaded components (trimmers, coils, electrolytic capacitors, ICs, etc.), or leaded components only.

While we believe the technical information in this manual to be correct, VERTEX STANDARD assumes no liability for damage that may occur as a result of typographical or other errors that may be present. Your cooperation in pointing out any inconsistencies in the technical information would be appreciated.

Contents

| | | | |
|------------------------------------------------------|-----------|-----------------------------------------------------|-----|
| Specifications | 2 | Board Unit (Schematics, Layouts & Parts) | |
| Exploded View & Miscellaneous Parts | 5 | MAIN Unit | 25 |
| Connection Diagram | 7 | PLL Unit | 63 |
| Block Diagram | 8 | PA Unit | 75 |
| Circuit Description | 9 | PANEL Unit | 93 |
| Alignment | 12 | REF Unit | 99 |
| | | PHONE-JACK Unit | 100 |
| | | VR Unit | 101 |
| | | CONNECTOR Unit | 102 |
| | | DSP-2 Unit (FT-857 Option) | 103 |
| | | TCXO-9 Unit (Option) | 106 |

Specifications

General

| | |
|----------------------------------|--------------------------------------------------------------------------------------------------------------------------------------|
| Frequency Range: | Receive: 0.1-56 MHz, 76-108 MHz, 118-164 MHz, 420-470 MHz Transmit: 160 - 6 Meters, 2 Meters, 70 Centimeters (Amateur bands only) |
| Emission Modes: | A1 (CW), A3 (AM), A3J (LSB/USB), F3 (FM), F1 (9600 bps packet), F2 (1200 bps packet) |
| Synthesizer Steps (Min.): | 10 Hz (CW/SSB), 100 Hz (AM/FM/WFM) |
| Antenna Impedance: | 50 Ohms, Unbalanced |
| Operating Temp. Range: | 14 °F to 140 °F (-10 °C to +60 °C) |
| Frequency Stability: | ±4 ppm from 1 min. to 60 min after power on. @25 °C: 1 ppm/hour ±0.5 ppm/1 hour @25 °C, after warmup (with optional TCXO-9) |
| Supply Voltage: | Normal: 13.8 VDC ±15 %, Negative Ground |
| Current Consumption: | Squelched: 550 mA (Approx.) Receive: 1 A Transmit: 22 A |
| Case Size (W x H x D): | 6.1" x 2.0" x 9.2" (155 x 52 x 233 mm) |
| Weight (Approx.): | 4.6 lb. (2.1 kg) |

Transmitter

| | | | |
|-----------------------------------------|------------------------------------------------------------------------------------|-----------|------------|
| RF Power Output: (@13.8 V DC) | | SSB/CW/FM | AM Carrier |
| | 160- 6 M: | 100 W | 25 W |
| | 2 M: | 50 W | 12.5 W |
| | 70 CM: | 20 W | 5 W |
| Modulation Types: | SSB: Balanced Modulator, AM: Early Stage (Low Level), FM: Variable Reactance | | |
| FM Maximum Deviation: | ±5 kHz (FM-N: ±2.5 kHz) | | |
| Spurious Radiation: | -50 dB (1.8-29.7 MHz) -60 dB (50/144/430 MHz) | | |
| Carrier Suppression: | >40 dB | | |
| Opp. Sideband Suppression: | >50 dB | | |
| SSB Frequency Response: | 400 Hz-2600 Hz (-6 dB) | | |
| Microphone Impedance: | 200-10k Ohms (Nominal: 600 Ohms) | | |

Specifications

Receiver

| | | | | |
|----------------------------------|---------------------------------------------------------------------------------------------------------------------------------------------------------------------------------------------------------------------------------------------------------|---------------|--------------|-------------|
| Circuit Type: | Double-Conversion Superheterodyne (SSB/CW/AM/FM) Superheterodyne (WFM) | | | |
| Intermediate Frequencies: | 1st: 68.33 MHz (SSB/CW/AM/FM); 10.7 MHz (WFM) 2nd: 455 kHz | | | |
| Sensitivity: | | SSB/CW | AM | FM |
| | 100 kHz-1.8 MHz | – | 32 μ V | – |
| | 1.8 MHz-28 MHz | 0.2 μ V | 2 μ V | – |
| | 28 MHz-30 MHz | 0.2 μ V | 2 μ V | 0.5 μ V |
| | 50 MHz-54 MHz | 0.125 μ V | 1 μ V | 0.2 μ V |
| | 144/430 MHz | 0.125 μ V | – | 0.2 μ V |
| | (SSB/CW/AM = 10 dB S/N, FM = 12 dB SINAD) | | | |
| Squelch Sensitivity: | | SSB/CW/AM | FM | |
| | 100 kHz-1.8 MHz | – | – | |
| | 1.8 MHz-28 MHz | 2.5 μ V | – | |
| | 28 MHz-30 MHz | 2.5 μ V | 0.32 μ V | |
| | 50 MHz-54 MHz | 1 μ V | 0.16 μ V | |
| | 144/430 MHz | 0.5 μ V | 0.16 μ V | |
| Image Rejection: | HF/50 MHz: 70 dB, 144/430 MHz: 60 dB | | | |
| IF Rejection: | 60 dB | | | |
| Selectivity (–6/–60 dB): | SSB/CW: 2.2 kHz/4.5 kHz AM: 6 kHz/20 kHz FM: 15 kHz/30 kHz FM-N: 9 kHz/25 kHz SSB (optional YF-122S installed): 2.3 kHz/4.7 kHz (–66 dB) CW (option YF-122C installed): 500 Hz/2.0 kHz CW (option YF-122CN installed): 300 Hz/1.0 kHz | | | |
| AF Output: | 2.5 W (@4 Ohms, 10% THD or less) | | | |
| AF Output Impedance: | 4-16 Ohms | | | |

Specifications are subject to change without notice, and are guaranteed within the amateur bands only.

Note

Note

Connection Diagram

CONNECTION-DIAGRAM (BPO 109900)

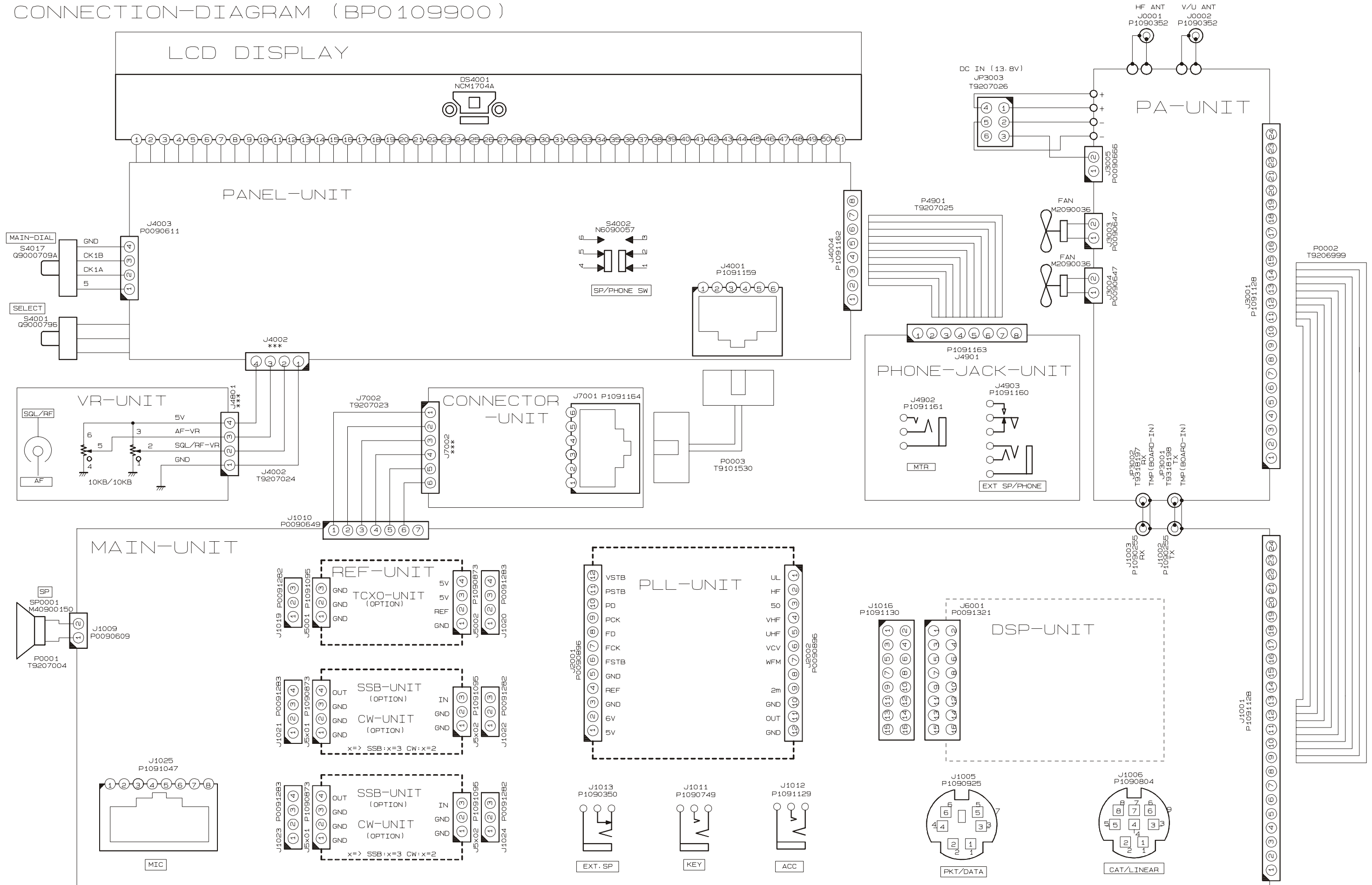

Block Diagram

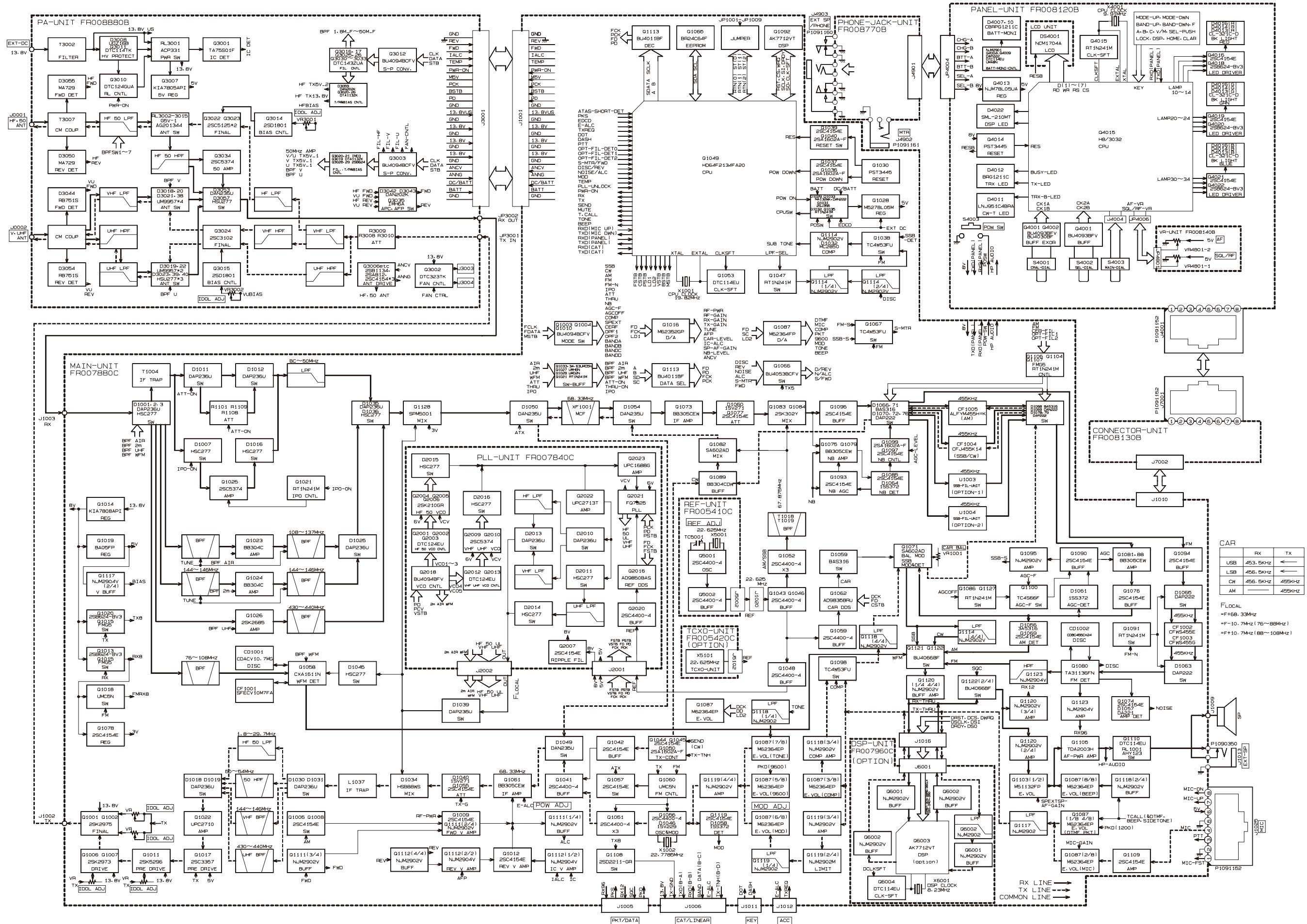

Receive Signal Circuitry

RF Stages

Signals between 0.1 and 56 MHz received at the antenna terminal pass through a low-pass filter, selected according to the receiving frequency, then pass to another low-pass filter, to remove unwanted out-of-band signals. The filtered receiving signal passes, through one of the following circuits, to the 1st Mixer **Q1128** (SPM5001): (1) an attenuator network (−10dB) which consists of resistors R1101, R1108, R1109; (2) a “through” circuit enabled via diodes **D1011** and **D1012** (both **DAP236U**); or (3) RF amplifier **Q1025** (**2SC5374**).

Received 430 MHz signals, after passing through a high-pass filter composed of L3058, L3069, C3250, C3251, C3253, C3258, and C3298, are passed through low-pass filter composed of L3043, L3044, C3209, C3211, C3214, C3215, C3246, and C3255, and through a directional coupler, to the UHF T/R switch circuit composed of diode switch **D3019/D3022** (both **UM9957F**), **D3023**, and **D3039** (both **HSU277**). Then the signals are fed to the 1st Mixer **Q1128** via the RF-AMP **Q1026** (**2SK2685**).

Received 145 MHz signals, after passing through a high-pass filter composed of L3055, L3056, L3067, C3248, C3249, C3252, and C3254, are passed through a low-pass filter composed of L3040, L3041, C3204, C3205, C3210, C3213, and C3216, and a directional coupler, to the VHF T/R switch circuit, composed of diode switch **D3018/D3021** (both **UM9957F**). Then the signals are fed to 1st Mixer **Q1128** via the RF-AMP, **Q1024** (**BB304CDW**).

Received 76-108 MHz signals, after passing through a high-pass filter composed of L3055, L3056, L3067, C3248, C3249, C3252, and C3254, are passed through low-pass filter composed of L3040, L3041, C3204, C3205, C3210, C3213, and C3216, and a directional coupler, to the T/R switch circuit, composed of diode switch **D3018/D3021** (both **UM9957F**). Then it is fed to the Wide-FM IF IC **Q1058** (**CXA1611N**) on the MAIN Unit.

1st Mixer Circuit/1st IF Circuit

The 1st mixer on the MAIN Unit consists of quad MOS FET **Q1128** (**SPN5001**), where the receiving signal is mixed with the 1st local signal (68.430-538.330 MHz) from the PLL Unit. The resulting output signal (68.33 MHz) passes through monolithic crystal filter (MCF) **XF1001** (**MF68Q**, BW: ±6.0 kHz) to obtain the 1st IF signal with a center frequency of 68.33 MHz. The IF signal passes through the 1st IF amplifier **Q1073** (**BB305CEW**) to the 2nd Mixer, **Q1083** and **Q1084** (both **2SK302Y**).

2nd Mixer Circuit/2nd IF Circuit

The 2nd Mixer consists of FETs **Q1083** and **Q1084** (both **2SK302Y**) on the MAIN Unit, where the 1st IF signal is mixed with the 2nd local signal (67.875 MHz). The resulting output signal (455 kHz) is applied to the 2nd IF

filter which is matched to the receiving mode: either CF1004, CF1005 or an optional mechanical filter.

Noise Blanker Circuit

A portion of the 2nd IF signal is amplified by Noise Blanker Amplifiers **Q1075** and **Q1079** (both **BB305CEW**) on the MAIN Unit, and then rectified by **D1064** (**1SS372**). This output is applied to the Noise Blanker Controllers, **Q1093** (**2SC4154E**) and **Q1099** (**2SA1602A**), which yield Blanking signal according to the timing of the incoming noise pulses. Then Blanking signal controls the Noise Blanker Gate **D1066** (**BAS316**), to slice out the impulse noise from the signal.

AGC Circuit

The AGC circuit consists of **D1061** (**1SS372**), transistor **Q1090** (**2SC4154E**), and associated parts on the MAIN Unit. Output from the AGC circuit is fed back to the IF AGC circuit that controls the gain of the IF amplifier FETs.

FM IF Circuit/FM Demodulator Circuit

On FM, the 2nd IF signal passes through the buffer amplifier **Q1094** (**2SC4154E**) and 2nd IF filters (**CF1002** and **CF1003**) to the FM IF IC **Q1080** (**TA31135FN**) which contains a mixer, limiter amplifier, filter amplifier, squelch trigger, and demodulator. The demodulated audio signal at **Q1080** passes through a low-pass filter (R1339 and C1282) and a de-emphasis circuit (R1303 and C1345), then proceeds to the Audio Amplifier Circuit.

The squelch circuit selectively amplifies the noise component of the demodulator output using the filter amplifier inside the FM IF IC and an active band-pass filter consisting of an externally attached resistor and capacitor. Signal detection is performed by **D1057** (**DA221**).

SSB/CW Demodulator Circuit

The 2nd IF SSB/CW signal passes through buffer amplifiers **Q1088** and **Q1081** (both **BB305CEW**) to the SSB balanced demodulator **Q1071** (**SA602AD**) which produces audio by applying the carrier signal from the CAR-DDS IC **Q1062** (**AD9835BRU**). The demodulated audio signal is stripped of high-frequency components by an active low-pass filter, op-amp IC **Q1120** (**NJM2902V**), then is applied to the Audio Amplifier Circuit.

AM Demodulator Circuit

The 2nd IF AM signal passes through buffer amplifiers **Q1088** and **Q1081** (both **BB305CEW**) to the AM demodulator **D1055** (**BAS316**), yielding demodulated audio signal which is applied to the Audio Amplifier Circuit.

Audio Amplifier Circuit

The demodulated audio signal is passed through AF pre-amplifier **Q1119** (**NJM2902V**) and electronic volume control IC **Q1087** (**M62364EP**) to the AF Amplifier IC **Q1105** (**TDA2003H**) which drives the internal or external speaker to a maximum output of approximately 2.5 Watts.

Circuit Description

Transmit Signal Circuitry

Microphone Amplifier Circuit

The audio signal from microphone jack is amplified by audio amplifier **Q1109 (2SC4154E)** on the MAIN Unit, and then is applied to electronic volume control IC **Q1087 (M62364EP)**, the level of which is set via the User Menu.

SSB Modulator Circuit

The output (audio signal) from the electronic volume control IC is passed through audio amplifier **Q1118 (NJM2902V)** to the balanced modulator IC **Q1071 (SA602AD)** which produces a Double Sideband (DSB) signal by applying the carrier signal from the CAR-DDS IC **Q1062 (AD9835BRU)**. The DSB modulated signal (455 kHz) is fed to ceramic filter **CF1004** (or the optional mechanical filter) which strips residual carrier and the undesired sideband, resulting in a Single Sideband (SSB) signal.

AM Modulator Circuit

As in the SSB modulator circuit, a carrier signal appropriate to the transmitting mode (AM) from the CAR-DDS Unit and an audio signal from the microphone are applied to balanced modulator IC **Q1071 (SA602AD)**. The control signal from Mode Switch IC **Q1003 (BU4094BCFV)** causes a voltage (“AM 5V”) to be sent from transistor **Q1058 (2SC4154E)**. This voltage is applied to IC **Q1071** via **D1059 (BAS316)**, causing the balanced modulator to lose balance. The restored carrier signal and modulated signal are then fed to the TX mixer via ceramic filter **CF1004**.

FM Modulator Circuit

The output (audio signal) from the electronic volume control IC is passed through the pre-emphasis circuit which consists capacitor C1492 and resistors R1493 and R1477, and Instantaneous Deviation Control **Q1119 (NJM2902V)**, to the splatter filter which consists **Q1119**, capacitor C1430, and resistors R1358 and R1384. The filtered audio signal is applied to the FM modulator circuit, which produces the FM signal. The FM modulator circuit uses a voltage controlled crystal oscillator (VCXO) which consists **Q1055 (2SC4400)**, **D1046 (1SV229)**, and **X1002 (22.7767 MHz)**.

1st IF Circuit/1st Mixer Circuit

The modulated SSB/AM signal is applied to the 2nd Mixer **Q1082 (SA602AD)**, which produces the 68.33 MHz 2nd IF signal utilizing the 2nd local signal (68.875 MHz). The 2nd IF signal is fed through the 2nd IF filter **XF1004** which strips away unwanted mixer products, then passes through the 2nd IF amplifier **Q1061 (BB304CDW)** to the double balanced mixer **D1034 (HSB88WS)** which produces the transmit frequency by applying the local signal (68.430-538.330 MHz) from the PLL Unit. The transmit signal is passed through a low-pass filter (1.8-29.7 MHz), a high-pass filter (50-54 MHz), a band-pass filter (144-146 MHz), or a band-pass filter (430-450 MHz) which consists of various inductors and capacitors. The filtered transmit signal is amplified by **Q1017 (2SC3357)**, **Q1011 (2SK2596)**, **Q1006/Q1007 (2SK2973)**, and **Q1001/Q1002 (2SK2975)**, and is applied to the Power Amplifier: **Q3022/Q3023 (2SC5125: HF/50 MHz)** or **Q3024 (2SC3102: 144/430 MHz)**.

ALC Circuit

The output from the directional coupler is routed from connector J3001 and applied to the ALC circuit via connector J1001 on the MAIN Unit.

The ALC circuit consists of an op-amp circuit for amplifying the forward and reflected voltage, a time-constant ALC amplifier, and a transmit signal control circuit on the MAIN Unit. The forward voltage from connector J1001 on the MAIN Unit is added with a DC control voltage and is then applied to op-amp IC **Q1111 (NJM2902V)**. The reflected voltage is added with a DC control voltage and is then applied to op-amp IC **Q1112 (NJM2904V)**. In the event of high SWR conditions (SWR 3:1 or more), transmitter output is reduced, thus protecting the PA Unit from potential damage; a “HI SWR” indication also appears on the LCD, alerting the user to an antenna problem.

The ALC amplifier magnifies the forward wave output via transistor **Q1009 (2SC4154)**. This output then passes through a fast-attack, slow-delay RC time-constant circuit, which consists of R1051 and C1051, for input to the TX signal control circuit on the MAIN Unit. The TX control circuit adjusts the IF amplifier gain via gate 2 of FET **Q1061 (BB304CDW)** of the 2nd IF amplifier circuit, to prevent the TX output from exceeding the preset level.

PLL Frequency Synthesizer

The PLL Frequency Synthesizer consists mainly of the master reference oscillator circuit, 2nd local oscillator circuit, PLL IC, and CAR-DDS and REF-DDS units, which digitally synthesize carrier outputs, plus a PLL circuit which contains a voltage controlled oscillator (VCO).

Master Reference Oscillator Circuit

The master reference oscillator uses a Crystal Oscillator (oscillation frequency: 22.625 MHz) composed of **Q5001 (2SC4400-4)**, **X5001**, TC5001, C5001, and R5005. The reference oscillator signal passes through a buffer amplifier **Q5002 (2SC4400-4)**, and is then fed to the MAIN Unit via J5002.

CAR-DDS Circuit REF-DDS Circuit

DDS ICs **Q1062 (AD9835BRU)**, and **Q2016 (AD9850BAS)** each contain a shift register, selector, phase accumulator, and ROM. The reference oscillation frequency (22.625 MHz) that is delivered to each of the DDS Units is applied to each DDS IC after amplification by transistors **Q1043**, **Q1046**, **Q1048**, and **Q1059** (all **2SC4400-3**).

The DDS outputs contain digital amplitude data corresponding to serial frequency data from CPU IC **Q1049**. The DDS frequency range is 453.5 ~ 466.5 kHz (center frequency = 455.0 kHz) for the CAR-DDS, and 7.2-8.0 MHz for the REF DDS.

1st Local Oscillator Circuit

VCO output is buffer-amplified by **Q2011 (2SC5374)** and **Q2022 (UPC2713T)**, and passes through a low-pass filter. It is then fed to the TX/RX frequency mixer circuitry of the MAIN Unit.

2nd Local Oscillator Circuit

The 2nd LO circuit is a Hartley-type overtone oscillator circuit (frequency: 67.875 MHz) composed of **Q1052 (2SC4400-3)** on the MAIN Unit.

PLL Circuit

The PLL circuit is a frequency mixing type composed of a VCO, mixer, PLL IC, and loop filter. The VCO consists of five circuits (VCO1, VCO2, VCO3, VCO4 and VCO5), with a frequency range of 68.430-538.330 MHz divided into five bands, allocated to the five VCO circuits. VCO1-VCO5 consist mainly of FETs **Q2004**, **Q2005**, and **Q2006** (all **2SK210GR**); transistors **Q2009** and **Q2010** (both **2SC5374**); diodes **D2001-D2006** (all **HVC362**), **D2007 (1SV282)**, **D2008 (1SV281)**, and **D2009 (1SV286)**; and coils T2001-T2003, L2010, and L2011.

The VCO switching signal from the connector J2002 is used to drive switching transistors **Q2001**, **Q2002**, **Q2003**, **Q2012**, and **Q2013** (all **DTC124EU**) to switch the source terminal of the oscillator FET.

The 68.430-538.330 MHz VCO signal is buffer-amplified by **Q2023 (UPC1688G)**, and fed to PLL IC **Q2021 (FQ7925)**.

The REF-DDS signal (7.2-8.0 MHz) is fed to PLL IC **Q2021** after it passes through a low-pass filter composed of C2064, C2067, C2069, C2071, C2075, L2014, L2015, and L2016, and is fed to PLL IC **Q2021 (FQ7925)**. The phase of the reference frequency and that of the signal input to the PLL IC are compared, and a signal whose pulse corresponds to the phase difference is produced.

Alignment

Introduction and Precautions

The following procedures cover adjustments that are not normally required once the transceiver has left the factory. However, if damage occurs and some parts subsequently be replaced, realignment may be required. If a sudden problem occurs during normal operation, it is likely due to component failure; realignment should not be done until after the faulty component has been replaced.

We recommend that servicing be performed by authorized Vertex Standard service technicians, experienced with the circuitry and fully equipped for repair and alignment. If a fault is suspected, contact the selling dealer for instructions regarding repair. Authorized Vertex Standard service technicians have the latest configuration information, and realign all circuits and make complete performance checks to ensure compliance with factory specifications after repairs.

Those who do undertake any of the following alignments are cautioned to proceed at their own risk. Problems caused by unauthorized attempts at realignment are not covered by the warranty policy. Also, Vertex Standard must reserve the right to change circuits and alignment procedures in the interest of improved performance, without notifying owners.

Under no circumstances should any alignment be attempted unless the normal function and operation of the transceiver are clearly understood, the cause of the malfunction has been clearly pinpointed and any faulty components replaced, and the need for realignment determined to be absolutely necessary.

The following test equipment (and thorough familiarity with its correct use) is necessary for complete realignment. Most steps do not require all of the equipment listed, but the interactions of some adjustments may require that more complex adjustments be performed in a sequence. Do not attempt to perform only a single step unless it is clearly isolated electrically from all other steps. Rather, have all test equipment ready before beginning, and follow all of the steps in a section in the order they are presented.

Required Test Equipment

- Digital DC Voltmeter (high-Z, 1 M-Ohm/V)
- DC Ammeter
- RF Millivoltmeter
- AC Voltmeter
- RF Standard Signal Generator w/calibrated output and dB scale, $0 \text{ dB}\mu = 0.5\mu\text{V}$
- Signal Generator with calibrated output
- Spectrum Analyzer good to at least 1 GHz.
- Frequency Counter
- 50-Ohm Dummy Load (200 watts)
- 100-Ohm Dummy Load (200 watts)
- 150-Ohm Dummy Load (200 watts)
- In-Line Wattmeter (200 watts, 50-Ohm)
- Linear Detector
- RF Coupler

Alignment Preparation & Precautions

A 50-ohm RF Dummy load and in-line wattmeter must be connected to the main antenna jack in all procedures that call for transmission, except where specified otherwise. Correct alignment is not possible with an antenna.

After completing one step, read the following step to determine whether the same test equipment will be required. If not, remove the test equipment (except dummy load and wattmeter, if connected) before proceeding.

Correct alignment requires that the ambient temperature be the same as that of the transceiver and test equipment, and that this temperature be held constant between $68^\circ\text{F} \sim 86^\circ\text{F}$ ($20^\circ\text{C} \sim 30^\circ\text{C}$). When the transceiver is brought into the shop from hot or cold air, it should be allowed time to come to room temperature before alignment.

Whenever possible, alignments should be made with oscillator shields and circuit boards firmly affixed in place. Also, the test equipment must be thoroughly warmed up before beginning.

Note: Signal levels in dB referred to in this procedure are based on $0 \text{ dB}\mu = 0.5 \mu\text{V}$ (closed circuit).

Local Oscillator Adjustment

Reference Frequency Adjustment

1. Connect an RF millivoltmeter or an oscilloscope to pin 2 of **J5002** on the REF Unit.
2. Confirm that the RF millivoltmeter reading is 115 mV (± 30 mV) rms or 320 mV (± 90 mV) p-p.
3. Connect the frequency counter to pin 2 of **J5002** on the REF Unit.
4. Adjust the **TC5001** for 67.875000 MHz (± 10 Hz) on the frequency counter.

3rd Local Adjustment

1. Connect an RF millivoltmeter or an oscilloscope to **TP1037** on the MAIN Unit.
2. Key the transceiver on CW mode, and adjust **T1025** for maximum indication on the RF millivoltmeter.
3. Confirm that the indicated voltage is 100 mV (± 30 mV) rms or 280 mV (± 80 mV) p-p.

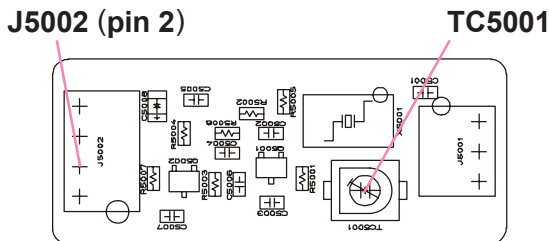

REF Unit Alignment Points

PLL Adjustment

VCO VCV Adjustment

1. Connect the DC voltmeter to **TP1028** on the MAIN Unit (or pin 6 of **J2002** on the PLL Unit), and referring to the table below, tune the transformer/inductor on the PLL Unit on each frequency listed. Then confirm that the correct voltage is present, or adjust the listed component for the required voltage.

| Tune to : | Adjust / Confirm | For |
|-------------|------------------|-------------------|
| 13.895 MHz | Adjust T2001 | 6.0 V ± 0.1 V |
| 76.000 MHz | Confirm | At least 0.9 V |
| 32.995 MHz | Adjust T2002 | 6.0 V ± 0.1 V |
| 13.900 MHz | Confirm | At least 0.9 V |
| 55.995 MHz | Adjust T2003 | 6.0 V ± 0.1 V |
| 88.000 MHz | Confirm | At least 0.9 V |
| 163.995 MHz | Adjust L2010 | 5.5 V ± 0.5 V |
| 118.000 MHz | Confirm | At least 0.8 V |
| 469.995 MHz | Adjust L2011 | 5.5 V ± 0.5 V |
| 420.000 MHz | Confirm | At least 0.8 V |

1st Local Output Level

1. Connect the RF millivoltmeter to **TP1029** on the MAIN Unit (or pin 11 of **J2002** on the PLL Unit), and set the transceiver to 28.000 MHz.
2. Confirm that the RF level is at least 0 dBm or 200 mV rms.

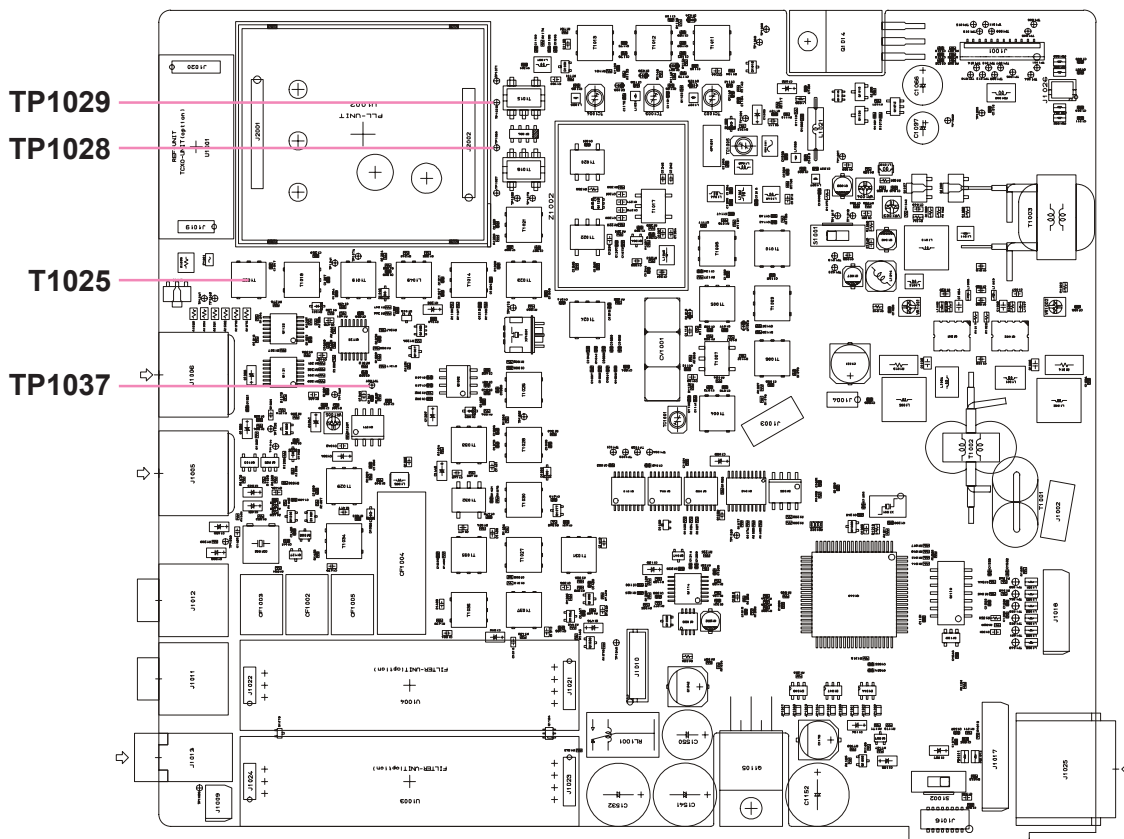

MAIN Unit Alignment Points I

Alignment

PLL Unlock

1. Connect the DC voltmeter to **TP1029** on the MAIN Unit (or pin 11 of **J2002** on the PLL Unit).
2. Disconnect the REF Unit from the MAIN Unit; confirm that the DC voltmeter shows less than 0.5 V and that “UNLOCK” is displayed on the LCD.
3. Re-connect the REF Unit to the MAIN Unit, and confirm that the DC voltmeter shows at least 3.5 V and that the LCD returns to its normal display.

Idling Current Adjustment

Before alignment, set the mode to CW and tune the transceiver to 1.800 MHz. Nothing should be connected to the CW Key Jack, and switch off **S1001** on the MAIN Unit.

Pre-Driver Stage Idling Current

1. Connect the ammeter between **TP1019** (+) and **TP1020** (-) on the MAIN Unit.
2. Press the PTT, and adjust **VR1004** for an indication of 30 mA (± 5 mA) on the ammeter.

Driver Stage Idling Current

1. Connect the ammeter between **TP1017** (+) and **TP1018** (-) on the MAIN Unit.
2. Press the PTT and adjust **VR1003** for an indication of 60 mA (± 5 mA) on the ammeter.

Exciter Stage Idling Current

1. Disconnect the Jumper Plug from **J1004** on the MAIN Unit, then connect the ammeter to **J1004** (pin 1: -, pin 1: +).
2. Turn both **VR1001** and **VR1002** fully counterclockwise.
3. Press the PTT and adjust **VR1002** for an indication of 50 mA (± 10 mA) on the ammeter.
4. Press the PTT and adjust **VR1001** for an indication of 100 mA (± 10 mA) on the ammeter.
5. Re-connect the Jumper Plug to **J1004** and switch on **S1001**.

TX IF Adjustment

SSB/CW TX IF Adjustment

1. Tune the frequency to the 14 MHz band. Connect the RF millivoltmeter to **TP1033** on the MAIN Unit.
2. Disconnect the Coaxial Cable from **J1002** and terminate **J1002** into a 50-Ohm dummy load.
3. Inject a 1 kHz tone at 1 mV level to the **MIC** jack.
4. Key the transmitter, and adjust **T1033** for maximum indication on the RF millivoltmeter.
5. Disconnect the 50-Ohm dummy load and re-connect the Coaxial Cable to **J1002**.

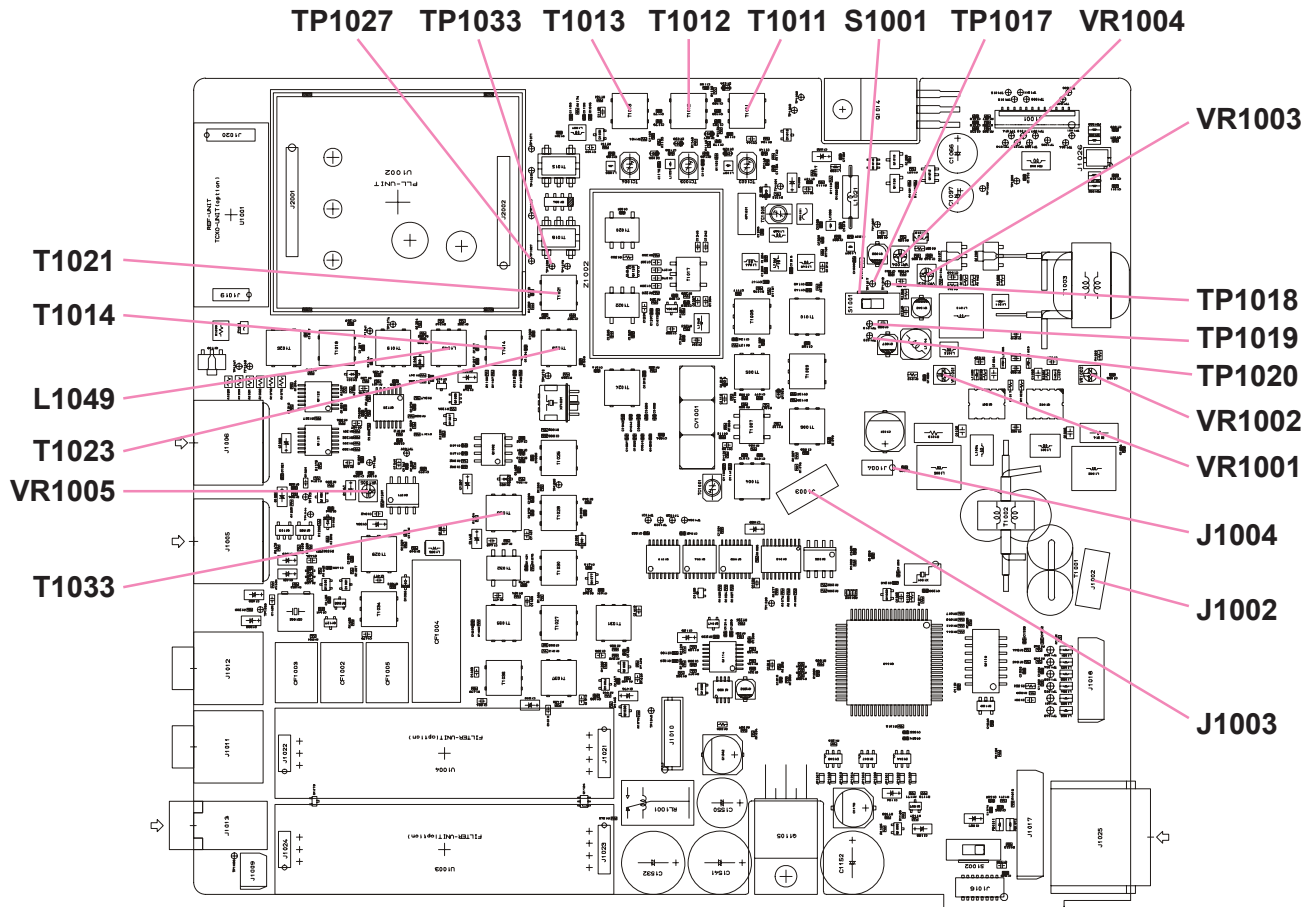
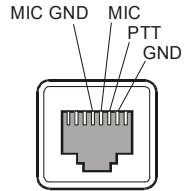

MAIN Unit Alignment Points II

FM TX IF Adjustment

1. Tune the frequency to the 28 MHz band. Connect the RF millivoltmeter to **TP1033** on the MAIN Unit.
2. Disconnect the Coaxial Cable from **J1002** and terminate **J1002** into a 50-Ohm dummy load.
3. Key the transmitter in the FM mode, and adjust **T1014** for maximum indication on the RF millivoltmeter.
4. Connect the frequency counter to **TP1033**.
5. Key the transmitter in the FM mode without microphone input. Adjust **L1049** for a reading of 68.3300 MHz (± 100 Hz).
6. Disconnect the 50-Ohm dummy load and re-connect the Coaxial Cable to **J1002**.

Carrier Balance Adjustment

1. Tune the frequency to the 14 MHz band. Disconnect the Coaxial Cable from **J1002** on the MAIN Unit.
2. Terminate **J1002** into a 50-Ohm dummy load and connect a spectrum analyzer or a RF millivoltmeter at this point.
3. Key the transmitter in the USB mode without microphone input. Adjust **VR1005** for maximum carrier suppression on the spectrum analyzer or for minimum indication on the RF millivoltmeter.
4. Disconnect the 50-Ohm dummy load and the spectrum analyzer or the RF millivoltmeter, and re-connect the Coaxial Cable to **J1002**.

TX BPF Adjustment

VHF TX BPF Adjustment

1. Set the frequency to 145.995 MHz. Disconnect the Coaxial Cable from **J1002** on the MAIN Unit.
2. Connect the spectrum analyzer to **J1002**, which should be terminated into a 50-Ohm dummy load.
3. Inject a 1 kHz tone at 1 mV level to the **MIC** jack.
4. Key the transceiver in the USB mode, and adjust **T1013**, **T1012**, and **T1011** alternately for maximum indication on the spectrum analyzer.
5. Disconnect the 50-Ohm dummy load and the spectrum analyzer, and re-connect the Coaxial Cable to **J1002**.

UHF TX BPF Adjustment

1. Set the frequency to 430.000 MHz. Disconnect the Coaxial Cable from **J1002** on the MAIN Unit.
2. Connect the spectrum analyzer to **J1002**, which should be terminated into a 50-Ohm dummy load.
3. Inject a 1 kHz tone at 1 mV level to the **MIC** jack.
4. Key the transceiver in the USB mode, and adjust **TC1004**, **TC1003** and **TC1002** alternately for maximum indication on the spectrum analyzer.
5. Disconnect the 50-Ohm dummy load and the spectrum analyzer, and re-connect the Coaxial Cable to **J1002**.

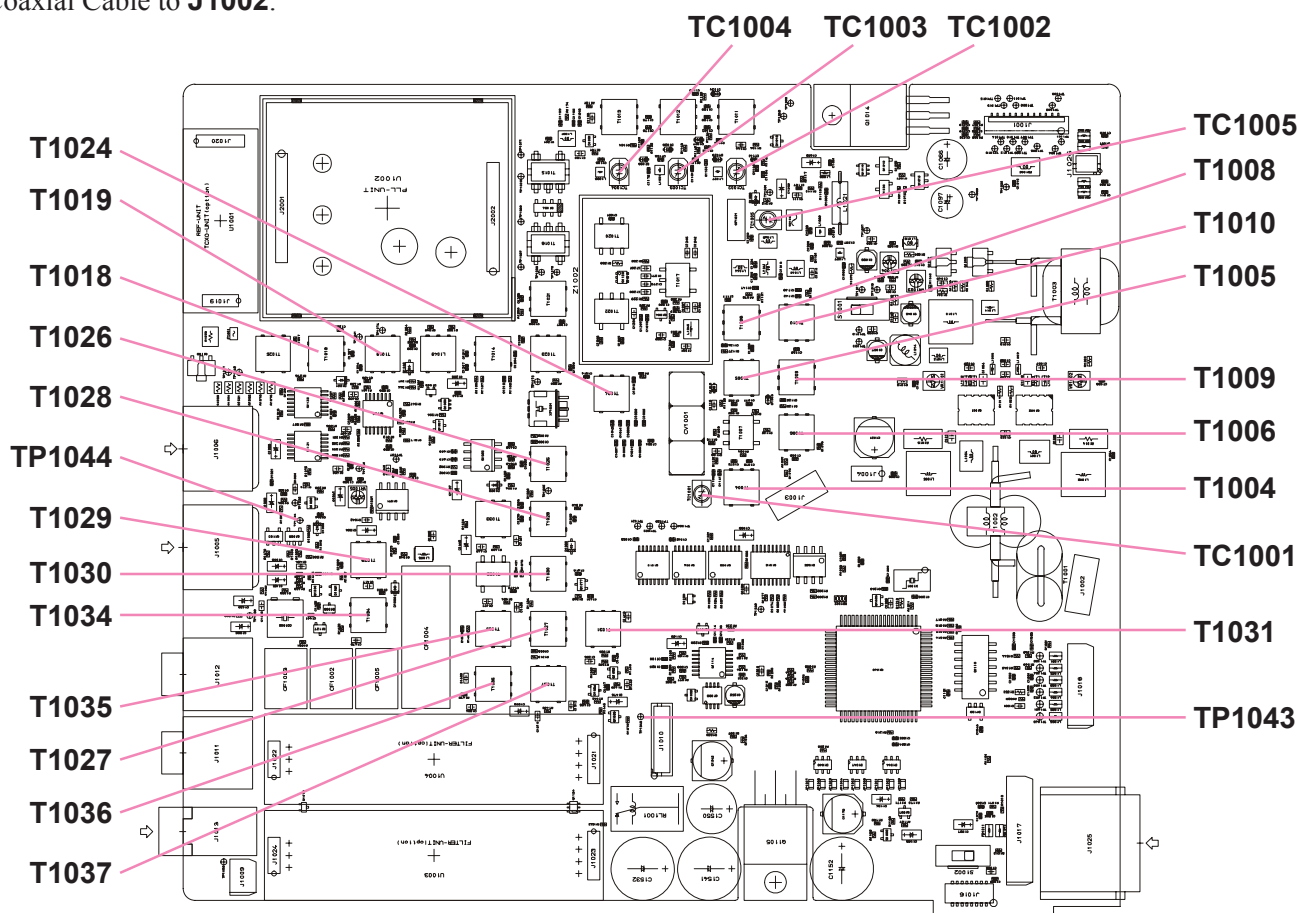

MAIN Unit Alignment Points III

Alignment

RX Adjustment

SSB IF Adjustment

1. Connect the signal generator to the HF/50 MHz antenna jack, and the AF millivoltmeter and the SINAD meter to the speaker jack.
2. Tune the transceiver to 51.995 MHz, and switch off the ATT and IPO feature. Inject a 51.995 MHz signal from a signal generator at 0 dB μ output.
3. Adjust **T1018**, **T1019**, **T1024**, **T1026**, **T1028**, **T1030**, **T1035**, **T1036**, **T1037**, **T1034** and **T1029** on the MAIN UNIT alternately for maximum indication on the AF millivoltmeter. Several passes may be necessary, as the adjustments inter-react to some degree.

FM IF Adjustment

1. Connect the signal generator to the HF/50 MHz antenna jack.
2. Tune the transceiver to 51.995 MHz. Inject a 51.995 MHz signal from a signal generator at 5 dB μ output, with 1 kHz AF FM modulation at ± 3.5 kHz deviation.
3. Adjust **T1024**, **T1026**, and **T1028** on the MAIN Unit alternately for maximum level on the S-meter.

Air-Band Reception Adjustment

1. Connect the signal generator to the HF/50 MHz antenna jack, and the DC voltmeter to **TP1044** on the MAIN Unit.
2. Tune the transceiver to 128.000 MHz in the AM mode. Inject a 128.000 MHz signal from the signal generator at 20 dB μ output, with 30% AM modulation at 400 Hz audio frequency.
3. Adjust **T1005** and **T1008** for minimum indication on the DC voltmeter.

VHF Band Alignment

1. Connect the signal generator to the 144/430 MHz antenna jack, and the DC voltmeter to **TP1044** on the MAIN Unit.
2. Tune the transceiver to 145.995 MHz in the CW mode. Inject a 145.995 MHz signal from a signal generator at 20 dB μ output.
3. Adjust **T1006**, **T1009**, and **T1010** alternately for minimum indication on the DC voltmeter.

UHF Band Alignment

1. Connect the signal generator to the 144/430 MHz antenna jack, and the DC voltmeter to **TP1044** on the MAIN Unit.
2. Tune the transceiver to 439.995 MHz in the CW mode. Inject a 439.995 MHz signal from the signal generator at 20 dB μ output.
3. Adjust **TC1001** for minimum indication on the DC voltmeter.

W-FM Reception Adjustment

1. Connect the signal generator to the 144/430 MHz antenna jack, and the SINAD meter to the speaker jack.
2. Tune the transceiver to 88.000 MHz. Inject an 88.000 MHz signal from the signal generator at 30dB μ output, with ± 22.5 kHz deviation FM modulation of a 1 kHz audio signal.
3. Adjust **TC1005** for the best SINAD sensitivity. Then reduce the output level of the signal generator to where the signal just begins to sound slightly “noisy,” and adjust **TC1005** again for best SINAD.

Image Rejection Trap Adjustment

1. Connect the signal generator to the HF/50 MHz antenna jack, the AF millivoltmeter to the speaker jack.
2. Tune the transceiver to 51.995 MHz in the FM mode. Inject a 68.330 MHz signal from a signal generator at 70 dB μ output, with 1 kHz AF FM modulation at ± 3.5 kHz deviation.
3. Adjust **T1004** for minimum indication on the AF millivoltmeter. Then increase the output level of the signal generator slightly and adjust **T1004** again, so as to ensure maximum notching of the image.

Noise Blanker Adjustment

1. Connect the signal generator to the HF/50 MHz antenna jack, and the DC voltmeter to **TP1043** on the MAIN Unit.
2. Tune the transceiver to 51.995 MHz and inject a 51.995 MHz signal from the signal generator at 20 dB μ output.
3. Activate the noise blanker, and adjust **T1027** and **T1031** for minimum indication on the DC voltmeter.

Power Amplifier Adjustment (Lot 1 ~ 59)

HF/50 MHz Idling Current Adjustment

1. Connect the 50-Ohm dummy load to the HF/50 MHz antenna jack.
2. Tune the transceiver to any HF band, or to the 50 MHz band.
3. Disconnect the wire jumper from **TP3025** and **TP3026** on the PA Unit, then connect the ammeter between **TP3025 (+)** and **TP3026 (-)**.
4. Turn **VR3001** fully counterclockwise.
5. Press the PTT, and adjust **VR3001** for an indication of 100 mA (± 10 mA) on the ammeter.
6. Disconnect the ammeter, and re-connect **TP3025** and **TP3026** using the wire jumper.

V/UHF Idling Current Adjustment

1. Connect the 50-Ohm dummy load to the 144/430 MHz antenna jack.
2. Tune the transceiver to the 430 MHz band.
3. Disconnect the wire jumper from **TP3025** and **TP3026** on the PA Unit, then connect the ammeter between **TP3025 (+)** and **TP3026 (-)**.
4. Turn **VR3002** fully counterclockwise.
5. Press the PTT, and adjust **VR3002** for an indication of 300 mA (± 10 mA) on the ammeter.
6. Disconnect the ammeter, and re-connect **TP3025** and **TP3026** using the wire jumper.

Directional Coupler Balance Adjustment

1. Connect the 50-Ohm dummy load to the HF/50 MHz antenna jack.
2. Tune the transceiver to 28 MHz band in the CW mode, and connect the DC voltmeter to **TP3003** on the PA Unit.
3. Press the PTT, and adjust **TC3002** for minimum indication on the DC voltmeter.
4. Connect the 50-Ohm dummy load and wattmeter to the 144/430 MHz antenna jack
5. Tune the transceiver to 439.995 MHz in the CW mode.
6. Press the PTT, and adjust **VR3003** for minimum indication on the DC voltmeter.
7. Leave the transceiver on 439.995 MHz band and key the transceiver.
8. Adjust **TC3001** for maximum indication on the wattmeter.

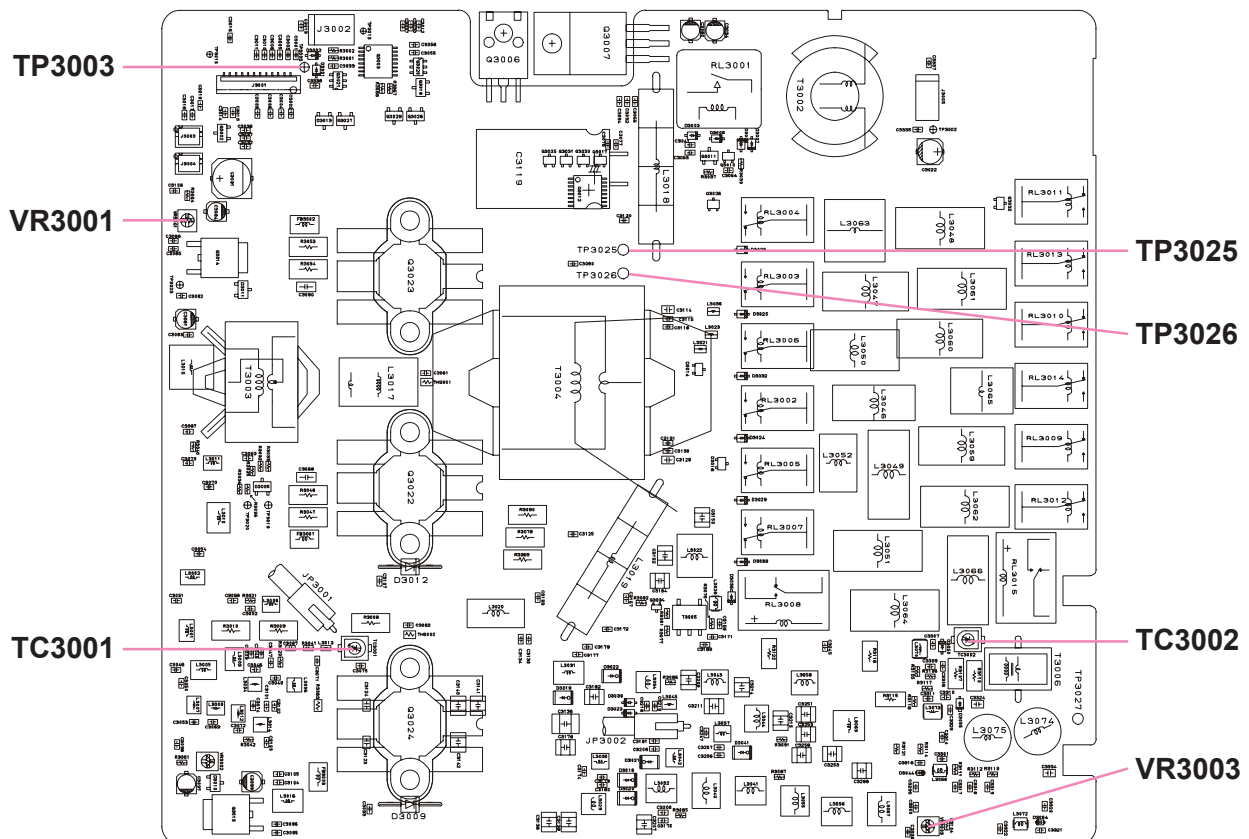

PA Unit (Lot 1 ~ 59) Alignment Points

Alignment

LCD Contrast Alignment

1. Connect a DC voltmeter (High Impedance) to **TP4027** on the PANEL Unit.
2. Adjust **VR4001** for an indication of $-2.54\text{ V} (\pm 0.02\text{ V})$ on the voltmeter.

Software Menu Alignment

The antenna jacks should be connected to a dummy load (in cases where transmission is involved) or the signal generator (in the case of reception). General alignment conditions are as follows unless otherwise noted.

AF-gain knob: Center
RF-gain knob: Fully clockwise
SQL: Fully counterclockwise
ATT/IPO/CTCSS/DCS: Off
AGC: Auto
Output power: Max
Break-in: On,
CW Keyer: Off
VOX: Off

Press and hold in three Multi Function Keys ([**A**], [**B**], [**C**]) simultaneously and turn on the transceiver while holding them in; the alignment menu will then be activated (you will hear a “diddle-diddle-diddle” opening tone sequence to confirm that the alignment menu has been activated).

In the alignment procedures, each alignment parameter is selected by rotating the main **DIAL** knob. Each Alignment item is then selected by rotating the **SELECT** knob.

To store the alignment parameters when you are satisfied with the adjustment, press the [**FUNC**] key for longer than a one second.

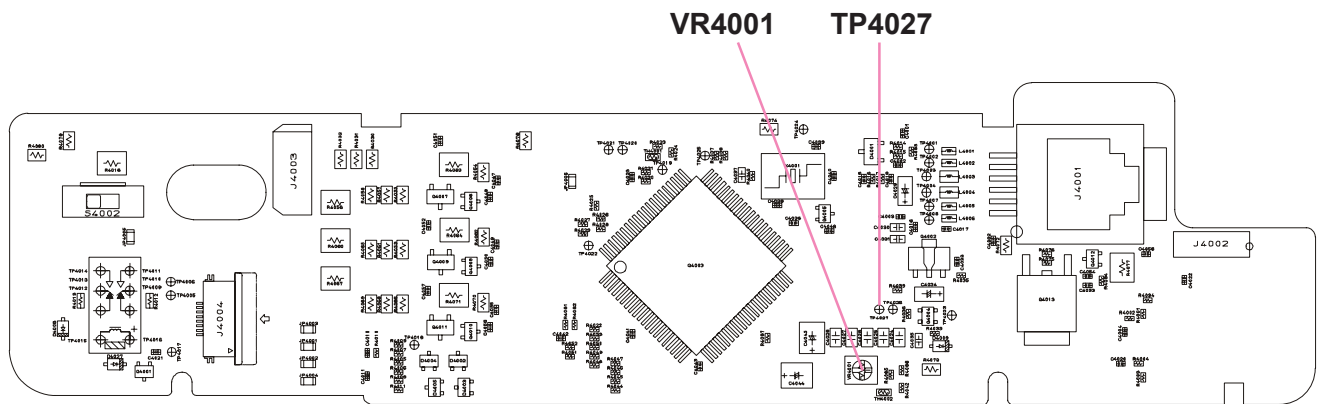

PANEL Unit Alignment Points

Alignment

RX Gain Adjustment

1. Tune the transceiver to the 1.8 MHz band in the CW mode.
2. Select “**HF1RXG**” in the menu by rotating the **SELECT** knob, if necessary.
3. Inject an RF signal from the signal generator at 9 dB μ output.
4. Adjust the “**HF1RXG**” parameter by rotating the main **DIAL** knob to the point where the S-meter indicates “S1.”
5. The other RX gain adjustments (see the chart below) should be performed in the same way. The output levels of the signal generator at each frequency are shown below.

| Menu | Frequency | Output Level of SG |
|-------------------|--------------|--------------------|
| 01: HF1RXG | 1.8 MHz Band | 9 dB μ |
| 02: HF2RXG | 7 MHz Band | 9 dB μ |
| 03: HF3RXG | 21 MHz Band | 6 dB μ |
| 04: 50MRXG | 50 MHz Band | 3 dB μ |
| 05: VHFRXG | 144 MHz Band | 0 dB μ |
| 06: UHFRXG | 430 MHz Band | 0 dB μ |

SSB S-Meter Adjustment

1. Tune the transceiver to the 21 MHz band in the CW mode.
2. Inject an RF signal from the signal generator at 36 dB μ output.
3. Select menu item “**07: SSB-SS**” and press the **[A]** key to set this parameter.
4. Increase the signal generator output level to 86 dB μ .
5. Select menu item “**08: SSB-FS**” and press the **[A]** key to set this parameter.

FM S-Meter Adjustment

1. Tune the transceiver to the 144 MHz band in the FM mode.
2. Inject an RF signal from the signal generator at 0 dB μ output, with ± 3.5 kHz deviation FM Modulation of a 1 kHz tone.
3. Select menu item “**09: FM-S1**” and press the **[A]** key to set this parameter.
4. Increase the signal generator output level to 25 dB μ .
5. Select menu item “**10: FM-FS**” and press the **[A]** key to set this parameter.

FM Center Meter Adjustment

1. Tune the transceiver to the 144 MHz band in the FM mode.
2. Inject an RF signal from the signal generator at 10 dB μ output, with ± 3.5 kHz deviation FM Modulation of a 1 kHz tone.
3. Set the frequency of the signal generator 3 kHz below the receiving frequency of the transceiver.
4. Select menu item “**11: DISC-L**” and press the **[A]** key to set this parameter.
5. Set the frequency of the signal generator 3 kHz above the receiving frequency of the transceiver.
6. Select menu item “**12: DISC-H**” and press the **[A]** key to set this parameter.

FM Squelch Adjustment

1. Tune the transceiver to the 144 MHz band in the FM mode. Confirm that the squelch knob is turned fully counterclockwise.
2. Inject an RF signal from the signal generator at -15 dB μ output, with ± 3.5 kHz deviation FM Modulation of a 1 kHz tone.
3. Select menu item “**13: FM-TH1**” and press the **[A]** key to set this parameter.
4. Select menu item “**14: FM-TH2**” and press the **[A]** key again.
5. Increase the signal generator output level to 0 dB μ .
6. Select menu item “**15: FM-TI1**” and press the **[A]** key to set this parameter.
7. Select menu item “**16: FM-TI2**” and press the **[A]** key again.

Power Supply Voltage Display Adjustment

1. Tune the transceiver to the 144 MHz band in the FM mode. Confirm that the power supply voltage is 13.8 V (± 0.1 V).
2. Select menu item “**17: VCC**” and adjust this parameter such that “**138**” is displayed on the LCD.

Over-current Protection Adjustment

1. Set the transceiver to the CW mode.
2. Select menu item “**18: HF1-IC.**” Tune the transceiver to the 1.8 MHz band and key the transceiver. Adjust this parameter for 140 Watts of transmission power.
3. Select menu item “**19: HF2-IC.**” Tune the transceiver to the 7 MHz band and key the transceiver. Adjust this parameter for 130 Watts of transmission power.
4. Select menu item “**20: HF3-IC.**” Tune the transceiver to the 21 MHz band and key the transceiver. Adjust this parameter for 130 Watts of transmission power.
5. Select menu item “**21: 50M-IC.**” Tune the transceiver to the 50 MHz band and key the transceiver. Adjust this parameter for 120 Watts of transmission power.
6. Select menu item “**22: VHF-IC.**” Tune the transceiver to the 144 MHz band and key the transceiver. Adjust this parameter for 60 Watts of transmission power.
7. Select menu item “**23: UHF-IC.**” Tune the transceiver to 430.000 MHz and key the transceiver. Adjust this parameter for 25 Watts of transmission power.

RF Power Adjustment

1. Tune the transceiver to the 1.8 MHz band in the CW mode.
2. Select menu item “**24: HF1-MAX.**” Key the transmitter, and adjust this parameter for 100 Watts (± 5 W) of transmission power.
3. Select menu item “**25: HF1-MID2.**” Key the transmitter, and confirm that the output power is 50 W (± 5 W). In case the transmission power is not within the specified tolerance, adjust this parameter for 50 W (± 5 W) of transmission power.
4. Select menu item “**26: HF1-MID1.**” Key the transmitter, and confirm that the output power is 10 W (± 1 W). In case the power is not within the specified tolerance, adjust this parameter for 10 W (± 1 W) of transmission power.
5. Select menu item “**27: HF1-MIN.**” Key the transmitter, and confirm that the output power is 5 W (± 1 W). In case the power is not within the specified tolerance, adjust this parameter for 5 W (± 1 W) of transmission power.
6. The other RF power adjustment menus, [**HF2-****] and [**HF3-****], should be adjusted in the same manner as shown above for the 7 MHz and 21 MHz bands respectively.
7. Tune the transceiver to the 50 MHz band in the CW mode.
8. Select menu item “**36: 50M-MAX.**” Key the transmitter, and adjust this parameter for 100 W (± 5 W) of transmission power.
9. Select menu item “**37: 50M-MID2.**” Key the transmitter, and confirm that the output power is 50 W (± 5 W). In case the transmission power is not within the specified tolerance, adjust this parameter for 50 W (± 5 W) of transmission power.
10. Select menu item “**38: 50M-MID1.**” Key the transmitter, and confirm that the output power is 20 W (± 2 W). In case the power is not within the specified tolerance, adjust this parameter for 20 W (± 2 W) of transmission power.
11. Select menu item “**39: 50M-MIN.**” Key the transmitter, and confirm that the output power is 5 W ($+0/-1$ W). In case the power is not within the specified tolerance, adjust this parameter for 5 W ($+0/-1$ W) of transmission power.
12. Tune the transceiver to the 144 MHz band in the CW mode.
13. Select menu item “**40: VHF-MAX.**” Key the transmitter, and adjust this parameter for 50 W (± 2.5 W) of transmission power.

Alignment

14. Select menu item “**41: VHF-MID.**” Key the transmitter, and confirm that the output power is 20 W (± 2 W). In case the transmission power is not within the specified tolerance, adjust this parameter for 20 W (± 2 W) of transmission power.
15. Select menu item “**42: VHF-MIN.**” Key the transmitter, and confirm that the output power is 5 W ($+0/-1$ W). In case the power is not within the specified tolerance, adjust this parameter for 5 W ($+0/-1$ W) of transmission power.
16. Tune the transceiver to the 430 MHz band in the CW mode.
17. Select menu item “**43: UHF-MAX.**” Key the transmitter, and adjust this parameter for 20 W (± 1 W) of transmission power.
18. Select menu item “**44: UHF-MID.**” Key the transmitter, and confirm that the output power is 2 W (± 0.3 W). In case the transmission power is not within the specified tolerance, adjust this parameter for 2 W (± 0.3 W) of transmission power.

TX Gain Adjustment

1. Set the transceiver to the USB mode.
2. Inject a 1 kHz tone at 1 mV level to the MIC jack.
3. Tune the transceiver to the 1.8 MHz band.
4. Select menu item “**45: HF1TXG.**” Key the transmitter, and adjust this parameter for 70 W (± 10 W) of transmission power.
5. The other TX gain adjustment menus, “**46: HF2TXG,**” “**47: HF3TXG,**” and “**48: 50MTXG,**” should be adjusted in the same manner as detailed above on the 7 MHz, 21 MHz, and 50 MHz bands, respectively.
6. Tune the transceiver to the 144 MHz band.
7. Select menu item “**49: VHF-TXG.**” Key the transmitter and adjust this parameter for 35 W (± 5 W) of transmission power.
8. Tune the transceiver to the 430 MHz band.
9. Select menu item “**50: UHFTXG.**” Key the transmitter and adjust this parameter for 10 W (± 2 W) of transmission power.

ALC (Automatic Level Control) Meter Adjustment

1. Tune the transceiver to the 21 MHz band in the USB mode.
2. Select menu item “**51: ALC-1.**” Key the transceiver without microphone input and press the [A] key. Now, a value which the microprocessor computes will be displayed on the LCD.
3. Rotate the main **DIAL** knob to adjust this parameter to a reading four digits lower than the parameter value displayed in the previous step.
4. After setting the parameter, confirm that all the dots of the ALC meter have gone out.
5. Select menu item “**52: ALC-M.**” 1 kHz tone at 4 mV level to the **MIC** jack.
6. Press the [A] key and confirm that the ALC meter shows an “S-8” S-meter reading on the LCD.

AFP (Automatic Final Protection) Adjustment

1. Tune the transceiver to the 1.8 MHz band in the CW mode, and connect a 150-Ohm dummy load to the antenna jack.
2. Select menu item “**53: HF1-RV.**” Key the transmitter, and adjust this parameter for an “S-8” S-meter reading on the LCD.
3. The other AFP adjustment menus, “**54: HF2-RV,**” “**55: HF3-RV,**” and “**56: 50M-RV,**” should be adjusted in the same manner as shown above on the 7 MHz, 21 MHz, and 50 MHz bands, respectively.
4. Tune the transceiver to the 144 MHz band.
5. Select menu item “**57: VHF-RV.**” Key the transmitter, and adjust this parameter for an “S-6” S-meter reading on the LCD.
6. Tune the transceiver to the 430 MHz band.
7. Select menu item “**58: UHF-RV.**” Key the transmitter, and adjust this parameter for an “S-3” S-meter reading on the LCD.

Carrier Level Adjustment

1. Tune the transceiver to the 21 MHz band in the CW mode.
2. Connect a 50-Ohm dummy load to the HF/50MHz antenna jack.
8. Select menu item “**59: CW-CAR.**” Key the transmitter, and adjust this parameter for an “S-9” S-meter reading on the LCD.
3. Connect the oscilloscope to the HF/50MHz antenna jack via an appropriate attenuator.
4. Set the transceiver to the AM mode.
5. Inject a 1 kHz tone at 1 mV level to the **MIC** jack.
6. Select menu item “**60: AM-CAR.**” Key the transmitter, and adjust this parameter for 33% AM modulation on the oscilloscope.

FM Modulation Adjustment

1. Tune the transceiver to the 144 MHz band in the FM mode. Connect the FM linear detector to the 144/430 MHz antenna jack via an appropriate attenuator.
2. Inject a 1 kHz tone at 15 mV level to the **MIC** jack.
3. Select menu item “**61: DEV-W.**” Key the transmitter, and adjust this parameter for a maximum deviation of ± 4.5 kHz (± 0.2 kHz) on the FM linear detector.
4. Select menu item to “**62: DEV-N.**” Key the transmitter, and adjust this parameter for maximum deviation of ± 2.25 kHz (± 0.1 kHz) on the FM linear detector.
5. Select menu item to “**63: M-MTR.**” Key the transmitter, and set this parameter for an “S-9” indication on the S-meter on the LCD.
6. Select menu item to “**64: DTMF.**” Key the transmitter, and adjust this parameter for a maximum deviation of ± 3.5 kHz (± 0.3 kHz) on the FM linear detector (the transceiver generates the DTMF “D” tone automatically while the menu item selected is “**64: DTMF.**”).
7. Select menu item to “**65: CTCSS.**” Key the transmitter without microphone input, and adjust this parameter for a maximum deviation of ± 0.7 kHz (± 0.1 kHz) on the FM linear detector (the transceiver generates a CTCSS tone automatically while the menu item selected is “**65: CTCSS.**”).
8. Select menu item to “**66: DCS.**” Key the transmitter without microphone input, and adjust this parameter for a maximum deviation of ± 0.7 kHz (± 0.2 kHz) on the FM linear detector (the transceiver generates a DCS tone automatically while the menu item selected is “**66: DCS.**”).

SSB Carrier Point Adjustment

1. Tune the transceiver to the 21 MHz band in the LSB mode.
2. Connect a 50-Ohm dummy load and wattmeter to the HF/50MHz antenna jack.
3. Inject a 400 Hz tone at 1 mV level to the **MIC** jack.
4. Select menu item “**67: LSB-CP.**” Key the transmitter, and adjust the audio generator output so that the transmission power is 20 Watts.
5. Change the audio frequency to 2600 Hz. Key the transmitter, and adjust this parameter so that the transmission power is 20 W (± 2 W).
6. The adjustment for the USB carrier point is performed in the same manner as done for LSB by changing the transmission mode to USB and the menu item to “**68: USB-CP.**”

VSWR Adjustment

1. Connect a 100-Ohm dummy load to the HF/50 MHz antenna jack.
2. Tune the transceiver to the 14 MHz band in the CW mode, and set the output power to 10 Watts.
3. Select menu item “**69: SWR2.**” Key the transceiver and press the **[A]** key to set this parameter.
4. Connect a 150-Ohm dummy load to the HF/50 MHz antenna jack, and set the output power to 10 Watts.
5. Select menu item “**70: SWR3.**” Key the transceiver and press the **[A]** key to set this parameter.

ATAS control voltage confirmation

1. Connect the DC voltmeter to the HF/50 MHz antenna jack.
2. Select menu item “**71: ATAS.**”
3. Press the **[A]** key, and confirm that the voltage is 9.0 to 10.1 Volts.
4. Press the **[B]** key, and confirm that the voltage is 7.5 to 8.5 Volts.
5. Press the **[C]** key, and confirm that the voltage is more than 10.5 Volts.

This completes the internal alignment routine for all bands. To save all settings and exit, press and hold in the **[FUNC]** key for at least one second.

Alignment

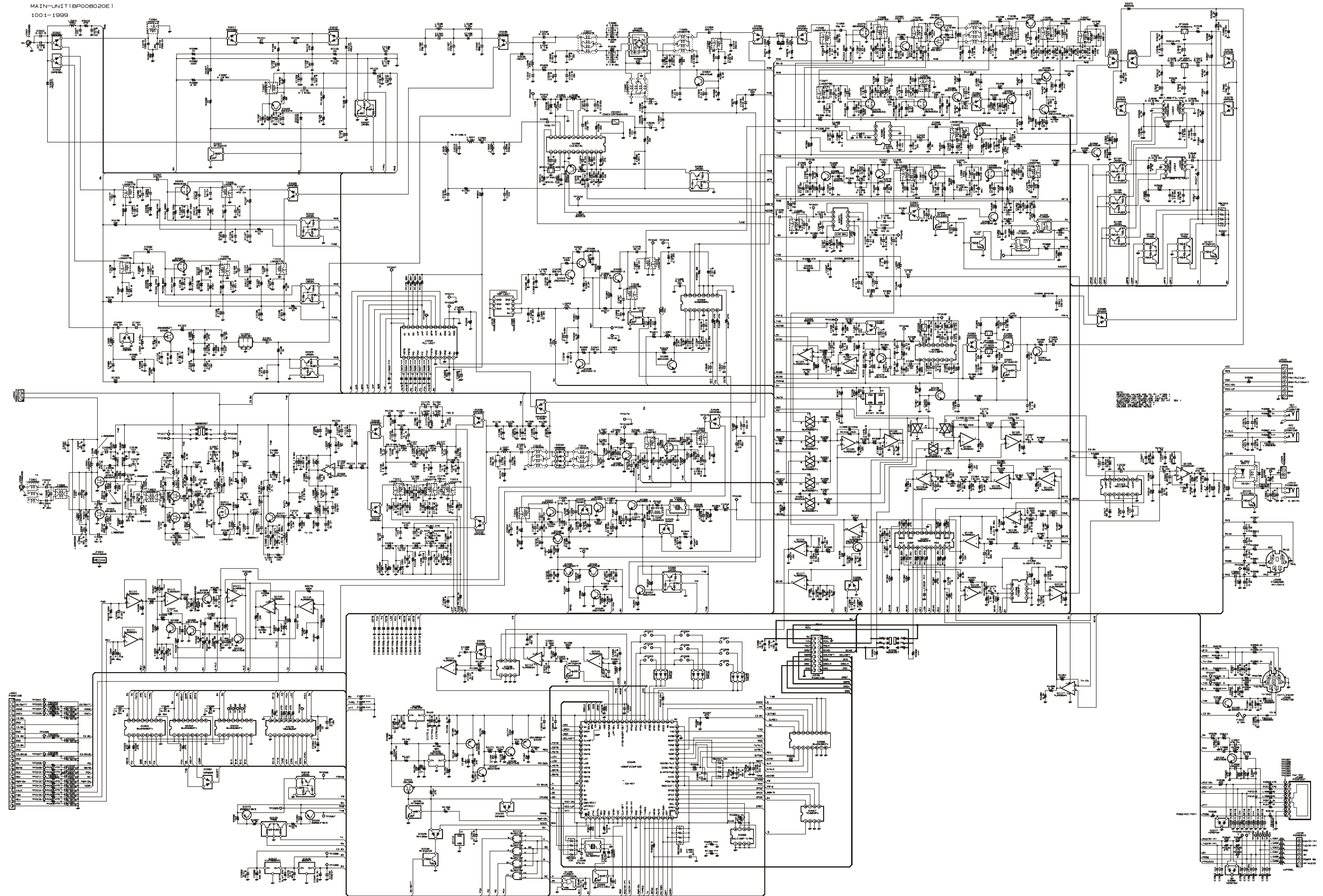

MAIN Unit (Lot 1 ~ 17)

Note:

MAIN Unit (Lot 1 ~ 17)

Parts Layout (Side B)

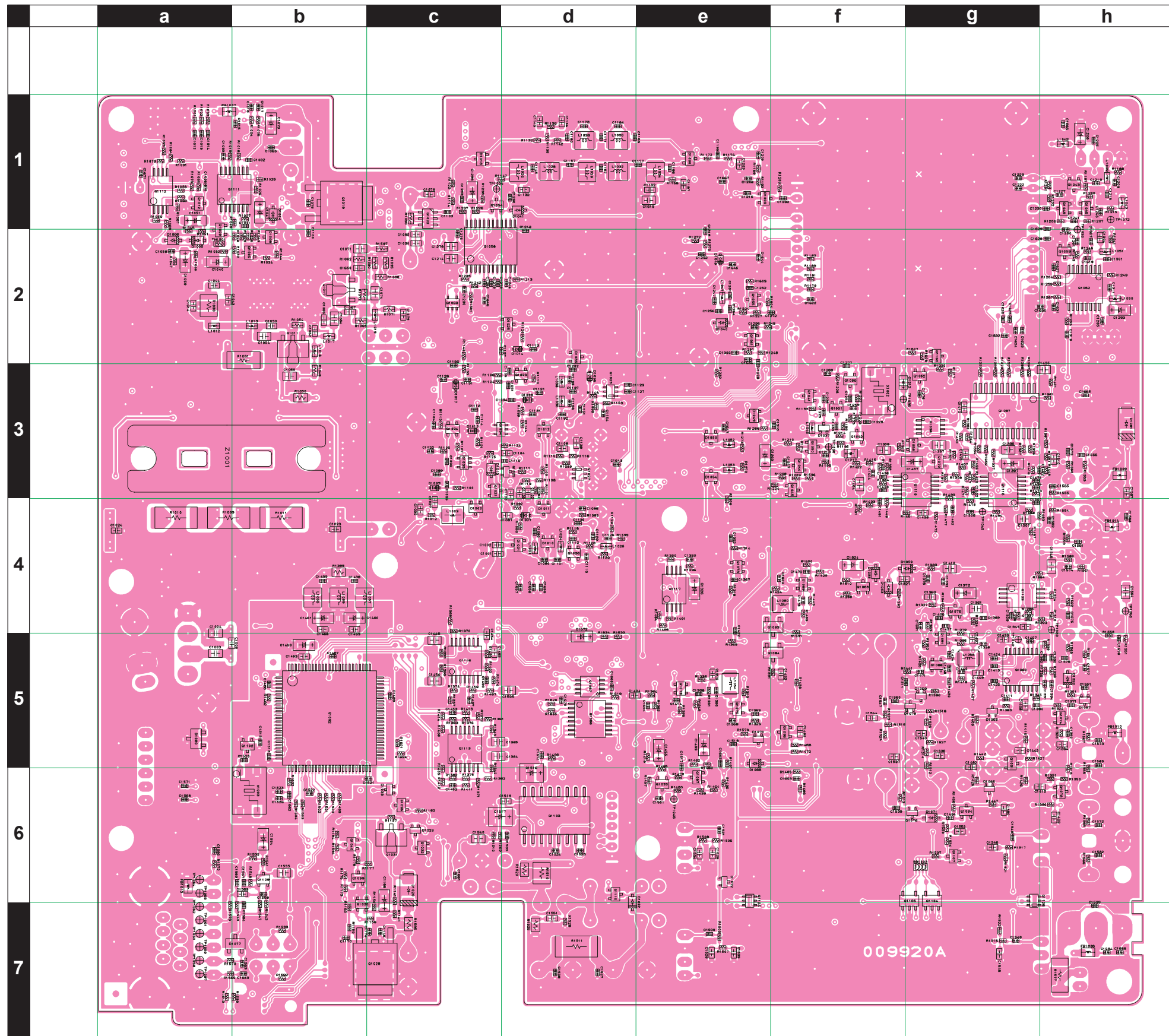

| | | | |
|------------------------------------------------------------------|-------------------------------------------------------------------------------------|-----------------------------------------------------------------------------------------------------------------------------------|------------------------------------------------------------------------------|
| Pin 24 Pin 12 Pin 1 | Pin 16 Pin 8 Pin 1 | Pin 14 Pin 7 Pin 1 | Pin 8 Pin 4 Pin 1 |
| CXA1611N (Q1058) M62364FP (Q1087) | AD9835BRU (Q1062) BU4053BCFV-E2 (Q1066) M51132FP (Q1103) TA31136FN (Q1080) | NJM2902V (Q1111, 1118, 1119) | NJM2904V (Q1112, 1117, 1123) TC4W53FU (Q1067, 1098) |
| Drain Gate Source | Source Gate Drain | Source Gate Drain | Source Drain Gate |
| 2SJ355 (PQ) (Q1031) | 2SK2596 (BX) (Q1011) | 2SK2685 (WV-) (Q1026) | 2SK302Y (TY) (Q1083, 1084) |
| Collector Base Emitter | Collector Base Emitter | Collector Base Emitter | GND IN OUT |
| 2SA1602A (MF) (Q1040, 1050, 1099) | 2SC3357 (RK) (Q1017) | 2SC4154E (LE) (Q1005, 1008, 1009, 1012, 1039, 1042, 1044, 1045, 1054, 1055, 1068, 1070, 1074, 1076, 1078, 1094, 1096, 1097, 1109) | BA05FP (Q) (Q1019, 1028) |
| Gate 2 Gate 1 Drain Source | Collector Base Emitter | 2SC4400 (RT) (Q1041, 1043, 1046, 1048, 1051, 1052, 1056, 1059) | V _{OUT} GND V _A |
| BB305CEW (EW) (Q1073, 1075, 1079, 1081, 1088) | DTC114EU (24) (Q1110) | 2SC5374 (NA) (Q1025) | M5278L05M (Q1028) |
| V _{SS} V _{DD} V _{OUT} NC | Collector Base Emitter | Pin 3 Pin 2 Pin 1 Pin 4 Pin 5 | Base 2 Collector 1 Emitter 2 Emitter 1 Collector 2 Base 1 |
| PST3445UR (DF) (Q1030) | RT1N241M (N2) (Q1021, 1032, 1035, 1091, 1107) | UMC5N (C5) (Q1033, 1034, 1063) | UMD2N (D2) (Q1029) |
| GND IN OUT V _{CC} GND | Anode 1, Cathode 2 Cathode 1, Anode 2 | Cathode 1, Anode 2 Anode 1, Cathode 2 | Cathode 1,2 Anode 1, Anode 2 |
| UPC2710T (C1F) (Q1022) | 1SS302 (C3) (D1010) | 1SS372 (N9) (D1058) DA221 (K) (D1037, 1057) | DAN222 (N) (D1033, 1069, 1070) |
| | Anode 1,2 Cathode 1, Cathode 2 | Cathode 1,2 Anode 1, Anode 2 | Anode 1,2 Cathode 1, Cathode 2 |
| | DAP222 (P) (D1063, 1065, 1072, 1076, 1078) | DAN235U (M) (D1039, 1049, 1050, 1054) | DAP236U (X) (D1001, 1002, 1011, 1012, 1018, 1025, 1030, 1035) |
| | Anode 1,2 Cathode 1, Cathode 2 | MA132WK (MU) (D1029) | HZM27WA (27A) (D1077, 1080) |

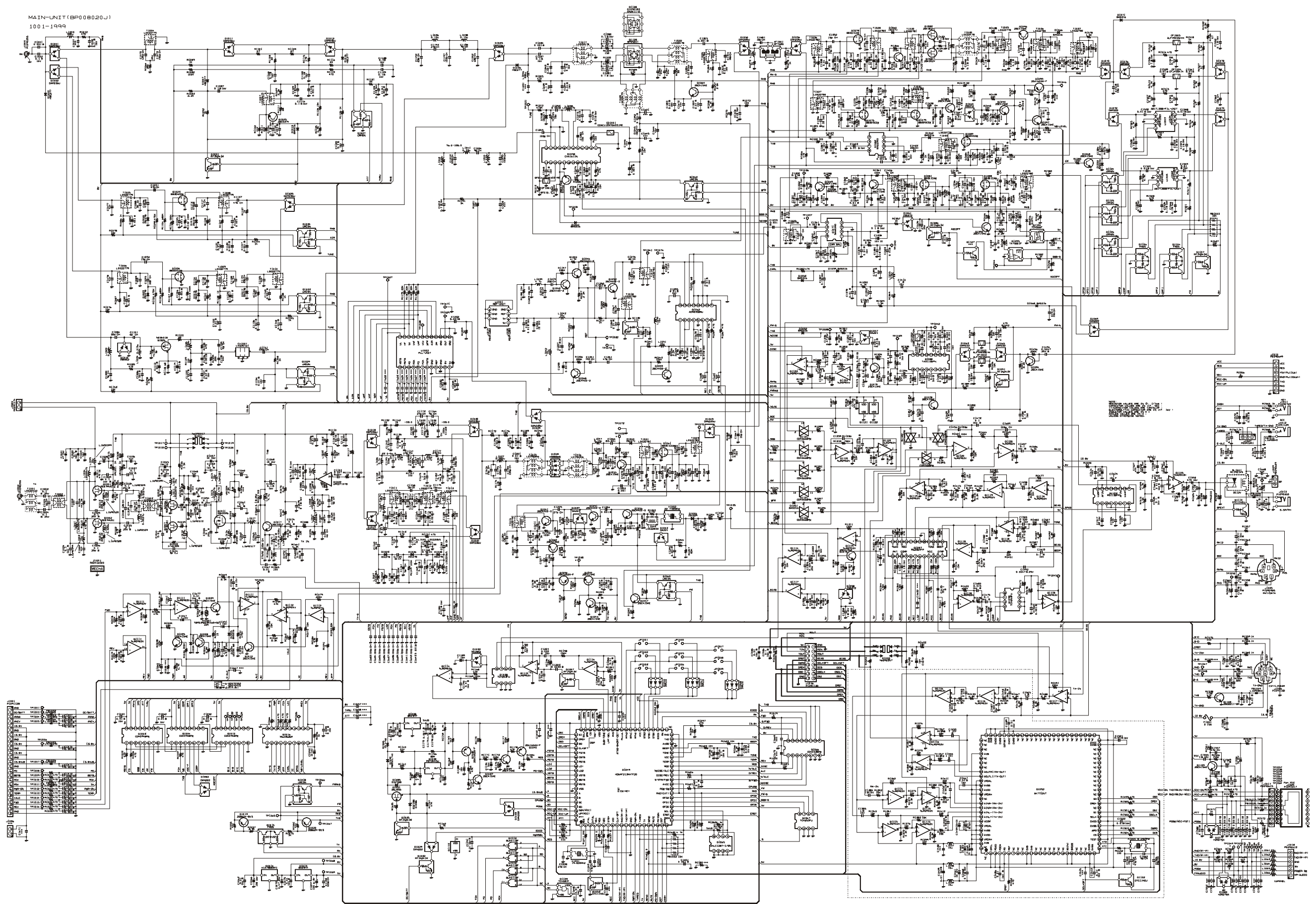

MAIN Unit (Lot 18 ~ 39)

Note:

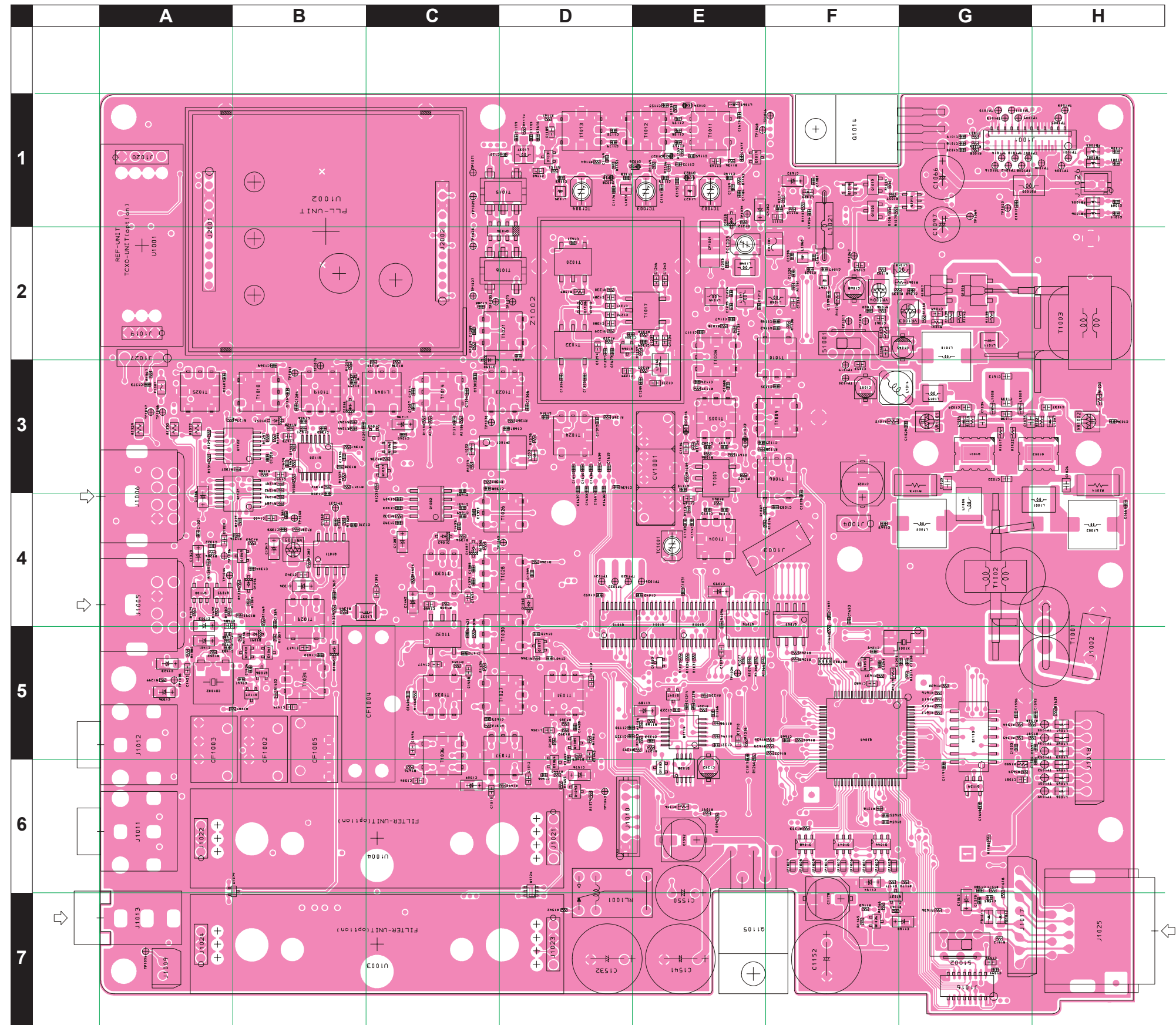
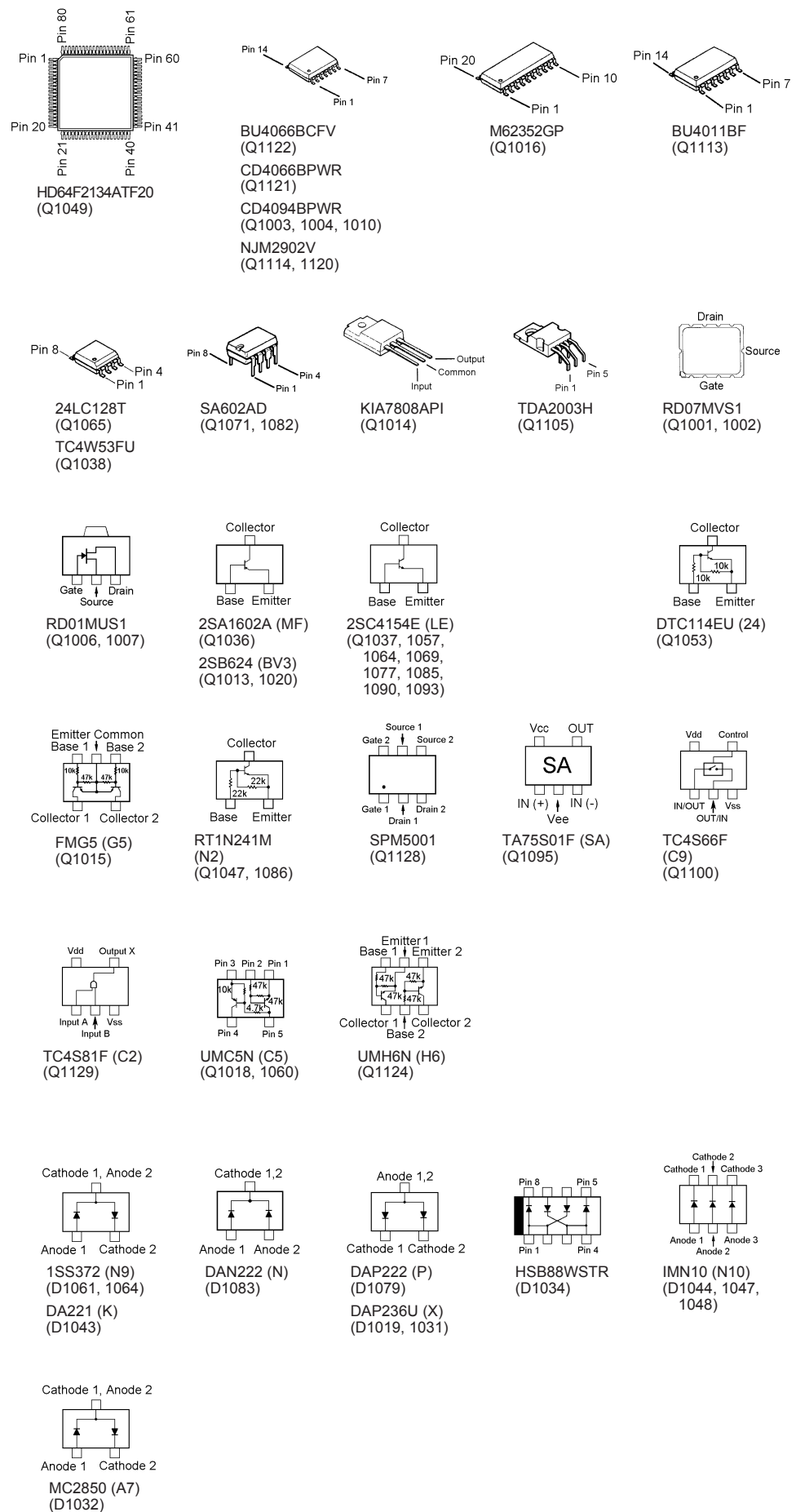

MAIN Unit (Lot 18 ~ 39)

Parts Layout (Side B)

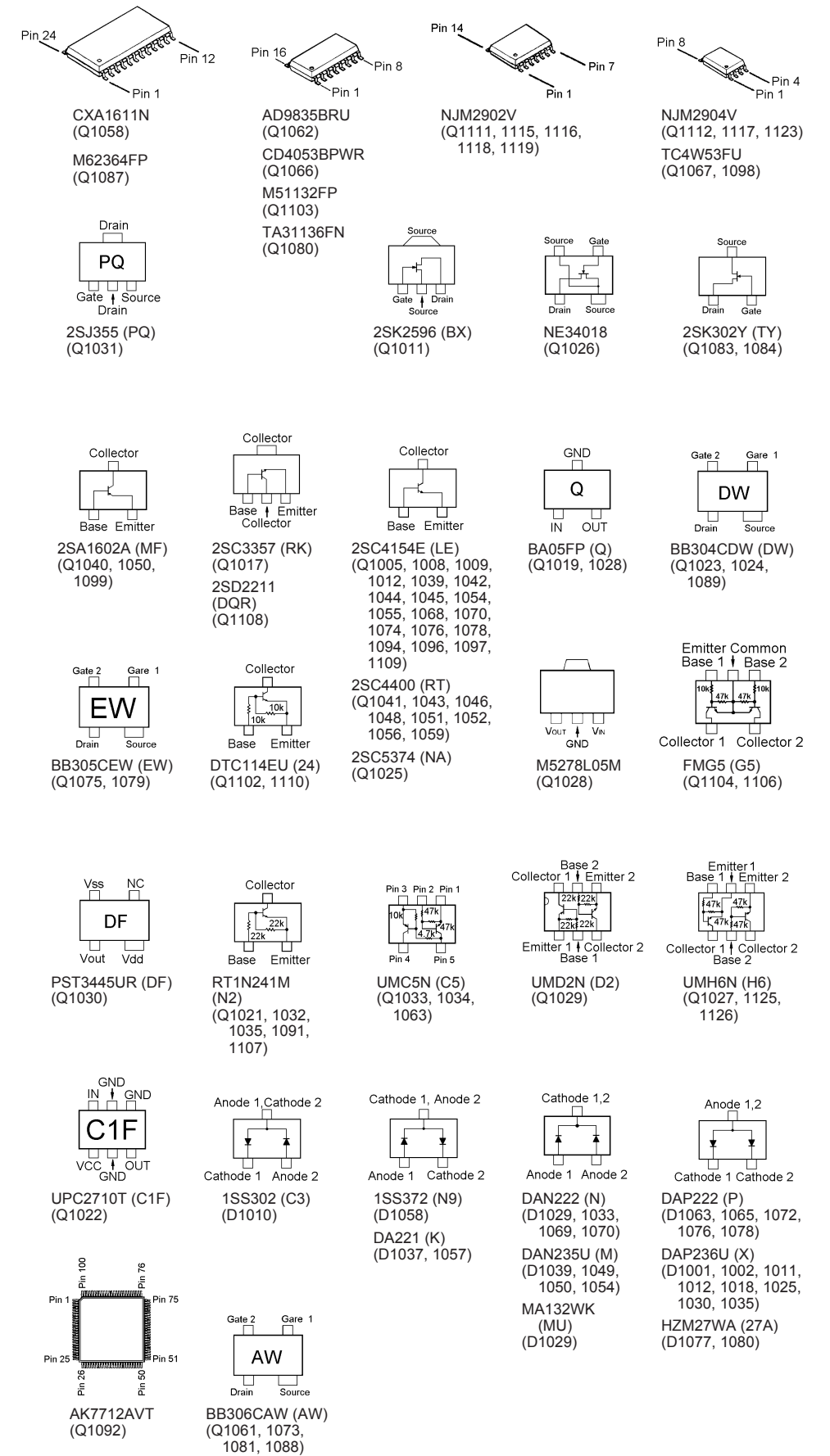
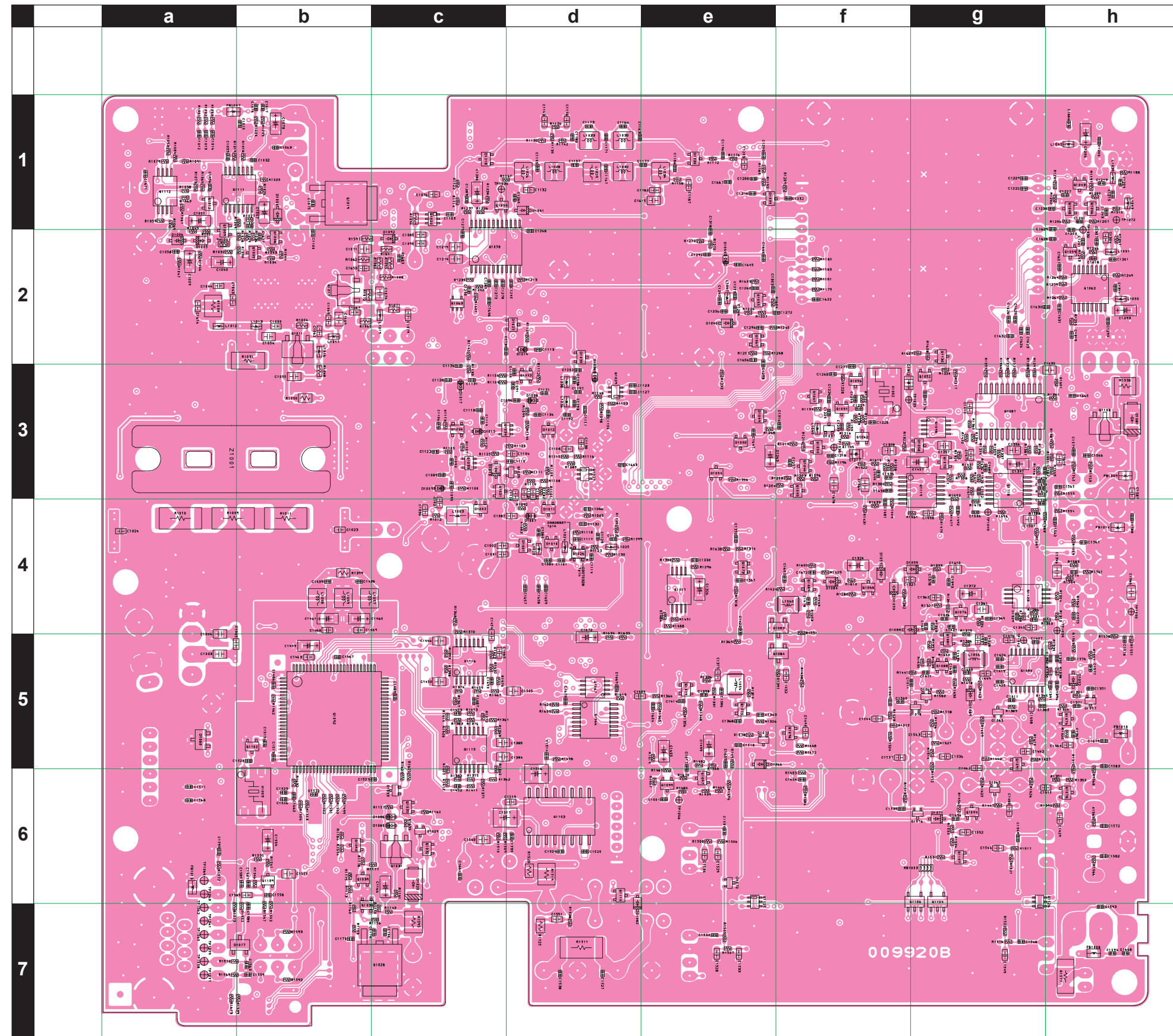

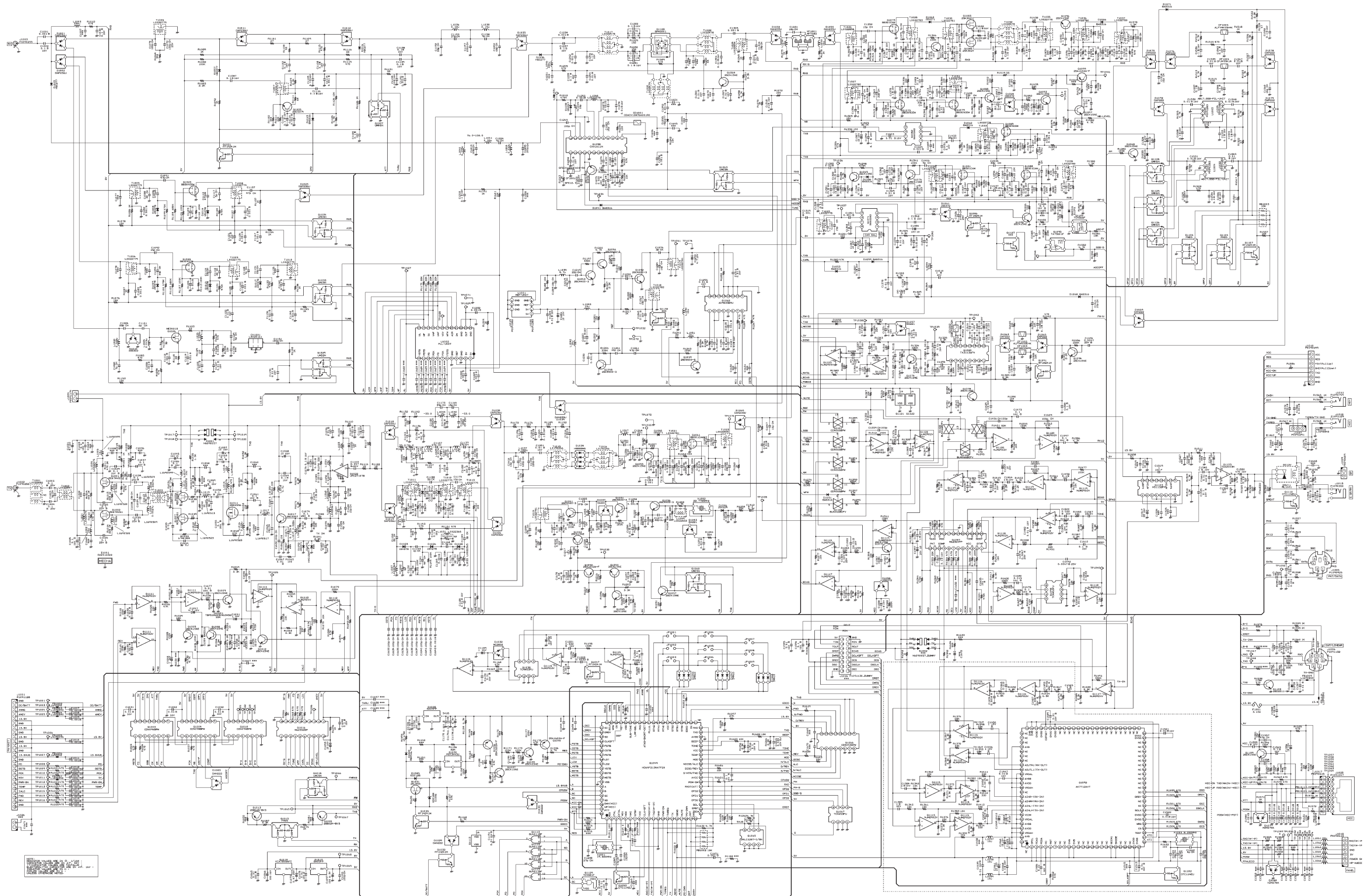

MAIN Unit (Lot 40 ~)

Note:

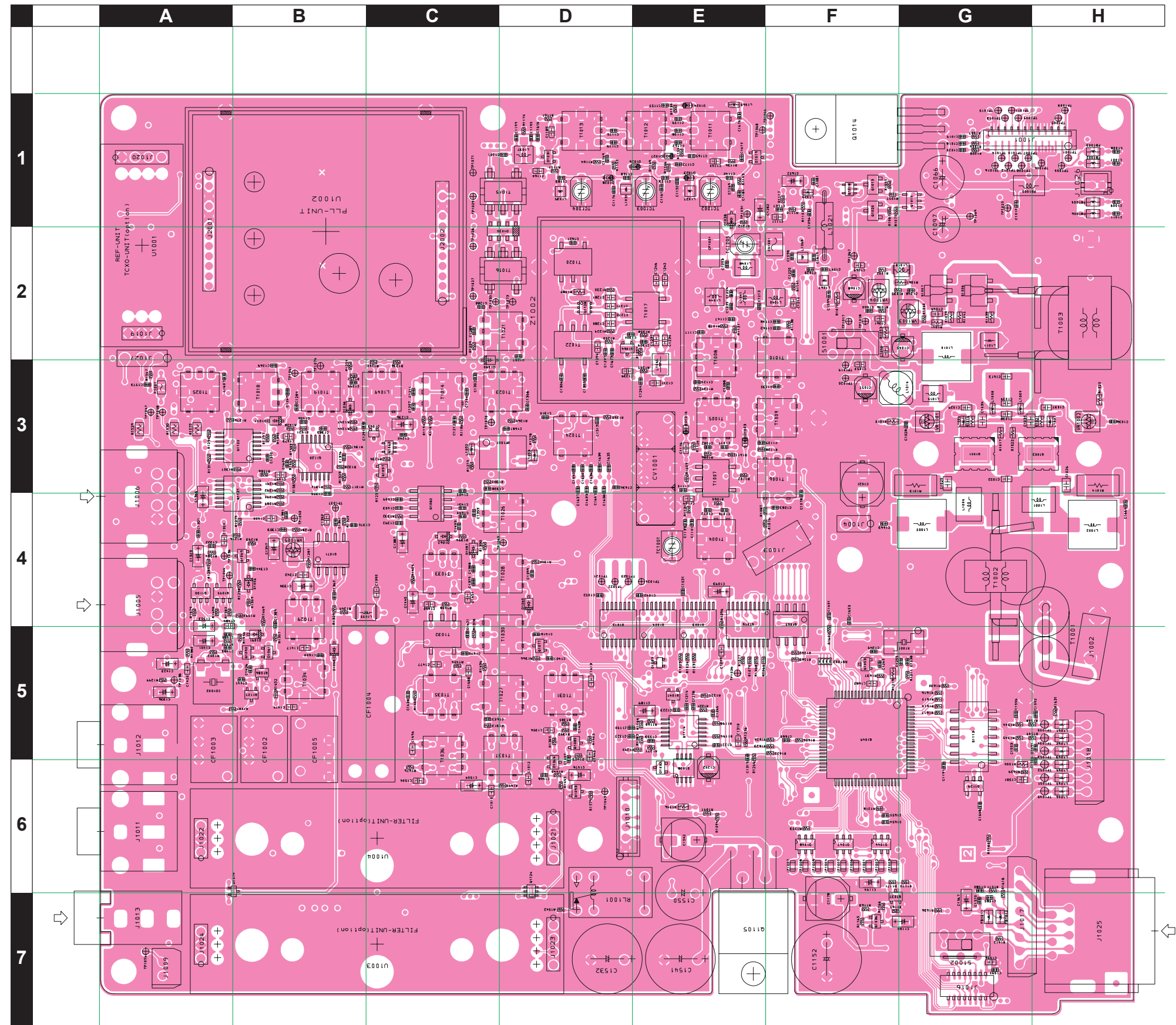
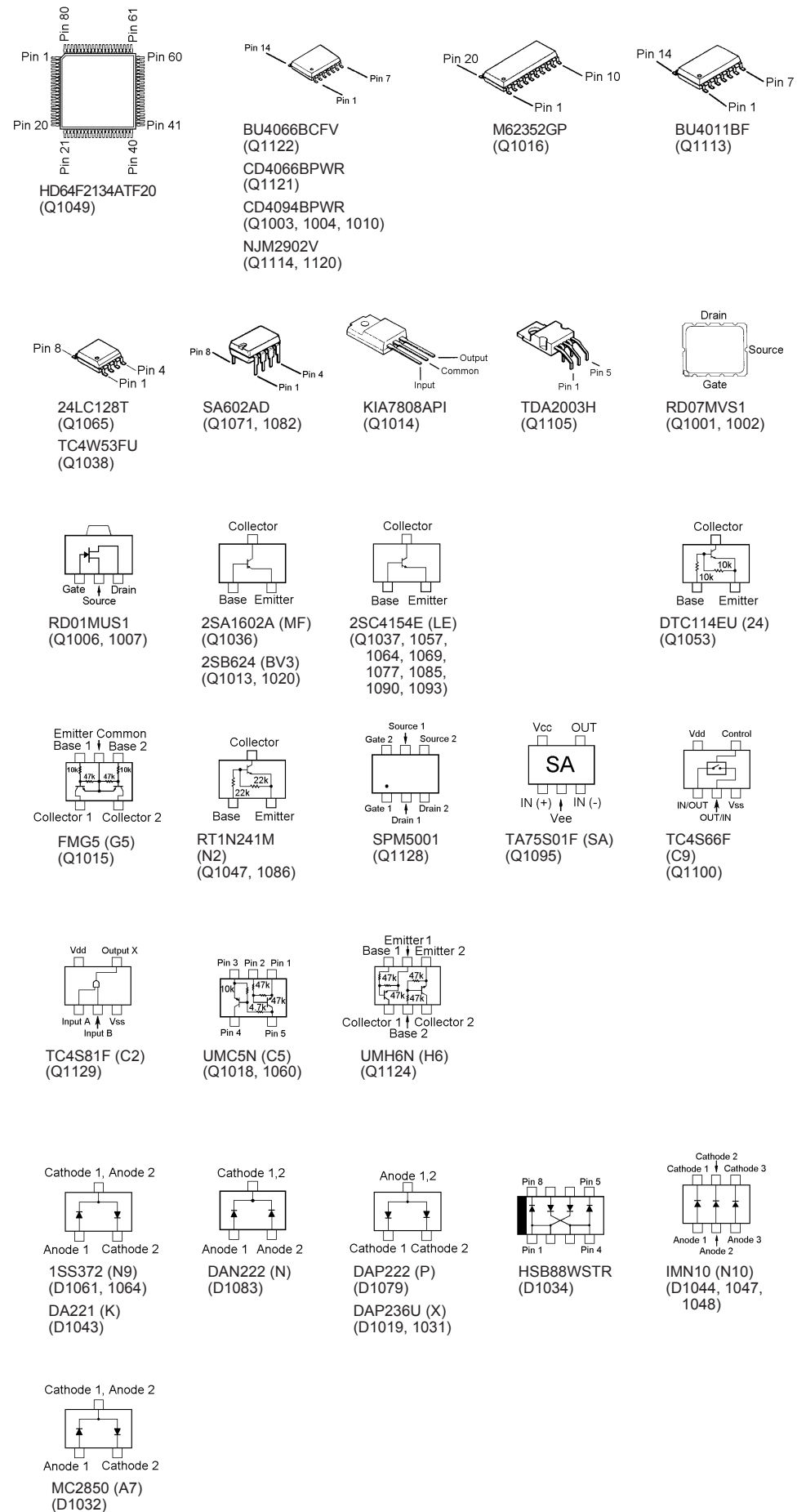

MAIN Unit (Lot 40 ~)

Parts Layout (Side B)

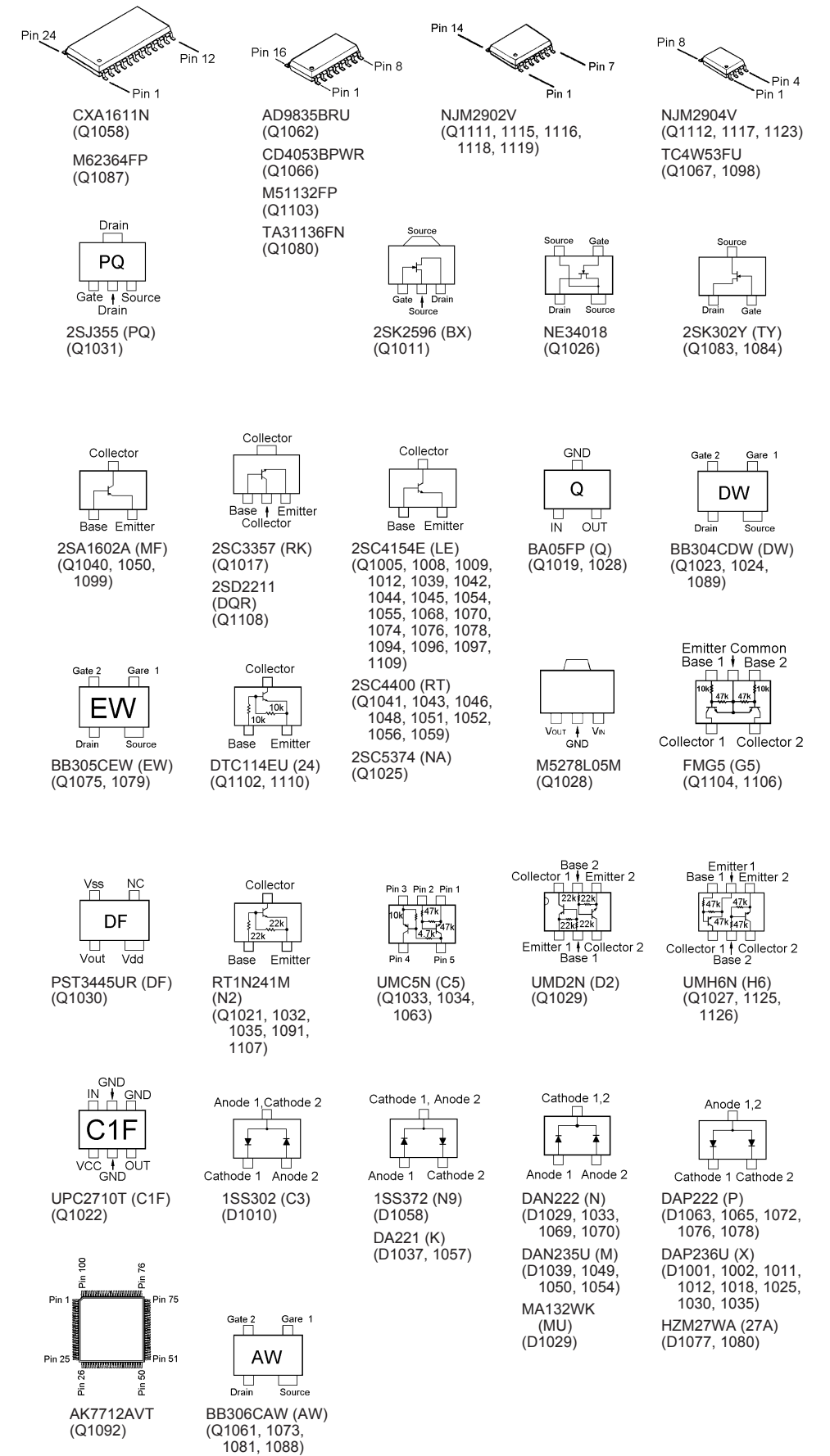
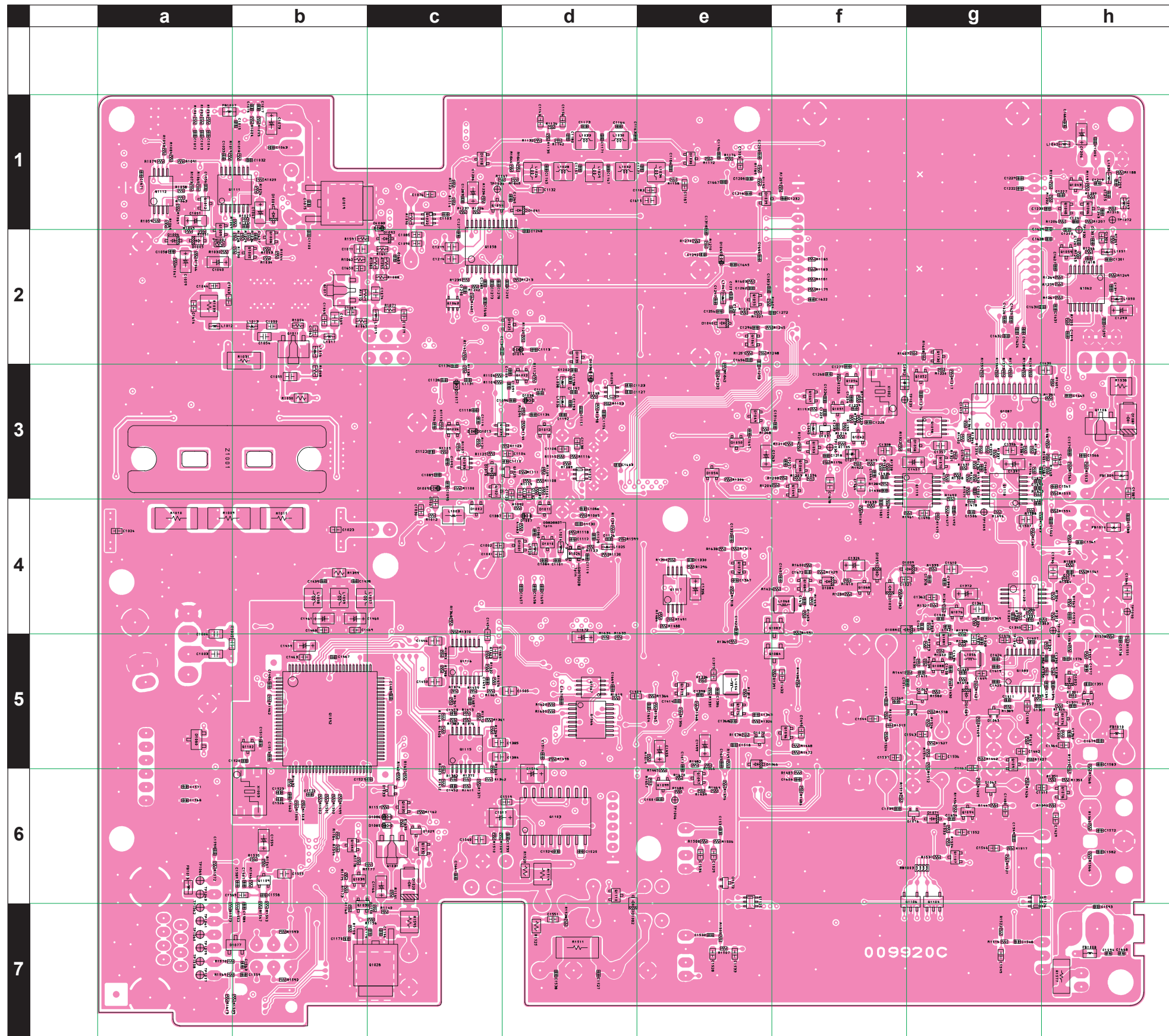

| REF | DESCRIPTION | VALUE | V/W | TOL. | MFR'S DESIG | VXSTD P/N | VERS. | LOT | SIDE | LAY ADR |
|--------|--------------------------------------------|---------|-----|------|--------------------|-----------|-----------|-------|------|---------|
| | PCB with Components (w/PLL-UNIT, REF-UNIT) | | | | FT-857 | CS1823004 | VER. A2 | | | |
| | | | | | FT-857 | CS1823005 | VER. A1 | | | |
| | | | | | FT-857 | CS1823006 | VER. A2EX | | | |
| | | | | | FT-857 | CS1823007 | VER. A3 | | | |
| | | | | | FT-857 | CS1823008 | VER. B1 | | | |
| | | | | | FT-857 | CS1823009 | VER. B2 | | | |
| | | | | | FT-857 | CS1823010 | VER. B3 | | | |
| | | | | | FT-857 | CS1823011 | VER. C1 | | | |
| | | | | | FT-857 | CS1823012 | VER. C2 | | | |
| | | | | | FT-857 | CS1823013 | VER. C3 | | | |
| | | | | | FT-857 | CS1823014 | VER. D1 | | | |
| | | | | | FT-857 | CS1823015 | VER. D2 | | | |
| | | | | | FT-857 | CS1823016 | VER. H1 | | | |
| | | | | | FT-857 | CS1823017 | VER. H1 | | | |
| | | | | | FT-857 | CS1823018 | VER. E1 | | | |
| | | | | | FT-857 | CS1823019 | VER. E2 | | | |
| | | | | | FT-857 | CS1823020 | VER. E3 | | | |
| | PCB with Components (w/PLL-UNIT) | | | | FT-857D | CS1833004 | VER. A2 | | | |
| | | | | | FT-857D | CS1833005 | VER. A1 | | | |
| | | | | | FT-857D | CS1833006 | VER. A2EX | | | |
| | | | | | FT-857D | CS1833007 | VER. A3 | | | |
| | | | | | FT-857D | CS1833008 | VER. B1 | | | |
| | | | | | FT-857D | CS1833009 | VER. B2 | | | |
| | | | | | FT-857D | CS1833010 | VER. B3 | | | |
| | | | | | FT-857D | CS1833011 | VER. C1 | | | |
| | | | | | FT-857D | CS1833012 | VER. C2 | | | |
| | | | | | FT-857D | CS1833013 | VER. C3 | | | |
| | | | | | FT-857D | CS1833014 | VER. D1 | | | |
| | | | | | FT-857D | CS1833015 | VER. D2 | | | |
| | | | | | FT-857D | CS1833016 | VER. H1 | | | |
| | | | | | FT-857D | CS1833017 | VER. H1 | | | |
| | | | | | FT-857D | CS1833018 | VER. E1 | | | |
| | | | | | FT-857D | CS1833019 | VER. E2 | | | |
| | | | | | FT-857D | CS1833020 | VER. E3 | | | |
| | Printed Circuit Board | | | | AH007M000 | FR009920A | | 1- | | |
| | | | | | AH007M000 | FR009920B | | 18-39 | | |
| | | | | | AH007M000 | FR009920C | | 40- | | |
| C 1001 | CHIP CAP. | 0.001uF | 50V | B | GRM188B11H102KA01D | K22174821 | | 1- | B | c4 |
| C 1002 | CHIP CAP. | 0.1uF | 16V | B | GRM188B11C104KA01D | K22124805 | | 1- | B | c4 |
| C 1003 | CHIP CAP. | 0.1uF | 25V | B | GRM40B104M25PT | K22140811 | | 1- | B | a5 |
| C 1004 | CHIP CAP. | 0.1uF | 25V | B | GRM40B104M25PT | K22140811 | | 1- | B | a4 |
| C 1005 | CHIP CAP. | 6pF | 50V | CH | GRM1882C1H6R0DZ01D | K22174207 | | 1- | B | a5 |
| C 1007 | CHIP CAP. | 0.001uF | 50V | B | UMK105B102KW-F | K22178829 | | 1- | A | H1 |
| C 1008 | CHIP CAP. | 0.001uF | 50V | B | UMK105B102KW-F | K22178829 | | 1- | A | H1 |
| C 1009 | CHIP CAP. | 0.001uF | 50V | B | UMK105B102KW-F | K22178829 | | 1- | A | H1 |
| C 1010 | CHIP CAP. | 0.001uF | 50V | B | UMK105B102KW-F | K22178829 | | 1- | A | G1 |
| C 1011 | CHIP CAP. | 0.001uF | 50V | B | UMK105B102KW-F | K22178829 | | 1- | A | H1 |
| C 1012 | CHIP CAP. | 100pF | 50V | CH | UMK105CH101JV-F | K22178282 | | 1- | B | a1 |
| C 1013 | CHIP CAP. | 220pF | 25V | CH | TMK105CH221JV-F | K22148246 | | 1- | B | a1 |
| C 1014 | CHIP CAP. | 100pF | 50V | CH | UMK105CH101JV-F | K22178282 | | 1- | B | a1 |
| C 1015 | CHIP CAP. | 0.001uF | 50V | B | UMK105B102KW-F | K22178829 | | 1- | B | b1 |
| C 1016 | CHIP CAP. | 0.001uF | 50V | B | UMK105B102KW-F | K22178829 | | 1- | B | b1 |
| C 1017 | CHIP CAP. | 0.001uF | 50V | B | UMK105B102KW-F | K22178829 | | 1- | B | b1 |
| C 1018 | CHIP CAP. | 0.001uF | 50V | B | UMK105B102KW-F | K22178829 | | 1- | A | G1 |
| C 1019 | CHIP CAP. | 0.001uF | 50V | B | UMK105B102KW-F | K22178829 | | 1- | A | G1 |
| C 1020 | CHIP CAP. | 0.001uF | 50V | B | UMK105B102KW-F | K22178829 | | 1- | A | G1 |
| C 1021 | AL.ELECTRO.CAP. | 47uF | 16V | | EEE1CA470SP | K48120005 | | 1- | A | F3 |
| C 1023 | CHIP CAP. | 0.1uF | 16V | B | GRM188B11C104KA01D | K22124805 | | 1- | B | b4 |
| C 1024 | CHIP CAP. | 0.1uF | 16V | B | GRM188B11C104KA01D | K22124805 | | 1- | B | a4 |
| C 1025 | CHIP CAP. | 0.1uF | 25V | B | GRM40B104M25PT | K22140811 | | 1- | A | G3 |
| C 1026 | CHIP CAP. | 0.1uF | 25V | B | GRM40B104M25PT | K22140811 | | 1- | A | H3 |
| C 1029 | CHIP CAP. | 0.1uF | 16V | B | GRM188B11C104KA01D | K22124805 | | 1- | A | G3 |
| C 1030 | CHIP CAP. | 0.1uF | 16V | B | GRM188B11C104KA01D | K22124805 | | 1- | B | c4 |
| C 1031 | CHIP CAP. | 0.01uF | 16V | B | GRM36B103K16PT | K22128804 | | 1- | A | E4 |
| C 1032 | CHIP CAP. | 0.001uF | 50V | B | UMK105B102KW-F | K22178829 | | 1- | B | b1 |
| C 1033 | CHIP CAP. | 0.001uF | 50V | B | UMK105B102KW-F | K22178829 | | 1- | B | a1 |
| C 1034 | CHIP CAP. | 0.1uF | 25V | B | GRM40B104M25PT | K22140811 | | 1- | A | G3 |
| C 1035 | CHIP CAP. | 0.1uF | 25V | B | GRM40B104M25PT | K22140811 | | 1- | A | G3 |
| C 1037 | CHIP CAP. | 0.1uF | 16V | B | GRM188B11C104KA01D | K22124805 | | 1- | A | H3 |
| C 1038 | CHIP CAP. | 12pF | 50V | CH | GRM1882C1H120JA01D | K22174213 | | 1- | A | G3 |
| C 1039 | CHIP CAP. | 22pF | 50V | CH | GRM1882C1H220JA01D | K22174219 | | 1-13 | A | G3 |
| C 1039 | CHIP CAP. | 1pF | 50V | CK | GRM1884C1H1R0CZ01D | K22174202 | | 43- | A | G3 |
| C 1040 | CHIP TA.CAP. | 1uF | 16V | | TESVA1C105M1-8R | K78120009 | | 1- | B | a2 |

MAIN Unit

Parts List

| REF | DESCRIPTION | VALUE | V/W | TOL. | MFR'S DESIG | VXSTD P/N | VERS. | LOT | SIDE | LAY ADR |
|--------|-----------------|---------|------|------|--------------------|-----------|-------|-----|------|---------|
| C 1042 | CHIP CAP. | 0.01uF | 16V | B | GRM36B103K16PT | K22128804 | | 1- | A | E4 |
| C 1043 | CHIP CAP. | 10pF | 50V | CH | GRM1882C1H100JA01D | K22174211 | | 1- | B | a2 |
| C 1044 | CHIP CAP. | 0.01uF | 50V | B | GRM188B11H103KA01D | K22174823 | | 1- | B | a2 |
| C 1045 | AL.ELECTRO.CAP. | 10uF | 16V | | RV2-16V100MB55U-R | K48120014 | | 1- | A | G2 |
| C 1046 | CHIP CAP. | 0.1uF | 16V | B | GRM188B11C104KA01D | K22124805 | | 1- | A | F2 |
| C 1047 | CHIP TA.CAP. | 4.7uF | 10V | | TEMSVA1A475M-8R | K78100022 | | 1- | B | b1 |
| C 1047 | CHIP TA.CAP. | 0.22uF | 35V | | TESVA1V224M1-8R | K78160027 | | 79- | B | b1 |
| C 1049 | CHIP CAP. | 0.1uF | 16V | B | GRM188B11C104KA01D | K22124805 | | 1- | A | G2 |
| C 1050 | CHIP CAP. | 8pF | 50V | CH | GRM1882C1H8R0DZ01D | K22174209 | | 1- | B | b2 |
| C 1051 | CHIP TA.CAP. | 1uF | 16V | | TESVA1C105M1-8R | K78120009 | | 1- | B | a1 |
| C 1052 | CHIP CAP. | 0.01uF | 16V | B | GRM36B103K16PT | K22128804 | | 1- | A | D4 |
| C 1053 | CHIP CAP. | 0.1uF | 16V | B | GRM188B11C104KA01D | K22124805 | | 1- | A | F3 |
| C 1054 | CHIP CAP. | 0.1uF | 25V | B | GRM40B104M25PT | K22140811 | | 1- | B | b2 |
| C 1055 | CHIP CAP. | 0.1uF | 25V | B | GRM40B104M25PT | K22140811 | | 1- | B | b3 |
| C 1056 | CHIP CAP. | 0.1uF | 10V | B | GRM155B11A104KA01D | K22108802 | | 1- | B | a1 |
| C 1057 | AL.ELECTRO.CAP. | 10uF | 16V | | RV2-16V100MB55U-R | K48120014 | | 1- | A | F3 |
| C 1058 | CHIP CAP. | 0.01uF | 16V | B | GRM36B103K16PT | K22128804 | | 1- | B | a2 |
| C 1059 | CHIP TA.CAP. | 10uF | 10V | | TEMSVA1A106M-8R | K78100028 | | 1- | B | a2 |
| C 1061 | CHIP CAP. | 0.1uF | 16V | B | GRM188B11C104KA01D | K22124805 | | 1- | A | F2 |
| C 1063 | CHIP CAP. | 0.01uF | 16V | B | GRM36B103K16PT | K22128804 | | 1- | B | b1 |
| C 1064 | CHIP CAP. | 0.1uF | 25V | B | GRM40B104M25PT | K22140811 | | 1- | B | b2 |
| C 1065 | CHIP CAP. | 10pF | 50V | CH | GRM1882C1H100JA01D | K22174211 | | 1- | B | b2 |
| C 1066 | AL.ELECTRO.CAP. | 100uF | 16V | | RC2-16V101MF1# | K40129038 | | 1- | A | G1 |
| C 1067 | CHIP CAP. | 0.01uF | 50V | B | GRM188B11H103KA01D | K22174823 | | 1- | B | b2 |
| C 1068 | AL.ELECTRO.CAP. | 10uF | 16V | | RV2-16V100MB55U-R | K48120014 | | 1- | A | F2 |
| C 1069 | CHIP CAP. | 0.1uF | 16V | B | GRM188B11C104KA01D | K22124805 | | 1- | A | F2 |
| C 1070 | CHIP CAP. | 120pF | 50V | CH | UMK105CH121JV-F | K22178284 | | 1- | A | E4 |
| C 1071 | CHIP CAP. | 0.1uF | 25V | B | GRM40B104M25PT | K22140811 | | 1- | B | b2 |
| C 1072 | CHIP CAP. | 150pF | 25V | CH | TMK105CH151JV-F | K22148242 | | 1- | A | E4 |
| C 1073 | CHIP TA.CAP. | 0.47uF | 25V | | TESVA1E474M1-8R | K78140009 | | 1- | B | b1 |
| C 1074 | CHIP CAP. | 0.1uF | 25V | B | GRM40B104M25PT | K22140811 | | 1- | B | c2 |
| C 1075 | CHIP CAP. | 0.01uF | 16V | B | GRM36B103K16PT | K22128804 | | 1- | B | b1 |
| C 1076 | CHIP CAP. | 0.1uF | 16V | B | GRM188B11C104KA01D | K22124805 | | 1- | B | c1 |
| C 1079 | CHIP CAP. | 0.1uF | 16V | B | GRM188B11C104KA01D | K22124805 | | 1- | B | c2 |
| C 1080 | CHIP CAP. | 7pF | 50V | CH | UMK105CH070DV-F | K22178255 | | 1- | B | d4 |
| C 1081 | CHIP CAP. | 0.001uF | 50V | B | UMK105B102KW-F | K22178829 | | 1- | A | F1 |
| C 1082 | CHIP CAP. | 0.001uF | 50V | B | UMK105B102KW-F | K22178829 | | 1- | A | E3 |
| C 1083 | CHIP CAP. | 0.001uF | 50V | B | UMK105B102KW-F | K22178829 | | 1- | A | F4 |
| C 1084 | CHIP CAP. | 22pF | 50V | CH | UMK105CH220JV-F | K22178266 | | 1- | B | d4 |
| C 1085 | CHIP CAP. | 0.001uF | 50V | B | GRM188B11H102KA01D | K22174821 | | 1- | B | c2 |
| C 1086 | CHIP CAP. | 0.001uF | 50V | B | UMK105B102KW-F | K22178829 | | 1- | B | d4 |
| C 1087 | CHIP CAP. | 0.1uF | 16V | B | GRM188B11C104KA01D | K22124805 | | 1- | B | d4 |
| C 1088 | CHIP CAP. | 2pF | 50V | CK | UMK105CK020CV-F | K22178250 | | 1- | A | E3 |
| C 1090 | CHIP CAP. | 0.1uF | 16V | B | GRM188B11C104KA01D | K22124805 | | 1- | B | c2 |
| C 1090 | CHIP CAP. | 0.001uF | 50V | B | GRM188B11H102KA01D | K22174821 | | 79- | B | c2 |
| C 1091 | CHIP CAP. | 47pF | 50V | CH | UMK105CH470JV-F | K22178274 | | 1- | B | d3 |
| C 1092 | CHIP CAP. | 15pF | 50V | CH | UMK105CH150JV-F | K22178262 | | 1- | B | c3 |
| C 1093 | CHIP TA.CAP. | 10uF | 10V | | TEMSVA1A106M-8R | K78100028 | | 1- | A | E4 |
| C 1094 | CHIP CAP. | 470pF | 50V | B | UMK105B471KW-F | K22178825 | | 1- | B | d3 |
| C 1095 | CHIP CAP. | 33pF | 50V | CH | UMK105CH330JV-F | K22178270 | | 1- | B | c3 |
| C 1096 | CHIP CAP. | 0.01uF | 16V | B | GRM36B103K16PT | K22128804 | | 1- | A | F1 |
| C 1097 | AL.ELECTRO.CAP. | 100uF | 6.3V | | RC2-6V101ME1#-T58 | K46080006 | | 1- | A | G2 |
| C 1099 | CHIP CAP. | 0.1uF | 16V | B | GRM188B11C104KA01D | K22124805 | | 1- | A | E5 |
| C 1100 | CHIP CAP. | 100pF | 50V | CH | UMK105CH101JV-F | K22178282 | | 1- | B | b2 |
| C 1101 | CHIP CAP. | 6pF | 50V | CH | UMK105CH060DV-F | K22178254 | | 1- | B | d4 |
| C 1101 | CHIP CAP. | 7pF | 50V | CH | UMK105CH070DV-F | K22178255 | | 57- | B | d4 |
| C 1102 | CHIP CAP. | 0.1uF | 16V | B | GRM188B11C104KA01D | K22124805 | | 1- | B | d3 |
| C 1103 | CHIP CAP. | 0.047uF | 10V | BJ | LMK105BJ473KV-F | K22108805 | | 1- | B | c1 |
| C 1103 | CHIP CAP. | 0.01uF | 25V | B | GRM155B11E103KA01D | K22148834 | | 79- | B | c1 |
| C 1104 | CHIP CAP. | 0.1uF | 16V | B | GRM188B11C104KA01D | K22124805 | | 1- | B | d3 |
| C 1105 | CHIP CAP. | 0.001uF | 50V | B | UMK105B102KW-F | K22178829 | | 1- | B | d3 |
| C 1106 | CHIP CAP. | 0.001uF | 50V | B | UMK105B102KW-F | K22178829 | | 1- | B | c3 |
| C 1107 | CHIP CAP. | 0.001uF | 50V | B | UMK105B102KW-F | K22178829 | | 1- | A | F1 |
| C 1108 | CHIP CAP. | 0.1uF | 16V | B | GRM188B11C104KA01D | K22124805 | | 1- | B | d3 |
| C 1109 | CHIP CAP. | 0.1uF | 16V | B | GRM188B11C104KA01D | K22124805 | | 1- | A | E4 |
| C 1110 | CHIP CAP. | 0.001uF | 50V | B | UMK105B102KW-F | K22178829 | | 1- | B | d3 |
| C 1111 | CHIP CAP. | 0.1uF | 16V | B | GRM188B11C104KA01D | K22124805 | | 1- | A | F1 |
| C 1112 | CHIP CAP. | 0.001uF | 50V | B | UMK105B102KW-F | K22178829 | | 1- | B | d4 |
| C 1113 | CHIP CAP. | 470pF | 50V | B | UMK105B471KW-F | K22178825 | | 1- | B | d2 |
| C 1114 | CHIP CAP. | 33pF | 50V | CH | UMK105CH330JV-F | K22178270 | | 1- | B | c3 |
| C 1115 | CHIP CAP. | 0.001uF | 50V | B | UMK105B102KW-F | K22178829 | | 1- | A | E3 |
| C 1116 | CHIP CAP. | 0.1uF | 16V | B | GRM188B11C104KA01D | K22124805 | | 1- | A | E3 |
| C 1117 | CHIP CAP. | 5pF | 50V | CH | UMK105CH050CV-F | K22178253 | | 1- | A | E2 |

MAIN Unit

Parts List

| REF | DESCRIPTION | VALUE | V/W | TOL. | MFR'S DESIG | VXSTD P/N | | LOT | SIDE | LAY ADR |
|--------|-----------------|---------|------|------|--------------------|-----------|--------|------|------|---------|
| C 1118 | CHIP CAP. | 2pF | 50V | CK | UMK105CK020CV-F | K22178250 | | 1- | B | c3 |
| C 1119 | CHIP CAP. | 0.001uF | 50V | B | UMK105B102KW-F | K22178829 | | 1- | B | d4 |
| C 1120 | CHIP CAP. | 0.1uF | 16V | B | GRM188B11C104KA01D | K22124805 | | 1- | B | d3 |
| C 1121 | CHIP CAP. | 0.01uF | 16V | B | GRM36B103K16PT | K22128804 | | 1- | B | d3 |
| C 1122 | CHIP CAP. | 0.01uF | 16V | B | GRM36B103K16PT | K22128804 | | 1- | B | c3 |
| C 1123 | CHIP CAP. | 0.001uF | 50V | B | UMK105B102KW-F | K22178829 | | 1- | B | d3 |
| C 1124 | CHIP CAP. | 0.001uF | 50V | B | UMK105B102KW-F | K22178829 | | 1- | A | E3 |
| C 1125 | CHIP CAP. | 0.001uF | 50V | B | UMK105B102KW-F | K22178829 | | 1- | A | E3 |
| C 1126 | CHIP CAP. | 0.001uF | 50V | B | UMK105B102KW-F | K22178829 | | 1- | B | d4 |
| C 1127 | CHIP CAP. | 0.01uF | 16V | B | GRM36B103K16PT | K22128804 | | 1- | B | d3 |
| C 1128 | CHIP CAP. | 7pF | 50V | CH | UMK105CH070DV-F | K22178255 | | 1- | B | c3 |
| C 1129 | CHIP CAP. | 4pF | 50V | CH | UMK105CH040CV-F | K22178252 | | 1- | B | d4 |
| C 1131 | CHIP CAP. | 33pF | 50V | CH | UMK105CH330JV-F | K22178270 | | 1- | B | c3 |
| C 1132 | CHIP CAP. | 0.1uF | 16V | B | GRM188B11C104KA01D | K22124805 | | 1- | B | d1 |
| C 1133 | CHIP CAP. | 0.01uF | 16V | B | GRM36B103K16PT | K22128804 | | 1- | A | E4 |
| C 1134 | CHIP CAP. | 0.001uF | 50V | B | UMK105B102KW-F | K22178829 | | 1- | B | d3 |
| C 1136 | CHIP CAP. | 0.001uF | 50V | B | UMK105B102KW-F | K22178829 | | 1- | B | c3 |
| C 1137 | CHIP CAP. | 47pF | 50V | CH | UMK105CH470JV-F | K22178274 | | 1- | B | c2 |
| C 1138 | CHIP CAP. | 0.1uF | 16V | B | GRM188B11C104KA01D | K22124805 | | 1- | B | d3 |
| C 1139 | CHIP CAP. | 0.1uF | 16V | B | GRM188B11C104KA01D | K22124805 | | 1- | B | d3 |
| C 1140 | CHIP CAP. | 2pF | 50V | CK | UMK105CK020CV-F | K22178250 | | 1- | A | E1 |
| C 1141 | CHIP CAP. | 0.001uF | 50V | B | UMK105B102KW-F | K22178829 | | 1- | A | E4 |
| C 1142 | CHIP CAP. | 0.001uF | 50V | B | UMK105B102KW-F | K22178829 | | 1- | A | F2 |
| C 1143 | CHIP CAP. | 0.1uF | 16V | B | GRM188B11C104KA01D | K22124805 | | 1- | B | d1 |
| C 1144 | CHIP CAP. | 0.1uF | 16V | B | GRM188B11C104KA01D | K22124805 | | 1- | A | E1 |
| C 1145 | CHIP CAP. | 100pF | 50V | CH | UMK105CH101JV-F | K22178282 | | 1- | B | d1 |
| C 1146 | CHIP CAP. | 0.01uF | 16V | B | GRM36B103K16PT | K22128804 | | 1- | B | c7 |
| C 1147 | CHIP CAP. | 0.001uF | 50V | B | UMK105B102KW-F | K22178829 | | 1- | A | E2 |
| C 1148 | CHIP CAP. | 0.001uF | 50V | B | UMK105B102KW-F | K22178829 | | 1- | A | F2 |
| C 1150 | CHIP CAP. | 6pF | 50V | CH | UMK105CH060DV-F | K22178254 | | 1- | A | E1 |
| C 1151 | CHIP CAP. | 100pF | 50V | CH | UMK105CH101JV-F | K22178282 | | 1- | B | d3 |
| C 1152 | AL.ELECTRO.CAP. | 1000uF | 16V | | RE3-16V102MH3# | K40129096 | | 1- | A | F7 |
| C 1153 | CHIP CAP. | 1pF | 50V | CK | UMK105CK010CV-F | K22178248 | | 1- | A | E1 |
| C 1154 | CHIP CAP. | 0.01uF | 16V | B | GRM36B103K16PT | K22128804 | | 1- | B | d3 |
| C 1155 | CHIP CAP. | 33pF | 50V | CH | UMK105CH330JV-F | K22178270 | | 1- | A | E1 |
| C 1156 | CHIP CAP. | 0.1uF | 16V | B | GRM188B11C104KA01D | K22124805 | | 1- | B | d1 |
| C 1157 | CHIP CAP. | 27pF | 50V | CH | UMK105CH270JV-F | K22178268 | | 1- | B | d1 |
| C 1158 | CHIP CAP. | 2pF | 50V | CK | UMK105CK020CV-F | K22178250 | | 1- | A | E1 |
| C 1159 | CHIP CAP. | 3pF | 50V | CJ | UMK105CJ030CV-F | K22178251 | | 1-2 | A | E1 |
| C 1159 | CHIP CAP. | 1pF | 50V | CK | UMK105CK010CV-F | K22178248 | W/ CE | 3-17 | A | E1 |
| C 1159 | CHIP CAP. | 3pF | 50V | CJ | UMK105CJ030CV-F | K22178251 | W/O CE | 3-17 | A | E1 |
| C 1159 | CHIP CAP. | 1pF | 50V | CK | UMK105CK010CV-F | K22178248 | | 18- | A | E1 |
| C 1160 | CHIP CAP. | 0.1uF | 16V | B | GRM188B11C104KA01D | K22124805 | | 1- | A | D1 |
| C 1161 | CHIP CAP. | 5pF | 50V | CH | UMK105CH050CV-F | K22178253 | | 1- | A | E1 |
| C 1161 | CHIP CAP. | 6pF | 50V | CH | UMK105CH060DV-F | K22178254 | | 29- | A | E1 |
| C 1162 | CHIP CAP. | 3pF | 50V | CJ | UMK105CJ030CV-F | K22178251 | | 1- | A | E1 |
| C 1163 | CHIP CAP. | 100pF | 50V | CH | UMK105CH101JV-F | K22178282 | | 1- | B | d1 |
| C 1163 | CHIP CAP. | 180pF | 25V | CH | TMK105CH181JV-F | K22148244 | | 7- | B | d1 |
| C 1163 | CHIP CAP. | 100pF | 50V | CH | UMK105CH101JV-F | K22178282 | | 79- | B | d1 |
| C 1164 | CHIP CAP. | 9pF | 50V | CH | UMK105CH090DV-F | K22178257 | | 1- | B | d1 |
| C 1164 | CHIP CAP. | 15pF | 50V | CH | UMK105CH150JV-F | K22178262 | | 7- | B | d1 |
| C 1164 | CHIP CAP. | 7pF | 50V | CH | UMK105CH070DV-F | K22178255 | | 79- | B | d1 |
| C 1165 | CHIP CAP. | 33pF | 50V | CH | UMK105CH330JV-F | K22178270 | | 1- | A | E1 |
| C 1166 | CHIP TA.CAP. | 1uF | 16V | | TESVA1C105M1-8R | K78120009 | | 1- | B | c6 |
| C 1167 | CHIP CAP. | 220pF | 25V | CH | TMK105CH221JV-F | K22148246 | | 1- | B | d1 |
| C 1168 | CHIP CAP. | 0.5pF | 50V | CK | UMK105CK0R5CV-F | K22178247 | | 1- | A | D1 |
| C 1169 | CHIP CAP. | 0.001uF | 50V | B | UMK105B102KW-F | K22178829 | | 1- | A | D1 |
| C 1170 | CHIP CAP. | 0.001uF | 50V | B | UMK105B102KW-F | K22178829 | | 1- | B | b7 |
| C 1171 | CHIP CAP. | 150pF | 25V | CH | TMK105CH151JV-F | K22148242 | | 1- | B | d1 |
| C 1171 | CHIP CAP. | 270pF | 25V | CH | GRM36CH271J25PT | K22148248 | | 7- | B | d1 |
| C 1171 | CHIP CAP. | 270pF | 50V | B | UMK105B271KW-F | K22178822 | | 18- | B | d1 |
| C 1171 | CHIP CAP. | 220pF | 25V | CH | TMK105CH221JV-F | K22148246 | | 79- | B | d1 |
| C 1172 | CHIP CAP. | 0.001uF | 50V | B | UMK105B102KW-F | K22178829 | | 1- | A | E1 |
| C 1173 | CHIP CAP. | 27pF | 50V | CH | UMK105CH270JV-F | K22178268 | | 1- | B | d1 |
| C 1173 | CHIP CAP. | 39pF | 50V | CH | UMK105CH390JV-F | K22178272 | | 7- | B | d1 |
| C 1173 | CHIP CAP. | 15pF | 50V | CH | UMK105CH150JV-F | K22178262 | | 79- | B | d1 |
| C 1174 | CHIP CAP. | 0.01uF | 16V | B | GRM36B103K16PT | K22128804 | | 1- | B | c7 |
| C 1175 | CHIP CAP. | 10pF | 50V | CH | UMK105CH100DV-F | K22178258 | | 1- | A | D1 |
| C 1176 | CHIP CAP. | 4pF | 50V | CH | UMK105CH040CV-F | K22178252 | | 1- | A | D1 |
| C 1176 | CHIP CAP. | 6pF | 50V | CH | UMK105CH060DV-F | K22178254 | | 29- | A | D1 |
| C 1177 | CHIP CAP. | 27pF | 50V | CH | UMK105CH270JV-F | K22178268 | | 1- | B | e1 |
| C 1178 | AL.ELECTRO.CAP. | 100uF | 6.3V | | RV2-6V101MU-R | K48080005 | | 1- | A | F7 |
| C 1179 | CHIP CAP. | 10pF | 50V | CH | UMK105CH100DV-F | K22178258 | | 1- | A | D1 |

MAIN Unit

Parts List

| REF | DESCRIPTION | VALUE | V/W | TOL. | MFR'S DESIG | VXSTD P/N | VERS. | LOT | SIDE | LAY ADR |
|--------|--------------|----------|-----|------|--------------------|-----------|-------|-----|------|---------|
| C 1180 | CHIP CAP. | 68pF | 50V | CH | UMK105CH680JV-F | K22178278 | | 1- | B | d1 |
| C 1180 | CHIP CAP. | 120pF | 50V | CH | UMK105CH121JV-F | K22178284 | | 7- | B | d1 |
| C 1182 | CHIP CAP. | 0.1uF | 16V | B | GRM188B11C104KA01D | K22124805 | | 1- | B | e1 |
| C 1183 | CHIP CAP. | 2pF | 50V | CK | UMK105CK020CV-F | K22178250 | | 1- | A | D1 |
| C 1184 | CHIP CAP. | 0.001uF | 50V | B | UMK105B102KW-F | K22178829 | | 1- | A | E1 |
| C 1184 | CHIP CAP. | 0.01uF | 16V | B | GRM36B103K16PT | K22128804 | | 4- | A | E1 |
| C 1185 | CHIP CAP. | 0.1uF | 16V | B | GRM188B11C104KA01D | K22124805 | | 1- | A | D1 |
| C 1186 | CHIP CAP. | 120pF | 50V | CH | UMK105CH121JV-F | K22178284 | | 1- | B | e1 |
| C 1187 | CHIP CAP. | 0.1uF | 16V | B | GRM188B11C104KA01D | K22124805 | | 1- | B | e1 |
| C 1188 | CHIP TA.CAP. | 1uF | 16V | | TESVA1C105M1-8R | K78120009 | | 1- | A | G7 |
| C 1189 | CHIP TA.CAP. | 1uF | 16V | | TESVA1C105M1-8R | K78120009 | | 1- | A | E5 |
| C 1190 | CHIP CAP. | 0.01uF | 16V | B | GRM36B103K16PT | K22128804 | | 1- | A | D5 |
| C 1191 | CHIP CAP. | 0.01uF | 16V | B | GRM36B103K16PT | K22128804 | | 1- | A | G6 |
| C 1192 | CHIP CAP. | 33pF | 50V | CH | UMK105CH330JV-F | K22178270 | | 1- | B | d3 |
| C 1193 | CHIP CAP. | 27pF | 50V | CH | UMK105CH270JV-F | K22178268 | | 1- | B | d3 |
| C 1194 | CHIP TA.CAP. | 1uF | 16V | | TESVA1C105M1-8R | K78120009 | | 1- | A | F6 |
| C 1195 | CHIP CAP. | 120pF | 50V | CH | UMK105CH121JV-F | K22178284 | | 1- | A | D1 |
| C 1196 | CHIP CAP. | 0.001uF | 50V | B | UMK105B102KW-F | K22178829 | | 1- | B | e1 |
| C 1197 | CHIP CAP. | 100pF | 50V | CH | UMK105CH101JV-F | K22178282 | | 1- | B | d3 |
| C 1198 | CHIP CAP. | 9pF | 50V | CH | UMK105CH090DV-F | K22178257 | | 1- | B | d3 |
| C 1199 | CHIP CAP. | 120pF | 50V | CH | UMK105CH121JV-F | K22178284 | | 1- | A | D1 |
| C 1200 | CHIP CAP. | 0.001uF | 50V | B | UMK105B102KW-F | K22178829 | | 1- | B | e1 |
| C 1201 | CHIP CAP. | 0.01uF | 16V | B | GRM36B103K16PT | K22128804 | | 1- | A | D1 |
| C 1201 | CHIP CAP. | 0.0022uF | 50V | B | UMK105B222KW-F | K22178833 | | 79- | A | D1 |
| C 1202 | CHIP CAP. | 68pF | 50V | CH | UMK105CH680JV-F | K22178278 | | 1- | B | d3 |
| C 1203 | CHIP CAP. | 0.1uF | 16V | B | GRM188B11C104KA01D | K22124805 | | 1- | B | e1 |
| C 1204 | CHIP CAP. | 12pF | 50V | CH | UMK105CH120JV-F | K22178260 | | 1- | A | C3 |
| C 1204 | CHIP CAP. | 5pF | 50V | CH | UMK105CH050CV-F | K22178253 | | 79- | A | C3 |
| C 1205 | CHIP CAP. | 0.01uF | 16V | B | GRM36B103K16PT | K22128804 | | 1- | B | h1 |
| C 1206 | CHIP TA.CAP. | 10uF | 10V | | TEMSVA1A106M-8R | K78100028 | | 1- | B | h1 |
| C 1207 | CHIP CAP. | 0.01uF | 16V | B | GRM36B103K16PT | K22128804 | | 1- | A | C3 |
| C 1208 | CHIP CAP. | 0.001uF | 50V | B | UMK105B102KW-F | K22178829 | | 1- | B | e1 |
| C 1209 | CHIP CAP. | 18pF | 50V | CH | UMK105CH180JV-F | K22178264 | | 1- | B | h1 |
| C 1210 | CHIP CAP. | 0.1uF | 16V | B | GRM188B11C104KA01D | K22124805 | | 1- | A | F2 |
| C 1211 | CHIP CAP. | 18pF | 50V | CH | UMK105CH180JV-F | K22178264 | | 1- | A | C3 |
| C 1212 | CHIP CAP. | 0.01uF | 16V | B | GRM36B103K16PT | K22128804 | | 1- | A | C3 |
| C 1213 | CHIP CAP. | 100pF | 50V | CH | UMK105CH101JV-F | K22178282 | | 1- | A | E2 |
| C 1214 | CHIP CAP. | 0.001uF | 50V | B | UMK105B102KW-F | K22178829 | | 1- | A | E5 |
| C 1215 | CHIP CAP. | 15pF | 50V | CH | UMK105CH150JV-F | K22178262 | | 1- | B | h1 |
| C 1216 | CHIP CAP. | 0.001uF | 50V | B | UMK105B102KW-F | K22178829 | | 1- | B | e1 |
| C 1217 | CHIP TA.CAP. | 1uF | 10V | | TESVSP1A105M-8R | K78100032 | | 1- | B | f3 |
| C 1218 | CHIP CAP. | 0.01uF | 16V | B | GRM36B103K16PT | K22128804 | | 1- | B | f3 |
| C 1219 | CHIP CAP. | 22pF | 50V | CH | UMK105CH220JV-F | K22178266 | | 1- | B | h1 |
| C 1221 | CHIP CAP. | 0.022uF | 16V | B | EMK105B223KW-F | K22128813 | | 1- | A | E5 |
| C 1222 | CHIP CAP. | 0.001uF | 50V | B | UMK105B102KW-F | K22178829 | | 1- | B | g1 |
| C 1223 | CHIP CAP. | 0.0033uF | 50V | B | UMK105B332KW-F | K22178835 | | 1- | A | E5 |
| C 1224 | CHIP CAP. | 9pF | 50V | CH | UMK105CH090DV-F | K22178257 | | 1- | A | E2 |
| C 1225 | CHIP CAP. | 27pF | 50V | CH | UMK105CH270JV-F | K22178268 | | 1- | B | f3 |
| C 1226 | CHIP CAP. | 100pF | 50V | CH | UMK105CH101JV-F | K22178282 | | 1- | B | f3 |
| C 1227 | CHIP CAP. | 0.01uF | 16V | B | GRM36B103K16PT | K22128804 | | 1- | B | h1 |
| C 1228 | CHIP CAP. | 0.01uF | 16V | B | GRM36B103K16PT | K22128804 | | 1- | B | f3 |
| C 1229 | CHIP CAP. | 0.001uF | 50V | B | UMK105B102KW-F | K22178829 | | 1- | B | g1 |
| C 1230 | CHIP CAP. | 0.001uF | 50V | B | UMK105B102KW-F | K22178829 | | 1- | B | h1 |
| C 1232 | CHIP CAP. | 0.001uF | 50V | B | UMK105B102KW-F | K22178829 | | 1- | B | f1 |
| C 1234 | CHIP CAP. | 0.001uF | 50V | B | GRM188B11H102KA01D | K22174821 | | 1- | A | E2 |
| C 1235 | CHIP CAP. | 100pF | 50V | CH | UMK105CH101JV-F | K22178282 | | 1- | A | E2 |
| C 1236 | CHIP TA.CAP. | 10uF | 10V | | TEMSVA1A106M-8R | K78100028 | | 1- | A | C3 |
| C 1237 | CHIP CAP. | 0.1uF | 16V | B | GRM188B11C104KA01D | K22124805 | | 1- | A | E2 |
| C 1238 | CHIP CAP. | 27pF | 50V | CH | UMK105CH270JV-F | K22178268 | | 1- | A | G5 |
| C 1238 | CHIP CAP. | 10pF | 50V | CH | UMK105CH100DV-F | K22178258 | | 50- | A | G5 |
| C 1239 | CHIP CAP. | 0.1uF | 16V | B | GRM188B11C104KA01D | K22124805 | | 1- | A | D3 |
| C 1240 | CHIP CAP. | 0.01uF | 16V | B | GRM36B103K16PT | K22128804 | | 1- | A | C3 |
| C 1241 | CHIP CAP. | 10pF | 50V | CH | UMK105CH100DV-F | K22178258 | | 1- | B | h1 |
| C 1242 | CHIP CAP. | 0.001uF | 50V | B | GRM188B11H102KA01D | K22174821 | | 1- | A | E2 |
| C 1243 | CHIP CAP. | 0.01uF | 16V | B | GRM36B103K16PT | K22128804 | | 1- | B | h1 |
| C 1244 | CHIP CAP. | 0.01uF | 16V | B | GRM36B103K16PT | K22128804 | | 1- | A | E3 |
| C 1245 | CHIP CAP. | 100pF | 50V | CH | UMK105CH101JV-F | K22178282 | | 1- | B | d2 |
| C 1246 | CHIP CAP. | 0.1uF | 16V | B | GRM188B11C104KA01D | K22124805 | | 1- | A | E2 |
| C 1247 | CHIP CAP. | 4pF | 50V | CH | UMK105CH040CV-F | K22178252 | | 1- | B | e2 |
| C 1248 | CHIP CAP. | 0.01uF | 16V | B | GRM36B103K16PT | K22128804 | | 1- | B | d2 |
| C 1249 | CHIP CAP. | 47pF | 50V | CH | UMK105CH470JV-F | K22178274 | | 1- | A | F5 |
| C 1249 | CHIP CAP. | 12pF | 50V | CH | UMK105CH120JV-F | K22178260 | | 50- | A | F5 |
| C 1250 | CHIP CAP. | 0.001uF | 50V | B | UMK105B102KW-F | K22178829 | | 1- | B | h1 |

| REF | DESCRIPTION | VALUE | V/W | TOL. | MFR'S DESIG | VXSTD P/N | VERS. | LOT | SIDE | LAY ADR |
|--------|-----------------|----------|------|------|--------------------|-----------|-------|-----|------|---------|
| C 1251 | CHIP CAP. | 9pF | 50V | CH | UMK105CH090DV-F | K22178257 | | 1- | B | e2 |
| C 1252 | AL.ELECTRO.CAP. | 10uF | 16V | | RV2-16V100MB55U-R | K48120014 | | 1- | A | E6 |
| C 1253 | CHIP CAP. | 0.001uF | 50V | B | UMK105B102KW-F | K22178829 | | 1- | A | E2 |
| C 1254 | CHIP CAP. | 0.001uF | 50V | B | UMK105B102KW-F | K22178829 | | 1- | B | f3 |
| C 1255 | CHIP CAP. | 10pF | 50V | CH | UMK105CH100DV-F | K22178258 | | 1- | A | G5 |
| C 1255 | CHIP CAP. | 8pF | 50V | CH | UMK105CH080DV-F | K22178256 | | 50- | A | G5 |
| C 1256 | CHIP CAP. | 7pF | 50V | CH | UMK105CH070DV-F | K22178255 | | 1- | B | e2 |
| C 1257 | CHIP CAP. | 0.001uF | 50V | B | UMK105B102KW-F | K22178829 | | 1- | B | f3 |
| C 1258 | CHIP CAP. | 0.0047uF | 25V | B | TMK105B472KW-F | K22148831 | | 1- | A | E5 |
| C 1259 | CHIP CAP. | 0.01uF | 16V | B | GRM36B103K16PT | K22128804 | | 1- | B | f3 |
| C 1260 | CHIP CAP. | 0.01uF | 16V | B | GRM36B103K16PT | K22128804 | | 1- | B | d1 |
| C 1261 | CHIP CAP. | 47pF | 50V | CH | UMK105CH470JV-F | K22178274 | | 1- | B | h2 |
| C 1262 | CHIP CAP. | 0.001uF | 50V | B | UMK105B102KW-F | K22178829 | | 1- | B | e2 |
| C 1263 | CHIP TA.CAP. | 10uF | 10V | | TEMSVA1A106M-8R | K78100028 | | 1- | B | e3 |
| C 1264 | CHIP CAP. | 0.001uF | 50V | B | UMK105B102KW-F | K22178829 | | 1- | B | e2 |
| C 1266 | CHIP CAP. | 0.01uF | 16V | B | GRM36B103K16PT | K22128804 | | 1- | A | E5 |
| C 1267 | CHIP CAP. | 18pF | 50V | CH | UMK105CH180JV-F | K22178264 | | 1- | A | B3 |
| C 1268 | CHIP CAP. | 82pF | 50V | UJ | GRM1553U1H820JZ01D | K22178322 | | 1- | B | f3 |
| C 1269 | CHIP CAP. | 0.01uF | 16V | B | GRM36B103K16PT | K22128804 | | 1- | A | B3 |
| C 1270 | CHIP CAP. | 0.001uF | 50V | B | GRM188B11H102KA01D | K22174821 | | 1- | A | D2 |
| C 1271 | CHIP CAP. | 0.001uF | 50V | B | GRM188B11H102KA01D | K22174821 | | 1- | A | D2 |
| C 1272 | CHIP CAP. | 0.001uF | 50V | B | UMK105B102KW-F | K22178829 | | 1- | B | e2 |
| C 1273 | CHIP CAP. | 0.001uF | 50V | B | UMK105B102KW-F | K22178829 | | 1- | B | c2 |
| C 1274 | CHIP CAP. | 1uF | 10V | B | GRM40B105K10PT | K22100802 | | 1- | B | c2 |
| C 1275 | CHIP CAP. | 0.022uF | 16V | B | EMK105B223KW-F | K22128813 | | 1- | B | c2 |
| C 1276 | CHIP CAP. | 2pF | 50V | CK | UMK105CK020CV-F | K22178250 | | 1- | B | g3 |
| C 1277 | CHIP CAP. | 82pF | 50V | UJ | GRM1553U1H820JZ01D | K22178322 | | 1- | B | f3 |
| C 1278 | CHIP CAP. | 0.01uF | 16V | B | GRM36B103K16PT | K22128804 | | 1- | B | c2 |
| C 1279 | CHIP CAP. | 1uF | 10V | B | GRM40B105K10PT | K22100802 | | 1- | B | c2 |
| C 1280 | CHIP CAP. | 0.1uF | 16V | B | GRM188B11C104KA01D | K22124805 | | 1- | A | D2 |
| C 1281 | CHIP CAP. | 0.1uF | 16V | B | GRM188B11C104KA01D | K22124805 | | 1- | A | D2 |
| C 1282 | CHIP TA.CAP. | 10uF | 10V | | TEMSVA1A106M-8R | K78100028 | | 1- | A | E1 |
| C 1283 | CHIP CAP. | 0.01uF | 16V | B | GRM36B103K16PT | K22128804 | | 1- | B | c1 |
| C 1284 | CHIP CAP. | 15pF | 50V | CH | UMK105CH150JV-F | K22178262 | | 1- | A | B3 |
| C 1285 | CHIP CAP. | 10pF | 50V | CH | UMK105CH100DV-F | K22178258 | | 1- | B | c2 |
| C 1286 | CHIP TA.CAP. | 1uF | 16V | | TESVA1C105M1-8R | K78120009 | | 1- | B | c1 |
| C 1287 | CHIP CAP. | 0.01uF | 16V | B | GRM36B103K16PT | K22128804 | | 1- | A | D2 |
| C 1288 | CHIP CAP. | 18pF | 50V | CH | UMK105CH180JV-F | K22178264 | | 1- | A | C2 |
| C 1289 | CHIP CAP. | 0.01uF | 16V | B | GRM36B103K16PT | K22128804 | | 1- | A | C2 |
| C 1290 | CHIP CAP. | 0.001uF | 50V | B | UMK105B102KW-F | K22178829 | | 1- | B | c2 |
| C 1291 | CHIP CAP. | 0.001uF | 50V | B | UMK105B102KW-F | K22178829 | | 1- | A | B3 |
| C 1292 | CHIP CAP. | 0.001uF | 50V | B | UMK105B102KW-F | K22178829 | | 1- | B | e2 |
| C 1293 | CHIP TA.CAP. | 4.7uF | 10V | | TEMSVA21A475M-8R | K78100045 | | 1- | B | h2 |
| C 1295 | CHIP CAP. | 0.01uF | 16V | B | GRM36B103K16PT | K22128804 | | 1- | B | h2 |
| C 1296 | CHIP CAP. | 0.001uF | 50V | B | UMK105B102KW-F | K22178829 | | 1- | B | e2 |
| C 1298 | CHIP CAP. | 15pF | 50V | CH | UMK105CH150JV-F | K22178262 | | 1- | B | e2 |
| C 1298 | CHIP CAP. | 47pF | 50V | CH | UMK105CH470JV-F | K22178274 | | 67- | B | e2 |
| C 1299 | CHIP CAP. | 0.001uF | 50V | B | UMK105B102KW-F | K22178829 | | 1- | A | B3 |
| C 1300 | CHIP CAP. | 0.01uF | 16V | B | GRM36B103K16PT | K22128804 | | 1- | A | D2 |
| C 1301 | CHIP CAP. | 0.01uF | 16V | B | GRM36B103K16PT | K22128804 | | 1- | B | h2 |
| C 1302 | CHIP CAP. | 8pF | 50V | CH | UMK105CH080DV-F | K22178256 | | 1- | A | C3 |
| C 1302 | CHIP CAP. | 15pF | 50V | CH | UMK105CH150JV-F | K22178262 | | 18- | A | C3 |
| C 1303 | CHIP CAP. | 0.001uF | 50V | B | UMK105B102KW-F | K22178829 | | 1- | B | e2 |
| C 1304 | CHIP CAP. | 0.1uF | 16V | B | GRM188B11C104KA01D | K22124805 | | 1- | B | h2 |
| C 1305 | CHIP CAP. | 22pF | 50V | CH | UMK105CH220JV-F | K22178266 | | 1- | A | D3 |
| C 1305 | CHIP CAP. | 0.001uF | 50V | B | UMK105B102KW-F | K22178829 | | 18- | A | D3 |
| C 1306 | CHIP CAP. | 0.01uF | 16V | B | GRM36B103K16PT | K22128804 | | 1- | A | D3 |
| C 1307 | CHIP CAP. | 0.01uF | 16V | B | GRM36B103K16PT | K22128804 | | 1- | B | h2 |
| C 1308 | CHIP CAP. | 0.001uF | 50V | B | UMK105B102KW-F | K22178829 | | 1- | A | D3 |
| C 1308 | CHIP CAP. | 33pF | 50V | CH | UMK105CH330JV-F | K22178270 | | 18- | A | D3 |
| C 1309 | CHIP CAP. | 0.01uF | 16V | B | GRM36B103K16PT | K22128804 | | 1- | A | E2 |
| C 1310 | CHIP CAP. | 0.1uF | 16V | B | GRM188B11C104KA01D | K22124805 | | 1- | A | E5 |
| C 1311 | CHIP CAP. | 0.01uF | 16V | B | GRM36B103K16PT | K22128804 | | 1- | B | h2 |
| C 1312 | CHIP TA.CAP. | 4.7uF | 6.3V | | TESVSP0J475M-8R | K78080053 | | 1- | B | f3 |
| C 1313 | CHIP CAP. | 0.01uF | 16V | B | GRM36B103K16PT | K22128804 | | 1- | A | D3 |
| C 1314 | CHIP CAP. | 15pF | 50V | CH | UMK105CH150JV-F | K22178262 | | 1- | A | D3 |
| C 1314 | CHIP CAP. | 18pF | 50V | CH | UMK105CH180JV-F | K22178264 | | 18- | A | D3 |
| C 1315 | CHIP CAP. | 0.033uF | 10V | BJ | LMK105BJ333KV-F | K22108804 | | 1- | A | E5 |
| C 1316 | CHIP CAP. | 0.01uF | 16V | B | GRM36B103K16PT | K22128804 | | 1- | B | f3 |
| C 1318 | CHIP CAP. | 0.01uF | 16V | B | GRM36B103K16PT | K22128804 | | 1- | B | e2 |
| C 1319 | CHIP CAP. | 0.001uF | 50V | B | UMK105B102KW-F | K22178829 | | 1- | B | h2 |
| C 1320 | CHIP CAP. | 0.01uF | 50V | B | GRM188B11H103KA01D | K22174823 | | 1- | A | A4 |
| C 1321 | CHIP CAP. | 0.01uF | 16V | B | GRM36B103K16PT | K22128804 | | 1- | A | A4 |

MAIN Unit

Parts List

| REF | DESCRIPTION | VALUE | V/W | TOL. | MFR'S DESIG | VXSTD P/N | VERS. | LOT | SIDE | LAY ADR |
|--------|--------------|----------|-----|------|--------------------|-----------|-------|-----|------|---------|
| C 1322 | CHIP CAP. | 0.01uF | 16V | B | GRM36B103K16PT | K22128804 | | 1- | A | A4 |
| C 1323 | CHIP TA.CAP. | 10uF | 10V | | TEMSVA1A106M-8R | K78100028 | | 1- | A | A4 |
| C 1324 | CHIP TA.CAP. | 2.2uF | 10V | | TESVA1A225M1-8R | K78100021 | | 1- | B | f4 |
| C 1325 | CHIP CAP. | 0.0047uF | 25V | B | TMK105B472KW-F | K22148831 | | 1- | A | D5 |
| C 1326 | CHIP TA.CAP. | 1uF | 16V | | TESVA1C105M1-8R | K78120009 | | 1- | B | e4 |
| C 1327 | CHIP CAP. | 0.1uF | 16V | B | GRM188B11C104KA01D | K22124805 | | 1- | B | f4 |
| C 1328 | CHIP CAP. | 0.01uF | 16V | B | GRM36B103K16PT | K22128804 | | 1- | B | g5 |
| C 1329 | CHIP CAP. | 0.01uF | 16V | B | GRM36B103K16PT | K22128804 | | 1- | B | g4 |
| C 1330 | CHIP CAP. | 0.01uF | 16V | B | GRM36B103K16PT | K22128804 | | 1- | B | e4 |
| C 1333 | CHIP CAP. | 0.01uF | 16V | B | GRM36B103K16PT | K22128804 | | 1- | A | E5 |
| C 1334 | CHIP TA.CAP. | 10uF | 10V | | TEMSVA1A106M-8R | K78100028 | | 1- | A | B4 |
| C 1336 | CHIP TA.CAP. | 0.47uF | 25V | | TESVA1E474M1-8R | K78140009 | | 1- | A | A5 |
| C 1337 | CHIP CAP. | 0.01uF | 16V | B | GRM36B103K16PT | K22128804 | | 1- | B | g4 |
| C 1338 | CHIP CAP. | 0.01uF | 16V | B | GRM36B103K16PT | K22128804 | | 1- | A | C3 |
| C 1340 | CHIP CAP. | 0.1uF | 16V | B | GRM188B11C104KA01D | K22124805 | | 1- | A | B4 |
| C 1341 | CHIP CAP. | 0.001uF | 50V | B | UMK105B102KW-F | K22178829 | | 1- | A | B4 |
| C 1342 | CHIP CAP. | 0.1uF | 16V | B | GRM188B11C104KA01D | K22124805 | | 1- | A | B4 |
| C 1344 | CHIP CAP. | 0.001uF | 50V | B | UMK105B102KW-F | K22178829 | | 1- | A | B4 |
| C 1345 | CHIP CAP. | 0.1uF | 16V | B | GRM188B11C104KA01D | K22124805 | | 1- | B | g4 |
| C 1346 | CHIP CAP. | 1uF | 10V | B | GRM40B105K10PT | K22100802 | | 1- | B | h4 |
| C 1347 | CHIP TA.CAP. | 10uF | 10V | | TEMSVA1A106M-8R | K78100028 | | 1- | A | B4 |
| C 1350 | CHIP CAP. | 0.01uF | 16V | B | GRM36B103K16PT | K22128804 | | 1- | A | B3 |
| C 1351 | CHIP CAP. | 0.047uF | 10V | BJ | LMK105BJ473KV-F | K22108805 | | 1- | B | h5 |
| C 1352 | CHIP CAP. | 15pF | 50V | CH | UMK105CH150JV-F | K22178262 | | 1- | B | e4 |
| C 1352 | CHIP CAP. | 33pF | 50V | CH | UMK105CH330JV-F | K22178270 | | 57- | B | e4 |
| C 1353 | CHIP CAP. | 0.1uF | 10V | B | GRM155B11A104KA01D | K22108802 | | 1- | A | B4 |
| C 1355 | CHIP CAP. | 15pF | 50V | CH | UMK105CH150JV-F | K22178262 | | 1- | A | C4 |
| C 1356 | CHIP CAP. | 0.1uF | 16V | B | GRM188B11C104KA01D | K22124805 | | 1- | A | D5 |
| C 1357 | CHIP CAP. | 1uF | 10V | B | GRM40B105K10PT | K22100802 | | 1- | B | g3 |
| C 1358 | CHIP CAP. | 1uF | 10V | B | GRM40B105K10PT | K22100802 | | 1- | B | f3 |
| C 1359 | CHIP CAP. | 100pF | 50V | CH | UMK105CH101JV-F | K22178282 | | 1- | A | B3 |
| C 1360 | CHIP CAP. | 0.001uF | 50V | B | UMK105B102KW-F | K22178829 | | 1- | B | h5 |
| C 1361 | CHIP CAP. | 1uF | 10V | B | GRM40B105K10PT | K22100802 | | 1- | B | g4 |
| C 1362 | CHIP CAP. | 0.1uF | 16V | B | GRM188B11C104KA01D | K22124805 | | 1- | B | g4 |
| C 1363 | CHIP CAP. | 33pF | 50V | CH | UMK105CH330JV-F | K22178270 | | 1- | B | e5 |
| C 1364 | CHIP CAP. | 0.1uF | 16V | B | GRM188B11C104KA01D | K22124805 | | 1- | B | h5 |
| C 1365 | CHIP CAP. | 0.001uF | 50V | B | UMK105B102KW-F | K22178829 | | 1- | A | B4 |
| C 1366 | CHIP TA.CAP. | 10uF | 10V | | TEMSVA1A106M-8R | K78100028 | | 1- | A | A4 |
| C 1367 | CHIP CAP. | 0.01uF | 16V | B | GRM36B103K16PT | K22128804 | | 1- | B | e4 |
| C 1368 | CHIP CAP. | 0.01uF | 16V | B | GRM36B103K16PT | K22128804 | | 1- | B | e5 |
| C 1369 | CHIP CAP. | 0.01uF | 16V | B | GRM36B103K16PT | K22128804 | | 1- | B | g4 |
| C 1370 | CHIP CAP. | 0.01uF | 16V | B | GRM36B103K16PT | K22128804 | | 1- | A | B4 |
| C 1371 | CHIP CAP. | 0.01uF | 16V | B | GRM36B103K16PT | K22128804 | | 1- | B | h5 |
| C 1372 | CHIP TA.CAP. | 10uF | 10V | | TEMSVA1A106M-8R | K78100028 | | 1- | B | g4 |
| C 1375 | CHIP CAP. | 0.1uF | 16V | B | GRM188B11C104KA01D | K22124805 | | 1- | B | e5 |
| C 1376 | CHIP CAP. | 0.0033uF | 50V | B | UMK105B332KW-F | K22178835 | | 1- | A | B3 |
| C 1378 | CHIP CAP. | 0.01uF | 16V | B | GRM36B103K16PT | K22128804 | | 1- | B | g4 |
| C 1379 | CHIP CAP. | 7pF | 50V | CH | UMK105CH070DV-F | K22178255 | | 1- | A | C4 |
| C 1380 | CHIP CAP. | 270pF | 25V | CH | GRM36CH271J25PT | K22148248 | | 1- | B | g5 |
| C 1381 | CHIP CAP. | 0.01uF | 16V | B | GRM36B103K16PT | K22128804 | | 1- | A | B4 |
| C 1382 | CHIP CAP. | 0.001uF | 50V | B | UMK105B102KW-F | K22178829 | | 1- | B | h5 |
| C 1383 | CHIP CAP. | 0.0015uF | 50V | B | UMK105B152KW-F | K22178831 | | 1- | A | B3 |
| C 1384 | CHIP CAP. | 1uF | 10V | B | GRM40B105K10PT | K22100802 | | 18- | B | c5 |
| C 1385 | CHIP CAP. | 1uF | 10V | B | GRM40B105K10PT | K22100802 | | 18- | B | c5 |
| C 1386 | CHIP CAP. | 220pF | 25V | CH | TMK105CH221JV-F | K22148246 | | 1- | B | e5 |
| C 1387 | CHIP TA.CAP. | 10uF | 10V | | TEMSVA1A106M-8R | K78100028 | | 1- | A | C4 |
| C 1388 | CHIP CAP. | 0.01uF | 16V | B | GRM36B103K16PT | K22128804 | | 1- | A | C4 |
| C 1389 | CHIP CAP. | 0.01uF | 16V | B | GRM36B103K16PT | K22128804 | | 1- | A | B4 |
| C 1390 | CHIP CAP. | 0.01uF | 16V | B | GRM36B103K16PT | K22128804 | | 1- | B | h5 |
| C 1391 | CHIP CAP. | 100pF | 50V | CH | UMK105CH101JV-F | K22178282 | | 1- | B | h5 |
| C 1392 | CHIP CAP. | 0.1uF | 10V | B | GRM155B11A104KA01D | K22108802 | | 1- | A | C4 |
| C 1394 | CHIP CAP. | 100pF | 50V | CH | UMK105CH101JV-F | K22178282 | | 1- | B | h5 |
| C 1395 | CHIP CAP. | 0.1uF | 16V | B | GRM188B11C104KA01D | K22124805 | | 1- | A | C4 |
| C 1396 | CHIP CAP. | 1uF | 10V | B | GRM40B105K10PT | K22100802 | | 1- | B | g3 |
| C 1397 | CHIP TA.CAP. | 10uF | 10V | | TEMSVA1A106M-8R | K78100028 | | 1- | B | g3 |
| C 1398 | CHIP CAP. | 33pF | 50V | CH | UMK105CH330JV-F | K22178270 | | 1- | B | e5 |
| C 1399 | CHIP CAP. | 0.01uF | 16V | B | GRM36B103K16PT | K22128804 | | 1- | A | D4 |
| C 1400 | CHIP CAP. | 0.01uF | 50V | B | GRM188B11H103KA01D | K22174823 | | 1- | A | B4 |
| C 1401 | CHIP CAP. | 0.01uF | 16V | B | GRM36B103K16PT | K22128804 | | 1- | A | D5 |
| C 1403 | CHIP CAP. | 0.01uF | 16V | B | GRM36B103K16PT | K22128804 | | 1- | A | C4 |
| C 1404 | CHIP CAP. | 0.1uF | 16V | B | GRM188B11C104KA01D | K22124805 | | 1- | B | d5 |
| C 1405 | CHIP CAP. | 0.001uF | 50V | B | UMK105B102KW-F | K22178829 | | 1- | A | C3 |
| C 1406 | CHIP CAP. | 33pF | 50V | CH | UMK105CH330JV-F | K22178270 | | 1- | B | g4 |

MAIN Unit

Parts List

| REF | DESCRIPTION | VALUE | V/W | TOL. | MFR'S DESIG | VXSTD P/N | VERS. | LOT | SIDE | LAY ADR |
|--------|--------------|----------|-----|------|--------------------|-----------|-------|-----|------|---------|
| C 1406 | CHIP CAP. | 5pF | 50V | CH | UMK105CH050CV-F | K22178253 | | 18- | B | g4 |
| C 1407 | CHIP CAP. | 56pF | 50V | CH | UMK105CH560JV-F | K22178276 | | 1- | B | g5 |
| C 1408 | CHIP CAP. | 0.1uF | 16V | B | GRM188B11C104KA01D | K22124805 | | 1- | B | g5 |
| C 1409 | CHIP CAP. | 2pF | 50V | CK | UMK105CK020CV-F | K22178250 | | 1- | A | C4 |
| C 1410 | CHIP CAP. | 1uF | 10V | B | GRM40B105K10PT | K22100802 | | 1- | B | g4 |
| C 1411 | CHIP CAP. | 0.01uF | 16V | B | GRM36B103K16PT | K22128804 | | 1- | B | g5 |
| C 1412 | CHIP CAP. | 0.1uF | 16V | B | GRM188B11C104KA01D | K22124805 | | 1- | B | g3 |
| C 1413 | CHIP CAP. | 0.1uF | 16V | B | GRM188B11C104KA01D | K22124805 | | 1- | A | D5 |
| C 1414 | CHIP CAP. | 0.01uF | 16V | B | GRM36B103K16PT | K22128804 | | 1- | B | e5 |
| C 1415 | CHIP CAP. | 0.1uF | 16V | B | GRM188B11C104KA01D | K22124805 | | 1- | B | g6 |
| C 1416 | CHIP CAP. | 0.1uF | 16V | B | GRM188B11C104KA01D | K22124805 | | 1- | B | g5 |
| C 1417 | CHIP CAP. | 0.1uF | 16V | B | GRM188B11C104KA01D | K22124805 | | 1- | A | B5 |
| C 1418 | CHIP CAP. | 0.01uF | 16V | B | GRM36B103K16PT | K22128804 | | 1- | A | D5 |
| C 1419 | CHIP CAP. | 0.01uF | 16V | B | GRM36B103K16PT | K22128804 | | 1- | B | g5 |
| C 1420 | CHIP CAP. | 0.1uF | 16V | B | GRM188B11C104KA01D | K22124805 | | 1- | A | A5 |
| C 1421 | CHIP CAP. | 18pF | 50V | CH | UMK105CH180JV-F | K22178264 | | 1- | A | C5 |
| C 1422 | CHIP CAP. | 10pF | 50V | CH | UMK105CH100DV-F | K22178258 | | 1- | B | e4 |
| C 1422 | CHIP CAP. | 3pF | 50V | CJ | UMK105CJ030CV-F | K22178251 | | 76- | B | e4 |
| C 1423 | CHIP TA.CAP. | 10uF | 10V | | TEMSVA1A106M-8R | K78100028 | | 1- | A | A5 |
| C 1424 | CHIP CAP. | 0.01uF | 16V | B | GRM36B103K16PT | K22128804 | | 1- | B | g5 |
| C 1425 | CHIP CAP. | 0.01uF | 16V | B | GRM36B103K16PT | K22128804 | | 1- | B | g5 |
| C 1426 | CHIP CAP. | 270pF | 25V | CH | GRM36CH271J25PT | K22148248 | | 1- | A | B5 |
| C 1427 | CHIP CAP. | 0.01uF | 16V | B | GRM36B103K16PT | K22128804 | | 1- | B | g4 |
| C 1428 | CHIP CAP. | 33pF | 50V | CH | UMK105CH330JV-F | K22178270 | | 1- | A | D5 |
| C 1429 | CHIP CAP. | 0.1uF | 16V | B | GRM188B11C104KA01D | K22124805 | | 1- | B | h6 |
| C 1430 | CHIP CAP. | 0.001uF | 50V | B | UMK105B102KW-F | K22178829 | | 1- | B | f3 |
| C 1431 | CHIP CAP. | 0.1uF | 10V | B | GRM155B11A104KA01D | K22108802 | | 1- | A | C4 |
| C 1432 | CHIP CAP. | 0.1uF | 16V | B | GRM188B11C104KA01D | K22124805 | | 1- | B | f5 |
| C 1433 | CHIP CAP. | 22pF | 50V | CH | UMK105CH220JV-F | K22178266 | | 1- | A | C4 |
| C 1433 | CHIP CAP. | 39pF | 50V | CH | UMK105CH390JV-F | K22178272 | | 18- | A | C4 |
| C 1433 | CHIP CAP. | 68pF | 50V | CH | UMK105CH680JV-F | K22178278 | | 67- | A | C4 |
| C 1433 | CHIP CAP. | 0.01uF | 25V | B | GRM155B11E103KA01D | K22148834 | | 79- | A | C4 |
| C 1434 | CHIP CAP. | 33pF | 50V | CH | UMK105CH330JV-F | K22178270 | | 1- | B | g5 |
| C 1435 | CHIP CAP. | 1uF | 10V | B | GRM40B105K10PT | K22100802 | | 1- | B | h3 |
| C 1436 | CHIP CAP. | 0.01uF | 16V | B | GRM36B103K16PT | K22128804 | | 1- | B | f3 |
| C 1437 | CHIP CAP. | 0.1uF | 16V | B | GRM188B11C104KA01D | K22124805 | | 1- | B | g5 |
| C 1439 | CHIP CAP. | 0.01uF | 16V | B | GRM36B103K16PT | K22128804 | | 18- | B | b4 |
| C 1440 | CHIP CAP. | 220pF | 25V | CH | TMK105CH221JV-F | K22148246 | | 1- | B | g5 |
| C 1441 | CHIP CAP. | 0.01uF | 16V | B | GRM36B103K16PT | K22128804 | | 1- | A | B5 |
| C 1442 | CHIP CAP. | 0.1uF | 16V | B | GRM188B11C104KA01D | K22124805 | | 1- | B | g5 |
| C 1443 | CHIP CAP. | 0.1uF | 16V | B | GRM188B11C104KA01D | K22124805 | | 1- | A | D5 |
| C 1444 | CHIP CAP. | 0.01uF | 16V | B | GRM36B103K16PT | K22128804 | | 1- | B | f3 |
| C 1445 | CHIP TA.CAP. | 10uF | 10V | | TEMSVA1A106M-8R | K78100028 | | 1- | A | C4 |
| C 1446 | CHIP CAP. | 1uF | 10V | B | GRM40B105K10PT | K22100802 | | 18- | B | c5 |
| C 1447 | CHIP CAP. | 0.01uF | 16V | B | GRM36B103K16PT | K22128804 | | 1- | A | D5 |
| C 1448 | CHIP CAP. | 0.1uF | 16V | B | GRM188B11C104KA01D | K22124805 | | 1- | A | C4 |
| C 1449 | CHIP CAP. | 0.1uF | 16V | B | GRM188B11C104KA01D | K22124805 | | 1- | B | g5 |
| C 1450 | CHIP CAP. | 1uF | 10V | B | GRM40B105K10PT | K22100802 | | 18- | B | c5 |
| C 1451 | CHIP CAP. | 0.1uF | 16V | B | GRM188B11C104KA01D | K22124805 | | 1- | A | C4 |
| C 1452 | CHIP CAP. | 0.0015uF | 50V | B | UMK105B152KW-F | K22178831 | | 18- | B | c6 |
| C 1453 | CHIP CAP. | 0.0015uF | 50V | B | UMK105B152KW-F | K22178831 | | 18- | B | c5 |
| C 1454 | CHIP CAP. | 0.0018uF | 50V | B | GRM188B11H182KA01D | K22174812 | | 18- | B | c5 |
| C 1455 | CHIP TA.CAP. | 10uF | 10V | | TEMSVA1A106M-8R | K78100028 | | 1- | B | e5 |
| C 1456 | CHIP CAP. | 100pF | 50V | CH | UMK105CH101JV-F | K22178282 | | 1- | A | B3 |
| C 1457 | CHIP TA.CAP. | 10uF | 10V | | TEMSVA1A106M-8R | K78100028 | | 1- | B | g3 |
| C 1458 | CHIP CAP. | 0.01uF | 16V | B | GRM36B103K16PT | K22128804 | | 1- | B | g5 |
| C 1459 | CHIP TA.CAP. | 10uF | 10V | | TEMSVA1A106M-8R | K78100028 | | 18- | B | b5 |
| C 1460 | CHIP TA.CAP. | 10uF | 10V | | TEMSVA1A106M-8R | K78100028 | | 18- | B | b4 |
| C 1461 | CHIP TA.CAP. | 10uF | 10V | | TEMSVA1A106M-8R | K78100028 | | 18- | B | b4 |
| C 1462 | CHIP CAP. | 0.1uF | 16V | B | GRM188B11C104KA01D | K22124805 | | 1- | B | g5 |
| C 1463 | CHIP CAP. | 0.1uF | 16V | B | GRM188B11C104KA01D | K22124805 | | 18- | B | b5 |
| C 1464 | CHIP CAP. | 1uF | 10V | B | GRM40B105K10PT | K22100802 | | 1- | B | f3 |
| C 1465 | CHIP CAP. | 0.012uF | 50V | B | GRM188B11H123KA01D | K22174825 | | 18- | B | c5 |
| C 1466 | CHIP CAP. | 220pF | 25V | CH | TMK105CH221JV-F | K22148246 | | 1- | A | D6 |
| C 1467 | CHIP CAP. | 0.01uF | 16V | B | GRM36B103K16PT | K22128804 | | 18- | B | b5 |
| C 1468 | CHIP CAP. | 0.1uF | 16V | B | GRM188B11C104KA01D | K22124805 | | 18- | B | b4 |
| C 1469 | CHIP CAP. | 0.1uF | 16V | B | GRM188B11C104KA01D | K22124805 | | 18- | B | b4 |
| C 1470 | CHIP CAP. | 0.01uF | 16V | B | GRM36B103K16PT | K22128804 | | 1- | A | C5 |
| C 1471 | CHIP CAP. | 33pF | 50V | CH | UMK105CH330JV-F | K22178270 | | 1- | B | g5 |
| C 1472 | CHIP CAP. | 0.01uF | 16V | B | GRM36B103K16PT | K22128804 | | 1- | B | f4 |
| C 1472 | CHIP CAP. | 0.1uF | 10V | B | GRM155B11A104KA01D | K22108802 | | 7- | B | f4 |
| C 1473 | CHIP CAP. | 0.1uF | 16V | B | GRM188B11C104KA01D | K22124805 | | 1- | A | B3 |
| C 1474 | CHIP CAP. | 0.0047uF | 25V | B | TMK105B472KW-F | K22148831 | | 1- | B | g3 |

MAIN Unit

Parts List

| REF | DESCRIPTION | VALUE | V/W | TOL. | MFR'S DESIG | VXSTD P/N | VERS. | LOT | SIDE | LAY ADR |
|--------|-----------------|----------|-----|------|--------------------|-----------|-------|-----|------|---------|
| C 1475 | CHIP CAP. | 0.1uF | 16V | B | GRM188B11C104KA01D | K22124805 | | 1- | B | g3 |
| C 1476 | CHIP TA.CAP. | 2.2uF | 10V | | TESVA1A225M1-8R | K78100021 | | 1- | A | D6 |
| C 1477 | CHIP CAP. | 0.1uF | 16V | B | GRM188B11C104KA01D | K22124805 | | 1- | A | C5 |
| C 1478 | CHIP CAP. | 0.001uF | 50V | B | UMK105B102KW-F | K22178829 | | 1- | B | f4 |
| C 1479 | CHIP CAP. | 0.1uF | 16V | B | GRM188B11C104KA01D | K22124805 | | 1- | A | B5 |
| C 1480 | CHIP CAP. | 0.1uF | 16V | B | GRM188B11C104KA01D | K22124805 | | 1- | B | g6 |
| C 1481 | CHIP CAP. | 100pF | 50V | CH | UMK105CH101JV-F | K22178282 | | 1- | B | f4 |
| C 1482 | CHIP CAP. | 0.01uF | 16V | B | GRM36B103K16PT | K22128804 | | 1- | B | g3 |
| C 1483 | CHIP CAP. | 0.047uF | 10V | BJ | LMK105BJ473KV-F | K22108805 | | 1- | A | A5 |
| C 1483 | CHIP CAP. | 0.1uF | 10V | B | GRM155B11A104KA01D | K22108802 | | 18- | A | A5 |
| C 1484 | CHIP CAP. | 0.1uF | 16V | B | GRM188B11C104KA01D | K22124805 | | 1- | A | A4 |
| C 1486 | CHIP CAP. | 0.01uF | 16V | B | GRM36B103K16PT | K22128804 | | 18- | B | b5 |
| C 1487 | CHIP CAP. | 0.0047uF | 25V | B | TMK105B472KW-F | K22148831 | | 18- | B | c5 |
| C 1488 | CHIP CAP. | 0.1uF | 16V | B | GRM188B11C104KA01D | K22124805 | | 1- | A | C5 |
| C 1489 | CHIP CAP. | 0.01uF | 16V | B | GRM36B103K16PT | K22128804 | | 18- | B | c5 |
| C 1490 | CHIP CAP. | 0.1uF | 16V | B | GRM188B11C104KA01D | K22124805 | | 1- | B | f5 |
| C 1491 | CHIP TA.CAP. | 10uF | 10V | | TEMSVA1A106M-8R | K78100028 | | 1- | A | A5 |
| C 1492 | CHIP CAP. | 0.0047uF | 25V | B | TMK105B472KW-F | K22148831 | | 1- | B | g4 |
| C 1493 | CHIP CAP. | 0.0056uF | 25V | B | GRM155B11E562KA01D | K22148802 | | 18- | B | c5 |
| C 1494 | CHIP CAP. | 0.0047uF | 25V | B | TMK105B472KW-F | K22148831 | | 1- | B | g6 |
| C 1495 | CHIP CAP. | 0.01uF | 16V | B | GRM36B103K16PT | K22128804 | | 1- | B | g3 |
| C 1496 | CHIP CAP. | 0.1uF | 16V | B | GRM188B11C104KA01D | K22124805 | | 1- | A | C5 |
| C 1497 | CHIP CAP. | 0.1uF | 16V | B | GRM188B11C104KA01D | K22124805 | | 1- | A | B3 |
| C 1498 | CHIP CAP. | 0.1uF | 16V | B | GRM188B11C104KA01D | K22124805 | | 1- | B | g4 |
| C 1499 | CHIP TA.CAP. | 10uF | 10V | | TEMSVA1A106M-8R | K78100028 | | 1- | B | e5 |
| C 1500 | CHIP CAP. | 0.022uF | 16V | B | EMK105B223KW-F | K22128813 | | 1- | B | g4 |
| C 1502 | CHIP CAP. | 0.001uF | 50V | B | UMK105B102KW-F | K22178829 | | 1- | B | g3 |
| C 1503 | CHIP TA.CAP. | 1uF | 16V | | TESVA1C105M1-8R | K78120009 | | 1- | A | A4 |
| C 1503 | CHIP TA.CAP. | 2.2uF | 10V | | TESVA1A225M1-8R | K78100021 | | 18- | A | A4 |
| C 1504 | CHIP CAP. | 0.1uF | 16V | B | GRM188B11C104KA01D | K22124805 | | 1- | A | C6 |
| C 1505 | CHIP CAP. | 1uF | 10V | B | GRM40B105K10PT | K22100802 | | 18- | B | d5 |
| C 1506 | CHIP CAP. | 0.0033uF | 50V | B | UMK105B332KW-F | K22178835 | | 1- | B | g4 |
| C 1507 | CHIP CAP. | 1uF | 10V | B | GRM40B105K10PT | K22100802 | | 1- | B | g4 |
| C 1509 | CHIP TA.CAP. | 10uF | 10V | | TEMSVA1A106M-8R | K78100028 | | 1- | A | C6 |
| C 1510 | CHIP CAP. | 0.1uF | 16V | B | GRM188B11C104KA01D | K22124805 | | 1- | A | C6 |
| C 1511 | CHIP CAP. | 10pF | 50V | CH | UMK105CH100DV-F | K22178258 | | 1- | B | f5 |
| C 1512 | CHIP CAP. | 0.1uF | 16V | B | GRM188B11C104KA01D | K22124805 | | 1- | A | D6 |
| C 1513 | CHIP CAP. | 0.01uF | 16V | B | GRM36B103K16PT | K22128804 | | 18- | B | b5 |
| C 1516 | CHIP TA.CAP. | 10uF | 16V | | TEMSVB21C106M-8R | K78120025 | | 1- | B | d6 |
| C 1517 | CHIP TA.CAP. | 22uF | 16V | | TEMSVB21C226M-8R | K78120028 | | 1- | B | c6 |
| C 1518 | CHIP CAP. | 10pF | 50V | CH | UMK105CH100DV-F | K22178258 | | 1- | B | e5 |
| C 1519 | CHIP CAP. | 0.1uF | 16V | B | GRM188B11C104KA01D | K22124805 | | 1 | B | d6 |
| C 1519 | CHIP CAP. | 1uF | 10V | F | GRM188F11A105ZA01D | K22105001 | | 2- | B | d6 |
| C 1520 | CHIP CAP. | 47pF | 50V | CH | UMK105CH470JV-F | K22178274 | | 18- | B | b5 |
| C 1521 | CHIP CAP. | 0.01uF | 16V | B | GRM36B103K16PT | K22128804 | | 18- | B | c6 |
| C 1522 | CHIP CAP. | 0.01uF | 16V | B | GRM36B103K16PT | K22128804 | | 18- | B | b6 |
| C 1523 | CHIP CAP. | 10pF | 50V | CH | UMK105CH100DV-F | K22178258 | | 18- | B | b6 |
| C 1526 | CHIP CAP. | 33pF | 50V | CH | UMK105CH330JV-F | K22178270 | | 18- | B | b6 |
| C 1528 | CHIP CAP. | 0.1uF | 16V | B | GRM188B11C104KA01D | K22124805 | | 1- | B | e7 |
| C 1529 | CHIP CAP. | 0.1uF | 16V | B | GRM188B11C104KA01D | K22124805 | | 1- | B | e6 |
| C 1530 | CHIP CAP. | 0.01uF | 16V | B | GRM36B103K16PT | K22128804 | | 1- | B | e7 |
| C 1531 | CHIP CAP. | 0.01uF | 16V | B | GRM36B103K16PT | K22128804 | | 1- | B | e6 |
| C 1532 | AL.ELECTRO.CAP. | 1000uF | 16V | | RE3-16V102MH3# | K40129096 | | 1- | A | D7 |
| C 1533 | CHIP CAP. | 0.1uF | 16V | B | GRM188B11C104KA01D | K22124805 | | 1- | B | e7 |
| C 1534 | CHIP CAP. | 0.1uF | 16V | B | GRM188B11C104KA01D | K22124805 | | 1- | B | e6 |
| C 1535 | CHIP CAP. | 0.01uF | 16V | B | GRM36B103K16PT | K22128804 | | 1 | B | d6 |
| C 1535 | CHIP CAP. | 0.1uF | 10V | B | GRM155B11A104KA01D | K22108802 | | 2- | B | d6 |
| C 1536 | CHIP CAP. | 0.1uF | 16V | B | GRM188B11C104KA01D | K22124805 | | 1- | B | g5 |
| C 1537 | CHIP CAP. | 0.1uF | 16V | B | GRM188B11C104KA01D | K22124805 | | 1- | B | f5 |
| C 1539 | CHIP CAP. | 0.01uF | 16V | B | GRM36B103K16PT | K22128804 | | 1- | B | f6 |
| C 1540 | CHIP CAP. | 1uF | 10V | B | GRM40B105K10PT | K22100802 | | 1- | B | c6 |
| C 1541 | AL.ELECTRO.CAP. | 1000uF | 16V | | RE3-16V102MH3# | K40129096 | | 1- | A | E7 |
| C 1542 | AL.ELECTRO.CAP. | 47uF | 16V | | EEE1CA470SP | K48120005 | | 1- | A | E6 |
| C 1543 | CHIP CAP. | 0.1uF | 16V | B | GRM188B11C104KA01D | K22124805 | | 1- | B | g5 |
| C 1544 | CHIP CAP. | 0.1uF | 16V | B | GRM188B11C104KA01D | K22124805 | | 1- | B | f5 |
| C 1545 | CHIP CAP. | 0.1uF | 16V | B | GRM188B11C104KA01D | K22124805 | | 1- | B | g7 |
| C 1546 | CHIP CAP. | 0.1uF | 16V | B | GRM188B11C104KA01D | K22124805 | | 1- | B | g6 |
| C 1547 | CHIP CAP. | 0.01uF | 16V | B | GRM36B103K16PT | K22128804 | | 1- | B | f5 |
| C 1548 | CHIP CAP. | 0.01uF | 16V | B | GRM36B103K16PT | K22128804 | | 1- | B | g7 |
| C 1549 | CHIP CAP. | 0.01uF | 16V | B | GRM36B103K16PT | K22128804 | | 1- | B | g6 |
| C 1550 | AL.ELECTRO.CAP. | 470uF | 16V | | RE3-16V471MG3# | K40129066 | | 1- | A | E6 |
| C 1551 | CHIP CAP. | 0.1uF | 16V | B | GRM188B11C104KA01D | K22124805 | | 1- | B | d7 |
| C 1552 | CHIP CAP. | 0.1uF | 16V | B | GRM188B11C104KA01D | K22124805 | | 1- | B | g6 |

MAIN Unit

Parts List

| REF | DESCRIPTION | VALUE | V/W | TOL. | MFR'S DESIG | VXSTD P/N | VERS. | LOT | SIDE | LAY ADR |
|--------|--------------|---------|-----|------|--------------------|-----------|-------|-----|------|---------|
| C 1554 | CHIP TA.CAP. | 10uF | 10V | | TEMSVA1A106M-8R | K78100028 | | 1- | B | b6 |
| C 1555 | CHIP CAP. | 1uF | 10V | B | GRM40B105K10PT | K22100802 | | 1- | B | b6 |
| C 1557 | CHIP CAP. | 47pF | 50V | CH | UMK105CH470JV-F | K22178274 | | 1- | B | b6 |
| C 1558 | CHIP CAP. | 100pF | 50V | CH | UMK105CH101JV-F | K22178282 | | 1- | B | b6 |
| C 1559 | CHIP CAP. | 0.001uF | 50V | B | UMK105B102KW-F | K22178829 | | 1- | B | b7 |
| C 1560 | CHIP CAP. | 10pF | 50V | CH | UMK105CH100DV-F | K22178258 | | 1- | B | f5 |
| C 1562 | CHIP CAP. | 100pF | 50V | CH | UMK105CH101JV-F | K22178282 | | 1- | B | h4 |
| C 1563 | CHIP CAP. | 0.001uF | 50V | B | UMK105B102KW-F | K22178829 | | 1- | B | b7 |
| C 1564 | CHIP CAP. | 1uF | 10V | B | GRM40B105K10PT | K22100802 | | 1- | B | h4 |
| C 1565 | CHIP CAP. | 0.001uF | 50V | B | UMK105B102KW-F | K22178829 | | 1- | B | h3 |
| C 1566 | CHIP CAP. | 100pF | 50V | CH | UMK105CH101JV-F | K22178282 | | 1- | B | h3 |
| C 1567 | CHIP TA.CAP. | 10uF | 10V | | TEMSVA1A106M-8R | K78100028 | | 1- | A | G7 |
| C 1568 | CHIP CAP. | 470pF | 50V | B | UMK105B471KW-F | K22178825 | | 1- | B | a6 |
| C 1569 | CHIP CAP. | 0.1uF | 16V | B | GRM188B11C104KA01D | K22124805 | | 1- | B | b6 |
| C 1570 | CHIP CAP. | 0.001uF | 50V | B | UMK105B102KW-F | K22178829 | | 1- | A | G7 |
| C 1571 | CHIP CAP. | 470pF | 50V | B | UMK105B471KW-F | K22178825 | | 1- | B | a6 |
| C 1572 | CHIP CAP. | 0.001uF | 50V | B | UMK105B102KW-F | K22178829 | | 1- | B | h6 |
| C 1573 | CHIP CAP. | 0.001uF | 50V | B | UMK105B102KW-F | K22178829 | | 1- | A | A3 |
| C 1574 | CHIP CAP. | 0.001uF | 50V | B | UMK105B102KW-F | K22178829 | | 1- | B | h4 |
| C 1575 | CHIP CAP. | 0.001uF | 50V | B | UMK105B102KW-F | K22178829 | | 1- | B | h4 |
| C 1576 | CHIP CAP. | 0.001uF | 50V | B | UMK105B102KW-F | K22178829 | | 1- | B | h5 |
| C 1577 | CHIP CAP. | 0.001uF | 50V | B | UMK105B102KW-F | K22178829 | | 1- | B | h5 |
| C 1578 | CHIP CAP. | 0.001uF | 50V | B | UMK105B102KW-F | K22178829 | | 1- | B | h5 |
| C 1579 | CHIP CAP. | 0.001uF | 50V | B | UMK105B102KW-F | K22178829 | | 1- | B | h3 |
| C 1580 | CHIP CAP. | 0.001uF | 50V | B | UMK105B102KW-F | K22178829 | | 1- | A | G6 |
| C 1581 | CHIP CAP. | 1uF | 10V | F | GRM188F11A105ZA01D | K22105001 | | 1- | A | G6 |
| C 1582 | CHIP CAP. | 0.001uF | 50V | B | UMK105B102KW-F | K22178829 | | 1- | B | h6 |
| C 1583 | CHIP CAP. | 0.001uF | 50V | B | UMK105B102KW-F | K22178829 | | 1- | B | h5 |
| C 1586 | CHIP CAP. | 470pF | 50V | B | UMK105B471KW-F | K22178825 | | 1- | A | H6 |
| C 1587 | CHIP CAP. | 0.01uF | 50V | B | GRM188B11H103KA01D | K22174823 | | 1- | B | h3 |
| C 1588 | CHIP CAP. | 0.001uF | 50V | B | UMK105B102KW-F | K22178829 | | 1- | B | h4 |
| C 1589 | CHIP CAP. | 0.001uF | 50V | B | UMK105B102KW-F | K22178829 | | 1- | B | b6 |
| C 1590 | CHIP CAP. | 0.001uF | 50V | B | UMK105B102KW-F | K22178829 | | 1- | B | a6 |
| C 1591 | CHIP CAP. | 470pF | 50V | B | UMK105B471KW-F | K22178825 | | 1- | A | H5 |
| C 1592 | CHIP CAP. | 470pF | 50V | B | UMK105B471KW-F | K22178825 | | 1- | A | H5 |
| C 1593 | CHIP CAP. | 0.001uF | 50V | B | UMK105B102KW-F | K22178829 | | 1- | B | h7 |
| C 1594 | CHIP CAP. | 0.001uF | 50V | B | UMK105B102KW-F | K22178829 | | 1- | B | h7 |
| C 1595 | CHIP CAP. | 0.01uF | 16V | B | GRM36B103K16PT | K22128804 | | 1- | A | G7 |
| C 1596 | CHIP CAP. | 0.1uF | 16V | B | GRM188B11C104KA01D | K22124805 | | 1- | A | G7 |
| C 1597 | CHIP CAP. | 12pF | 50V | CH | UMK105CH120JV-F | K22178260 | | 1- | A | F2 |
| C 1598 | CHIP CAP. | 5pF | 50V | CH | UMK105CH050CV-F | K22178253 | | 1- | A | F2 |
| C 1599 | CHIP CAP. | 4pF | 50V | CH | UMK105CH040CV-F | K22178252 | | 1- | A | F2 |
| C 1600 | CHIP CAP. | 68pF | 50V | CH | UMK105CH680JV-F | K22178278 | | 1- | A | B5 |
| C 1601 | CHIP CAP. | 22pF | 50V | CH | UMK105CH220JV-F | K22178266 | | 1- | B | g4 |
| C 1601 | CHIP CAP. | 15pF | 50V | CH | UMK105CH150JV-F | K22178262 | | 18- | B | g4 |
| C 1602 | CHIP CAP. | 15pF | 50V | CH | UMK105CH150JV-F | K22178262 | | 1- | B | f4 |
| C 1603 | CHIP CAP. | 47pF | 50V | CH | UMK105CH470JV-F | K22178274 | | 1- | A | C5 |
| C 1604 | CHIP CAP. | 47pF | 50V | CH | UMK105CH470JV-F | K22178274 | | 1- | B | e5 |
| C 1605 | CHIP CAP. | 68pF | 50V | CH | UMK105CH680JV-F | K22178278 | | 1- | B | e5 |
| C 1606 | CHIP CAP. | 100pF | 50V | CH | UMK105CH101JV-F | K22178282 | | 1- | B | f6 |
| C 1607 | CHIP CAP. | 15pF | 50V | CH | UMK105CH150JV-F | K22178262 | | 1- | A | A3 |
| C 1608 | CHIP CAP. | 33pF | 50V | CH | UMK105CH330JV-F | K22178270 | | 1- | A | C5 |
| C 1608 | CHIP CAP. | 100pF | 50V | CH | UMK105CH101JV-F | K22178282 | | 76- | A | C5 |
| C 1609 | CHIP CAP. | 100pF | 50V | CH | UMK105CH101JV-F | K22178282 | | 1- | A | B3 |
| C 1610 | CHIP CAP. | 0.1uF | 16V | B | GRM188B11C104KA01D | K22124805 | | 1- | B | h3 |
| C 1613 | CHIP CAP. | 15pF | 50V | CH | GRM1882C1H150JA01D | K22174215 | | 1- | A | G3 |
| C 1613 | CHIP CAP. | 12pF | 50V | CH | GRM1882C1H120JA01D | K22174213 | | 42- | A | G3 |
| C 1614 | CHIP CAP. | 3pF | 50V | CJ | GRM1883C1H3R0CZ01D | K22174204 | | 1- | B | a2 |
| C 1615 | CHIP CAP. | 1uF | 10V | B | GRM40B105K10PT | K22100802 | | 1- | B | e1 |
| C 1616 | CHIP CAP. | 15pF | 50V | CH | UMK105CH150JV-F | K22178262 | | 1- | A | D1 |
| C 1617 | CHIP CAP. | 0.001uF | 50V | B | UMK105B102KW-F | K22178829 | | 1- | B | e5 |
| C 1618 | CHIP CAP. | 0.001uF | 50V | B | UMK105B102KW-F | K22178829 | | 1- | B | h2 |
| C 1619 | CHIP CAP. | 7pF | 50V | CH | UMK105CH070DV-F | K22178255 | | 1- | A | F2 |
| C 1619 | CHIP CAP. | 5pF | 50V | CH | UMK105CH050CV-F | K22178253 | | 42- | A | F2 |
| C 1620 | CHIP CAP. | 10pF | 50V | CH | UMK105CH100DV-F | K22178258 | | 1- | A | F2 |
| C 1633 | CHIP CAP. | 100pF | 50V | CH | UMK105CH101JV-F | K22178282 | | 1- | A | D3 |
| C 1634 | CHIP CAP. | 100pF | 50V | CH | UMK105CH101JV-F | K22178282 | | 1- | A | D3 |
| C 1635 | CHIP CAP. | 100pF | 50V | CH | UMK105CH101JV-F | K22178282 | | 1- | A | D3 |
| C 1636 | CHIP CAP. | 100pF | 50V | CH | UMK105CH101JV-F | K22178282 | | 1- | A | D3 |
| C 1637 | CHIP CAP. | 100pF | 50V | CH | UMK105CH101JV-F | K22178282 | | 1- | A | D3 |
| C 1638 | CHIP CAP. | 100pF | 50V | CH | UMK105CH101JV-F | K22178282 | | 1- | A | D3 |
| C 1639 | CHIP CAP. | 100pF | 50V | CH | UMK105CH101JV-F | K22178282 | | 1- | A | D3 |
| C 1640 | CHIP CAP. | 100pF | 50V | CH | UMK105CH101JV-F | K22178282 | | 1- | A | D3 |

MAIN Unit

Parts List

| REF | DESCRIPTION | VALUE | V/W | TOL. | MFR'S DESIG | VXSTD P/N | VERS. | LOT | SIDE | LAY ADR |
|--------|-------------------|----------|-----|------|----------------------|-----------|-------|-------|------|---------|
| C 1641 | CHIP CAP. | 100pF | 50V | CH | UMK105CH101JV-F | K22178282 | | 1- | A | D3 |
| C 1642 | CHIP CAP. | 100pF | 50V | CH | UMK105CH101JV-F | K22178282 | | 1- | A | D3 |
| C 1643 | CHIP CAP. | 0.001uF | 50V | B | UMK105B102KW-F | K22178829 | | 1- | B | d3 |
| C 1647 | CHIP CAP. | 10pF | 50V | CH | UMK105CH100DV-F | K22178258 | | 1- | B | e3 |
| C 1648 | CHIP CAP. | 0.01uF | 16V | B | GRM36B103K16PT | K22128804 | | 1- | A | G6 |
| C 1650 | CHIP CAP. | 0.001uF | 50V | B | GRM188B11H102KA01D | K22174821 | | 1- | B | b2 |
| C 1650 | CHIP CAP. | 220pF | 50V | CH | GRM1882C1H221JA01D | K22174243 | | 4- | B | b2 |
| C 1650 | CHIP CAP. | 150pF | 50V | CH | GRM1882C1H151JA01D | K22174239 | | 14- | B | b2 |
| C 1650 | CHIP CAP. | 100pF | 50V | CH | GRM1882C1H101JA01D | K22174235 | | 18- | B | b2 |
| C 1650 | CHIP CAP. | 100pF | 50V | CH | GRM1882C1H101JA01D | K22174235 | | 29-39 | B | b2 |
| C 1651 | CHIP CAP. | 0.001uF | 50V | B | UMK105B102KW-F | K22178829 | | 1- | A | F4 |
| C 1652 | CHIP TA.CAP. | 10uF | 10V | | TEMSVA1A106M-8R | K78100028 | | 1- | A | F1 |
| C 1656 | CHIP CAP. | 10pF | 50V | CH | UMK105CH100DV-F | K22178258 | | 1-17 | B | e2 |
| C 1660 | CHIP CAP. | 0.1uF | 10V | B | GRM155B11A104KA01D | K22108802 | | 1- | A | F5 |
| C 1661 | CHIP CAP. | 0.0033uF | 50V | B | UMK105B332KW-F | K22178835 | | 1 | B | c6 |
| C 1661 | CHIP CAP. | 0.01uF | 16V | B | GRM36B103K16PT | K22128804 | | 2- | B | c6 |
| C 1662 | CHIP CAP. | 4pF | 50V | CH | UMK105CH040CV-F | K22178252 | | 18- | B | b6 |
| C 1663 | CHIP CAP. | 100pF | 50V | CH | GRM1552C1H101JD01D | K22178236 | W/ CE | 1- | A | F4 |
| C 1663 | CHIP CAP. | 100pF | 50V | CH | GRM1552C1H101JD01D | K22178236 | W/ CE | 3- | A | F4 |
| C 1664 | CHIP CAP. | 100pF | 50V | CH | GRM1552C1H101JD01D | K22178236 | W/ CE | 1- | A | H4 |
| C 1664 | CHIP CAP. | 100pF | 50V | CH | GRM1552C1H101JD01D | K22178236 | W/ CE | 3- | A | H4 |
| C 1668 | CHIP CAP. | 0.001uF | 50V | B | UMK105B102KW-F | K22178829 | W/ CE | 3- | B | h7 |
| C 1672 | CHIP TA.CAP. | 1uF | 16V | | TESVA1C105M1-8R | K78120009 | | 1-17 | B | d5 |
| C 1674 | CHIP CAP. | 22pF | 50V | CH | GRM1882C1H220JA01D | K22174219 | W/ CE | 3 | A | E1 |
| C 1674 | CHIP CAP. | 22pF | 50V | CH | GRM1882C1H220JA01D | K22174219 | W/ CE | 4-17 | A | E1 |
| C 1674 | CHIP CAP. | 22pF | 50V | CH | UMK105CH220JV-F | K22178266 | | 18- | A | E1 |
| C 1675 | CHIP CAP. | 0.01uF | 16V | B | GRM36B103K16PT | K22128804 | | 4- | A | E1 |
| C 1677 | CHIP CAP. | 0.01uF | 16V | B | GRM36B103K16PT | K22128804 | | 4- | B | b2 |
| C 1678 | CHIP CAP. | 0.33uF | 16V | B | GRM40B334K16PT | K22120807 | | 5- | B | f3 |
| C 1679 | CHIP CAP. | 0.001uF | 50V | B | UMK105B102KW-F | K22178829 | | 18- | B | h5 |
| C 1680 | CHIP CAP. | 0.015uF | 16V | B | GRM155B11C153KA01D | K22128807 | | 8- | B | g3 |
| C 1680 | CHIP CAP. | 0.0047uF | 50V | B | GRM155B11H472KA01D | K22178838 | | 79- | B | g3 |
| C 1681 | CHIP CAP. | 18pF | 50V | CH | UMK105CH180JV-F | K22178264 | | 18- | A | D3 |
| C 1682 | CHIP CAP. | 1uF | 10V | F | GRM188F11A105ZA01D | K22105001 | | 18- | A | F5 |
| C 1683 | CHIP CAP. | 0.01uF | 16V | B | GRM36B103K16PT | K22128804 | | 18- | B | c2 |
| C 1684 | CHIP CAP. | 4pF | 50V | CH | GRM1882C1H4R0CZ01D | K22174205 | | 40-78 | | |
| C 1685 | CHIP CAP. | 0.001uF | 50V | B | UMK105B102KW-F | K22178829 | | 73- | | |
| CD1001 | CERAMIC DISC | | | | CDACV10M7GA001-R0-TC | H7901420 | | 1- | A | F2 |
| CD1002 | CERAMIC DISC | | | | CDBCBA455KCAAY24-R0 | H7900980 | | 1- | A | A5 |
| CF1001 | CERAMIC FILTER | | | | SFECV10M7FA00-R0-TC | H3900537 | | 1- | A | E2 |
| CF1002 | CERAMIC FILTER | | | | ALFYM455E=K | H3900543 | | 1- | A | B6 |
| CF1003 | CERAMIC FILTER | | | | ALFYM455G=K | H3900545 | | 1- | A | A6 |
| CF1004 | CERAMIC FILTER | | | | CFJ455K14 | H3900386 | | 1- | A | B5 |
| CF1005 | CERAMIC FILTER | | | | ALFYM455H=K | H3900542 | | 1- | A | B5 |
| CV1001 | HELICAL RESONATOR | 440MHZ | | | H5T-440 440M | L4020161 | | 1- | A | E3 |
| D 1001 | DIODE | | | | DAP236U T106 | G2070592 | | 1- | B | d4 |
| D 1002 | DIODE | | | | DAP236U T106 | G2070592 | | 1- | B | c4 |
| D 1003 | DIODE | | | | HSC277TRF-E | G2070584 | | 1- | A | E3 |
| D 1004 | DIODE | | | | BAS316 | G2070716 | | 1- | B | b1 |
| D 1005 | DIODE | | | | BAS316 | G2070716 | | 1- | B | a2 |
| D 1006 | DIODE | | | | UDZS TE-17 5.6B | G2070910 | | 1- | B | a2 |
| D 1007 | DIODE | | | | HSC277TRF-E | G2070584 | | 1- | B | d4 |
| D 1008 | DIODE | | | | 1SV278(TPH2.F) | G2070616 | | 1- | B | d3 |
| D 1009 | DIODE | | | | 1SV278(TPH2.F) | G2070616 | | 1- | B | c3 |
| D 1010 | DIODE | | | | 1SS302(TE85R.F) | G2070088 | | 1- | B | d4 |
| D 1011 | DIODE | | | | DAP236U T106 | G2070592 | | 1- | B | d4 |
| D 1012 | DIODE | | | | DAP236U T106 | G2070592 | | 1- | B | d3 |
| D 1013 | DIODE | | | | BAS316 | G2070716 | | 1- | B | c3 |
| D 1014 | DIODE | | | | 1SV278(TPH2.F) | G2070616 | | 1- | B | d2 |
| D 1015 | DIODE | | | | 1SV278(TPH2.F) | G2070616 | | 1- | B | c3 |
| D 1016 | DIODE | | | | HSC277TRF-E | G2070584 | | 1- | A | E3 |
| D 1017 | DIODE | | | | 1SV278(TPH2.F) | G2070616 | | 1- | B | c3 |
| D 1018 | DIODE | | | | DAP236U T106 | G2070592 | | 1- | B | c1 |
| D 1019 | DIODE | | | | DAP236U T106 | G2070592 | | 1- | A | E1 |
| D 1020 | DIODE | | | | RB051L-40TE25 | G2070718 | | 1- | B | c6 |
| D 1023 | DIODE | | | | 1SV278(TPH2.F) | G2070616 | | 1- | A | E1 |
| D 1024 | DIODE | | | | 1SV278(TPH2.F) | G2070616 | | 1- | A | E1 |
| D 1025 | DIODE | | | | DAP236U T106 | G2070592 | | 1- | B | d2 |
| D 1026 | DIODE | | | | 1SV278(TPH2.F) | G2070616 | | 1- | A | E1 |
| D 1027 | DIODE | | | | 1SV278(TPH2.F) | G2070616 | | 1- | A | E1 |
| D 1028 | DIODE | | | | 1SV278(TPH2.F) | G2070616 | | 1- | A | D1 |
| D 1029 | DIODE | | | | MA132WK-(TX) | G2070776 | | 1- | B | c6 |
| D 1029 | DIODE | | | | DAN222 TL | G2070174 | | 14- | B | c6 |

MAIN Unit

Parts List

| REF | DESCRIPTION | VALUE | V/W | TOL. | MFR'S DESIG | VXSTD P/N | VERS. | LOT | SIDE | LAY ADR |
|--------|---------------|-------|-----|------|------------------|-----------|-------|-------|------|---------|
| D 1030 | DIODE | | | | DAP236U T106 | G2070592 | | 1- | B | e1 |
| D 1031 | DIODE | | | | DAP236U T106 | G2070592 | | 1- | A | D1 |
| D 1032 | DIODE | | | | MC2850-T11-1 | G2070704 | | 1- | A | E6 |
| D 1033 | DIODE | | | | DAN222 TL | G2070174 | | 1- | B | c6 |
| D 1034 | DIODE | | | | HSB88WS TR-E | G2070290 | | 1- | A | D2 |
| D 1035 | DIODE | | | | DAP236U T106 | G2070592 | | 1- | B | d2 |
| D 1036 | DIODE | | | | HSC277TRF-E | G2070584 | | 1- | B | d3 |
| D 1037 | DIODE | | | | DA221 TL | G2070178 | | 1- | B | f3 |
| D 1038 | DIODE | | | | 1SV217(TPH3) | G2070568 | | 1- | A | E1 |
| D 1038 | DIODE | | | | 1SV262(TPH3) | G2071106 | | 55- | A | E1 |
| D 1039 | DIODE | | | | DAN235U TL | G2070176 | | 1- | B | e1 |
| D 1040 | DIODE | | | | 1SV271(TPH3.F) | G2070476 | | 1- | B | e2 |
| D 1041 | DIODE | | | | BAS316 | G2070716 | | 1- | B | d1 |
| D 1043 | DIODE | | | | DA221 TL | G2070178 | | 1- | A | C3 |
| D 1044 | DIODE | | | | IMN10 T108 | G2070078 | | 1- | A | F6 |
| D 1045 | DIODE | | | | HSC277TRF-E | G2070584 | | 1- | B | e2 |
| D 1046 | DIODE | | | | 1SV229(TPH3.F) | G2070256 | | 1- | A | B3 |
| D 1047 | DIODE | | | | IMN10 T108 | G2070078 | | 1- | A | F6 |
| D 1048 | DIODE | | | | IMN10 T108 | G2070078 | | 1- | A | F6 |
| D 1049 | DIODE | | | | DAN235U TL | G2070176 | | 1- | B | e3 |
| D 1050 | DIODE | | | | DAN235U TL | G2070176 | | 1- | B | e3 |
| D 1051 | DIODE | | | | BAS316 | G2070716 | | 1- | A | B3 |
| D 1052 | DIODE | | | | BAS316 | G2070716 | | 1- | B | h5 |
| D 1053 | DIODE | | | | BAS316 | G2070716 | | 1- | B | f4 |
| D 1054 | DIODE | | | | DAN235U TL | G2070176 | | 1- | B | e3 |
| D 1055 | DIODE | | | | BAS316 | G2070716 | | 1- | B | f4 |
| D 1056 | DIODE | | | | BAS316 | G2070716 | | 1- | A | B4 |
| D 1057 | DIODE | | | | DA221 TL | G2070178 | | 1- | B | h5 |
| D 1058 | DIODE | | | | 1SS372(TE85R.F) | G2070632 | | 1- | B | g3 |
| D 1059 | DIODE | | | | BAS316 | G2070716 | | 1- | B | g4 |
| D 1060 | DIODE | | | | 1SV271(TPH3.F) | G2070476 | | 1- | A | D4 |
| D 1061 | DIODE | | | | 1SS372(TE85R.F) | G2070632 | | 1- | A | B5 |
| D 1062 | DIODE | | | | BAS316 | G2070716 | | 1- | A | C4 |
| D 1063 | DIODE | | | | DAP222-TL | G2070432 | | 1- | B | g5 |
| D 1064 | DIODE | | | | 1SS372(TE85R.F) | G2070632 | | 1- | A | D6 |
| D 1065 | DIODE | | | | DAP222-TL | G2070432 | | 1- | B | g6 |
| D 1066 | DIODE | | | | BAS316 | G2070716 | | 1- | B | e5 |
| D 1068 | DIODE | | | | BAS316 | G2070716 | | 1- | A | B5 |
| D 1069 | DIODE | | | | DAN222 TL | G2070174 | | 1- | B | g5 |
| D 1070 | DIODE | | | | DAN222 TL | G2070174 | | 1- | B | e5 |
| D 1071 | DIODE | | | | BAS316 | G2070716 | | 1- | B | g6 |
| D 1072 | DIODE | | | | DAP222-TL | G2070432 | | 1- | B | e6 |
| D 1076 | DIODE | | | | DAP222-TL | G2070432 | | 1- | B | g6 |
| D 1077 | DIODE | | | | HZM27WA TR-E | G2070530 | | 1- | B | b7 |
| D 1078 | DIODE | | | | DAP222-TL | G2070432 | | 1- | B | g5 |
| D 1079 | DIODE | | | | DAP222-TL | G2070432 | | 1- | A | B6 |
| D 1080 | DIODE | | | | HZM27WA TR-E | G2070530 | | 1- | B | a5 |
| D 1081 | DIODE | | | | D1F20-5063 | G2070474 | | 1- | B | h3 |
| D 1082 | DIODE | | | | BAS316 | G2070716 | | 1- | B | d6 |
| D 1083 | DIODE | | | | DAN222 TL | G2070174 | | 1- | A | E5 |
| D 1084 | DIODE | | | | 1SS270TJ | G2060004 | | 7- | B | f4 |
| D 1084 | DIODE | | | | BAS316 | G2070716 | | 18- | B | f4 |
| D 1085 | DIODE | | | | EDZ TE61 18B | G2070968 | | 18- | B | c6 |
| D 1086 | DIODE | | | | EDZ TE61 18B | G2070968 | | 18- | B | c6 |
| D 1087 | DIODE | | | | UDZS TE-17 5.1B | G2070908 | | 18- | A | C4 |
| D 1088 | DIODE | | | | UDZS TE-17 5.1B | G2070908 | | 18- | B | f4 |
| D 1089 | DIODE | | | | UDZS TE-17 5.1B | G2070908 | | 18- | B | g5 |
| D 1090 | DIODE | | | | UDZS TE-17 5.1B | G2070908 | | 18- | A | C2 |
| D 1091 | DIODE | | | | BAS316 | G2070716 | | 18- | A | B5 |
| D 1092 | DIODE | | | | 1SV271(TPH3.F) | G2070476 | | 18-39 | B | c2 |
| D 1093 | DIODE | | | | HVC132TRF-E | G2071064 | | 40- | B | c1 |
| F 1001 | CHIP FUSE | 3.15A | | | KAB-2402-322NA31 | Q0000087 | | 1- | A | A3 |
| FB1002 | CHIP COIL | | | | BLM21PG300SN1D | L1690840 | | 1- | A | H1 |
| FB1003 | CHIP COIL | | | | BLM21PG300SN1D | L1690840 | | 1- | A | H1 |
| FB1004 | CHIP COIL | | | | BLM21PG300SN1D | L1690840 | | 1- | A | H1 |
| FB1005 | FERRITE BEADS | | | | SMB304729 | L9190094 | | 1- | A | G1 |
| FB1006 | CHIP COIL | | | | BLM21PG300SN1D | L1690840 | | 1- | A | H1 |
| FB1007 | CHIP COIL | | | | BLM21PG300SN1D | L1690840 | | 1- | B | a1 |
| FB1008 | CHIP COIL | | | | BLM21PG300SN1D | L1690840 | | 1- | B | h7 |
| FB1009 | CHIP COIL | | | | BLM21PG300SN1D | L1690840 | | 1- | B | h3 |
| FB1010 | CHIP COIL | | | | BLM21PG300SN1D | L1690840 | | 1- | B | h5 |
| FB1011 | CHIP COIL | | | | BLM21PG300SN1D | L1690840 | | 1- | A | G7 |
| FB1012 | CHIP COIL | | | | BLM21PG300SN1D | L1690840 | | 1- | A | G7 |

MAIN Unit

Parts List

| REF | DESCRIPTION | VALUE | V/W | TOL. | MFR'S DESIG | VXSTD P/N | VERS. | LOT | SIDE | LAY ADR |
|--------|-------------|----------|-----|------|--------------------------|-----------|-------|------|------|---------|
| FB1013 | CHIP COIL | | | | BLM21PG300SN1D | L1690840 | | 1- | B | a6 |
| FB1014 | CHIP COIL | | | | BLM21PG300SN1D | L1690840 | | 1- | B | h4 |
| J 1001 | CONNECTOR | | | | 24FLT-SM1-TB(LF)(SN) | P1091128 | | 1- | A | G1 |
| J 1002 | CONNECTOR | | | | TMP-J01X-A2 | P1090255 | | 1- | A | H5 |
| J 1002 | CONNECTOR | | | | TMP-S01X-C1 | P1091254 | | 47- | A | H5 |
| J 1003 | CONNECTOR | | | | TMP-J01X-A2 | P1090255 | | 1- | A | F4 |
| J 1003 | CONNECTOR | | | | TMP-S01X-C1 | P1091254 | | 47- | A | F4 |
| J 1004 | CONNECTOR | | | | IMSA-9202B-1-02-T | P0091174 | | 1- | A | F4 |
| J 1005 | CONNECTOR | | | | M50006020-IIBA R41-9553D | P1090925 | | 1- | A | A4 |
| J 1006 | CONNECTOR | | | | M50-008-020 R41-9553F | P1091132 | | 1- | A | A4 |
| J 1009 | CONNECTOR | | | | SB20-02WS | P0090609 | | 1- | A | A7 |
| J 1010 | CONNECTOR | | | | B7B-ZR(LF)(SN) | P0090649 | | 1- | A | D6 |
| J 1011 | CONNECTOR | | | | HSJ0912-01-041 | P1090749 | | 1- | A | A6 |
| J 1012 | CONNECTOR | | | | HSJ0912-01-040 | P1091129 | | 1- | A | A5 |
| J 1013 | CONNECTOR | | | | SG8035#01 | P1090350 | | 1- | A | A7 |
| J 1016 | CONNECTOR | | | | IL-WX-16SB-VF-B-E1000E | P1091130 | | 1-17 | A | G7 |
| J 1018 | CONNECTOR | | | | SB20-06WS | P0090613 | | 1- | A | H6 |
| J 1019 | CONNECTOR | | | | 9210B-1-03Z172-T | P0091282 | | 1- | | |
| J 1020 | CONNECTOR | | | | 9210B-1-04Z172-T | P0091283 | | 1- | | |
| J 1021 | CONNECTOR | | | | 9210B-1-03Z172-T | P0091282 | | 1- | | |
| J 1021 | CONNECTOR | | | | 9210B-1-04Z172-T | P0091283 | | 18- | | |
| J 1022 | CONNECTOR | | | | 9210B-1-03Z172-T | P0091282 | | 1- | | |
| J 1023 | CONNECTOR | | | | 9210B-1-04Z172-T | P0091283 | | 1- | | |
| J 1024 | CONNECTOR | | | | 9210B-1-04Z172-T | P0091283 | | 1- | | |
| J 1024 | CONNECTOR | | | | 9210B-1-03Z172-T | P0091282 | | 18- | | |
| J 1025 | CONNECTOR | | | | 290A-88-30-335-F | P1091047 | | 1- | A | H7 |
| J 1027 | CONNECTOR | | | | IMSA-9202B-1-03-T | P0091291 | | 18- | A | A2 |
| L 1001 | COIL | | | | E2 0.4-3.0-9.5T-L | L0022575 | | 1- | A | H4 |
| L 1002 | M.RFC | 10uH | | | CDRH74-100MC | L1690599 | | 1- | A | H4 |
| L 1003 | CHIP COIL | 330uH | | | LQH32MN331K23L | L1690105 | | 1- | B | c4 |
| L 1004 | COIL | | | | E2 0.4-3.0-9.5T-L | L0022575 | | 1- | A | G4 |
| L 1005 | M.RFC | 10uH | | | CDRH74-100MC | L1690599 | | 1- | A | G4 |
| L 1006 | M.RFC | 0.022uH | | | HK1608 22NJ-T | L1690520 | | 1- | A | G3 |
| L 1007 | M.RFC | 0.022uH | | | HK1608 22NJ-T | L1690520 | | 1- | A | H3 |
| L 1008 | M.RFC | 0.0027uH | | | HK1608 2N7S-T | L1690509 | | 1- | A | G3 |
| L 1009 | M.RFC | 0.0027uH | | | HK1608 2N7S-T | L1690509 | | 1- | A | G3 |
| L 1010 | M.RFC | 10uH | | | CDRH74-100MC | L1690599 | | 1- | A | G2 |
| L 1011 | COIL | | | | E2 0.3-1.7-7T-R | L0022372 | | 1- | A | G2 |
| L 1012 | M.RFC | 0.039uH | | | HK1608 39NJ-T | L1690523 | | 1- | B | a2 |
| L 1013 | M.RFC | 0.0056uH | | | HK1608 5N6S-T | L1690513 | | 1- | B | b2 |
| L 1014 | M.RFC | 10uH | | | 7B05NB-100M | L1690988 | | 1- | A | F3 |
| L 1014 | M.RFC | 10uH | | | 7E05NB-100M | L1691221 | | 17- | A | F3 |
| L 1015 | COIL | | | | E2 0.25-1.85-8.5T-L | L0022576 | | 1- | A | G3 |
| L 1016 | M.RFC | 0.039uH | | | HK1608 39NJ-T | L1690523 | | 1- | B | b2 |
| L 1016 | M.RFC | 0.022uH | | | HK1608 22NJ-T | L1690520 | | 79- | B | b2 |
| L 1017 | M.RFC | 0.012uH | | | HK1608 12NJ-T | L1690517 | | 1- | B | b2 |
| L 1018 | M.RFC | 4.7uH | | | ELJ-FC4R7KF | L1690348 | | 1- | A | G2 |
| L 1019 | M.RFC | 0.056uH | | | HK1608 56NJ-T | L1690525 | | 1- | B | c2 |
| L 1019 | M.RFC | 0.022uH | | | HK1608 22NJ-T | L1690520 | | 14- | B | c2 |
| L 1020 | M.RFC | 0.068uH | | | HK1608 68NJ-T | L1690526 | | 1- | B | d4 |
| L 1021 | M.RFC | 15uH | | | LAL03TA150K | L1790097 | | 1- | A | F2 |
| L 1023 | M.RFC | 10uH | | | LK1608 100K-T | L1690689 | | 1- | A | F1 |
| L 1024 | M.RFC | 0.015uH | | | HK1608 15NJ-T | L1690518 | | 1- | B | d4 |
| L 1025 | M.RFC | 0.022uH | | | HK1608 22NJ-T | L1690520 | | 1- | B | d4 |
| L 1026 | CHIP COIL | 0.1uH | | | C2520C-R10J | L1690544 | | 1- | B | d1 |
| L 1027 | COIL | | | | E2 0.28-1.0-4T-R | L0022365 | | 1- | A | E1 |
| L 1028 | CHIP COIL | 0.47uH | | | C2520C-R47J | L1690552 | | 1- | B | d1 |
| L 1029 | CHIP COIL | 0.047uH | | | C2520C-47NK | L1690540 | | 1- | B | d1 |
| L 1030 | CHIP COIL | 0.27uH | | | C2520C-R27J | L1690549 | | 1- | B | d1 |
| L 1030 | CHIP COIL | 0.18uH | | | C2520C-R18J | L1690547 | | 7- | B | d1 |
| L 1030 | CHIP COIL | 0.39uH | | 2% | C2520C-R39G | L1691301 | | 79- | B | d1 |
| L 1031 | COIL | | | | E2 0.28-1.0-4T-R | L0022365 | | 1- | A | D1 |
| L 1032 | CHIP COIL | 0.47uH | | | C2520C-R47J | L1690552 | | 1- | B | d1 |
| L 1033 | CHIP COIL | 0.22uH | | | C2520C-R22J | L1690548 | | 1- | B | d1 |
| L 1033 | CHIP COIL | 0.15uH | | | C2520C-R15J | L1690546 | | 7- | B | d1 |
| L 1033 | CHIP COIL | 0.33uH | | 2% | C2520C-R33G | L1691300 | | 79- | B | d1 |
| L 1034 | CHIP COIL | 0.1uH | | | C2520C-R10J | L1690544 | | 1- | B | e1 |
| L 1035 | COIL | | | | E2 0.28-1.0-4T-R | L0022365 | | 1- | A | D1 |
| L 1036 | M.RFC | 0.12uH | | | LK1608 R12K-T | L1690408 | | 1- | B | d3 |
| L 1037 | CHIP COIL | 0.082uH | | | C2520C-82NK | L1690543 | | 1- | A | D1 |
| L 1038 | M.RFC | 0.15uH | | | LK1608 R15K-T | L1690409 | | 1- | B | d3 |
| L 1039 | M.RFC | 4.7uH | | | LK1608 4R7K-T | L1690688 | | 1- | B | h1 |
| L 1040 | CHIP COIL | 0.033uH | | | C2520C-33NK | L1690538 | | 1- | A | F2 |

MAIN Unit

Parts List

| REF | DESCRIPTION | VALUE | V/W | TOL. | MFR'S DESIG | VXSTD P/N | VERS. | LOT | SIDE | LAY ADR |
|--------|-------------|---------|-----|------|---------------------|-----------|-------|-------|------|---------|
| L 1041 | CHIP COIL | 0.33uH | | | C2520C-R33J | L1690550 | | 1- | A | E2 |
| L 1042 | M.RFC | 10uH | | | LK1608 100K-T | L1690689 | | 1- | B | h1 |
| L 1043 | M.RFC | 10uH | | | LK1608 100K-T | L1690689 | | 1- | B | h1 |
| L 1044 | CHIP COIL | 0.033uH | | | C2520C-33NK | L1690538 | | 1- | A | E2 |
| L 1045 | M.RFC | 2.2uH | | | LK1608 2R2K-T | L1690634 | | 1- | B | f3 |
| L 1046 | CHIP COIL | 330uH | | | LQH32MN331K23L | L1690105 | | 1- | A | E3 |
| L 1047 | M.RFC | 0.15uH | | | HK1608 R15J-T | L1690938 | | 1- | B | e2 |
| L 1048 | COIL | | | | E2 0.25-1.85-8.5T-L | L0022576 | | 1- | A | E2 |
| L 1049 | COIL 05RF | | | | 2.7UH 020812327 | L0022833 | | 1- | A | C3 |
| L 1050 | M.RFC | 10uH | | | LK1608 100K-T | L1690689 | | 1- | B | h2 |
| L 1051 | M.RFC | 10uH | | | LK1608 100K-T | L1690689 | | 1- | B | h2 |
| L 1052 | M.RFC | 10uH | | | LK1608 100K-T | L1690689 | | 1- | A | C3 |
| L 1053 | M.RFC | 10uH | | | LK1608 100K-T | L1690689 | | 1- | A | D3 |
| L 1054 | M.RFC | 470uH | | | FLC32T-471J | L1690235 | | 1- | B | e5 |
| L 1055 | M.RFC | 470uH | | | FLC32T-471J | L1690235 | | 1- | A | B4 |
| L 1056 | M.RFC | 470uH | | | FLC32T-471J | L1690235 | | 1- | B | g5 |
| L 1057 | CHIP COIL | 10uH | | | C2520F-100K | L1690596 | | 18- | B | b4 |
| L 1057 | CHIP COIL | 10uH | | 5% | NLV-25T-100J-PF | L1691436 | | 62- | B | b4 |
| L 1058 | CHIP COIL | 10uH | | 5% | C2520F-100K | L1690596 | | 18- | B | b4 |
| L 1058 | CHIP COIL | 10uH | | 5% | NLV-25T-100J-PF | L1691436 | | 62- | B | b4 |
| L 1059 | CHIP COIL | 10uH | | | C2520F-100K | L1690596 | | 18- | B | b4 |
| L 1059 | CHIP COIL | 10uH | | 5% | NLV-25T-100J-PF | L1691436 | | 62-72 | B | b4 |
| L 1059 | CHIP COIL | 0.01uH | | 2% | C2520C-10NG | L1691283 | | 75- | B | b4 |
| L 1060 | M.RFC | 470uH | | | FLC32T-471J | L1690235 | | 1- | B | f4 |
| L 1061 | M.RFC | 22uH | | | LK2125 220M-T | L1690335 | | 1- | A | H5 |
| L 1062 | M.RFC | 22uH | | | LK2125 220M-T | L1690335 | | 1- | A | H5 |
| L 1063 | M.RFC | 22uH | | | LK2125 220M-T | L1690335 | | 1- | A | H5 |
| L 1064 | M.RFC | 22uH | | | LK2125 220M-T | L1690335 | | 1- | A | H6 |
| L 1065 | M.RFC | 22uH | | | LK2125 220M-T | L1690335 | | 1- | A | H6 |
| L 1066 | M.RFC | 22uH | | | LK2125 220M-T | L1690335 | | 1- | A | H6 |
| L 1067 | COIL | | | | E2 0.26-0.9-3T-R | L0022367 | | 1- | A | F2 |
| L 1068 | COIL | | | | E2 0.28-1.0-4T-R | L0022365 | | 1- | A | F2 |
| L 1069 | M.RFC | 0.015uH | | | HK1608 15NJ-T | L1690518 | W/ CE | 3-17 | A | E1 |
| L 1069 | M.RFC | 0.015uH | | | HK1608 15NJ-T | L1690518 | | 18- | A | E1 |
| P 1001 | CONNECTOR | | | | IMSA-9206H-T | P1090988 | | 1- | | |
| P 1002 | CONNECTOR | | | | IMSA-9206H-T | P1090988 | | 18- | | |
| Q 1001 | FET | | | | 2SK2975-T11 | G3829757 | | 1- | A | G3 |
| Q 1001 | FET | | | | RD07MVS1-T12 | G3070320 | | 14- | A | G3 |
| Q 1002 | FET | | | | 2SK2975-T11 | G3829757 | | 1- | A | H3 |
| Q 1002 | FET | | | | RD07MVS1-T12 | G3070320 | | 14- | A | H3 |
| Q 1003 | IC | | | | BU4094BCFV-E2 | G1093527 | | 1- | A | E4 |
| Q 1003 | IC | | | | CD4094BPWR | G1093866 | | 17- | A | E4 |
| Q 1004 | IC | | | | BU4094BCFV-E2 | G1093527 | | 1- | A | E4 |
| Q 1004 | IC | | | | CD4094BPWR | G1093866 | | 17- | A | E4 |
| Q 1005 | TRANSISTOR | | | | 2SC4154-T11-1E | G3341548E | | 1- | B | b2 |
| Q 1006 | FET | | | | 2SK2973-T13 | G3829738 | | 1- | A | G2 |
| Q 1006 | FET | | | | RD01MUS1-T113 | G3070321 | | 14- | A | G2 |
| Q 1007 | FET | | | | 2SK2973-T13 | G3829738 | | 1- | A | G2 |
| Q 1007 | FET | | | | RD01MUS1-T113 | G3070321 | | 14- | A | G2 |
| Q 1008 | TRANSISTOR | | | | 2SC4154-T11-1E | G3341548E | | 1- | B | b2 |
| Q 1009 | TRANSISTOR | | | | 2SC4154-T11-1E | G3341548E | | 1- | B | a1 |
| Q 1010 | IC | | | | BU4094BCFV-E2 | G1093527 | | 1- | A | D4 |
| Q 1010 | IC | | | | CD4094BPWR | G1093866 | | 17- | A | D4 |
| Q 1011 | FET | | | | 2SK2596BXTL | G3825967 | | 1- | B | b2 |
| Q 1012 | TRANSISTOR | | | | 2SC4154-T11-1E | G3341548E | | 1- | B | a1 |
| Q 1013 | TRANSISTOR | | | | 2SB624-T2B BV3 | G3206247C | | 1- | A | F1 |
| Q 1014 | IC | | | | KIA7808API | G1093164 | | 1- | A | F1 |
| Q 1015 | TRANSISTOR | | | | FMG5 T148 | G3070021 | | 1- | A | G1 |
| Q 1016 | IC | | | | M62352GP-70EC | G1092689 | | 1- | A | E4 |
| Q 1017 | TRANSISTOR | | | | 2SC3357-T2 | G3333577 | | 1- | B | b2 |
| Q 1018 | TRANSISTOR | | | | UMC5N TR | G3070137 | | 1- | A | F1 |
| Q 1019 | IC | | | | BA05FP-E2 | G1093209 | | 1- | B | b1 |
| Q 1020 | TRANSISTOR | | | | 2SB624-T2B BV3 | G3206247C | | 1- | A | F1 |
| Q 1021 | TRANSISTOR | | | | RT1N241M-T11-1 | G3070249 | | 1- | B | c3 |
| Q 1022 | IC | | | | UPC2710T-E3 | G1091844 | | 1- | B | c1 |
| Q 1022 | IC | | | | UPC2710TB-E3 | G1093932 | | 18- | B | c1 |
| Q 1023 | IC | | | | BB304CDW-TL | G1093324 | | 1- | B | d3 |
| Q 1024 | IC | | | | BB304CDW-TL | G1093324 | | 1- | B | c3 |
| Q 1025 | TRANSISTOR | | | | 2SC5374-TL | G3353748 | | 1- | B | d3 |
| Q 1026 | FET | | | | 2SK2685ZT-TR | G3826857 | | 1- | B | d4 |
| Q 1026 | FET | | | | NE34018-T1 | G3070328 | | 18- | B | d4 |
| Q 1027 | TRANSISTOR | | | | UMH6N TR | G3070216 | | 1- | B | d3 |
| Q 1028 | IC | | | | BA05FP-E2 | G1093209 | | 1- | B | c7 |

MAIN Unit

Parts List

| REF | DESCRIPTION | VALUE | V/W | TOL. | MFR'S DESIG | VXSTD P/N | VERS. | LOT | SIDE | LAY ADR |
|--------|-------------|-------|-----|------|-------------------|-----------|-------|-----|------|---------|
| Q 1029 | TRANSISTOR | | | | UMD2N TR | G3070076 | | 1- | B | d3 |
| Q 1030 | IC | | | | PST3445UR | G1093232 | | 1- | B | b7 |
| Q 1031 | FET | | | | 2SJ355-T1 | G3703558 | | 1- | B | c6 |
| Q 1032 | TRANSISTOR | | | | RT1N241M-T11-1 | G3070249 | | 1- | B | c6 |
| Q 1033 | TRANSISTOR | | | | UMC5N TR | G3070137 | | 1- | B | c3 |
| Q 1034 | TRANSISTOR | | | | UMC5N TR | G3070137 | | 1- | B | c3 |
| Q 1035 | TRANSISTOR | | | | RT1N241M-T11-1 | G3070249 | | 1- | B | c6 |
| Q 1036 | TRANSISTOR | | | | 2SA1602A-T11-1F | G3116028F | | 1- | A | F7 |
| Q 1036 | TRANSISTOR | | | | ISA1602AM1 | G3070380 | | 79- | A | F7 |
| Q 1037 | TRANSISTOR | | | | 2SC4154-T11-1E | G3341548E | | 1- | A | F7 |
| Q 1038 | IC | | | | TC4W53FU(TE12L_F) | G1091675 | | 1- | A | E6 |
| Q 1039 | TRANSISTOR | | | | 2SC4154-T11-1E | G3341548E | | 1- | B | b6 |
| Q 1040 | TRANSISTOR | | | | 2SA1602A-T11-1F | G3116028F | | 1- | B | b6 |
| Q 1040 | TRANSISTOR | | | | ISA1602AM1 | G3070380 | | 79- | B | b6 |
| Q 1041 | TRANSISTOR | | | | 2SC4400-3-TL | G3344008C | | 1- | B | f3 |
| Q 1042 | TRANSISTOR | | | | 2SC4154-T11-1E | G3341548E | | 1- | B | f3 |
| Q 1043 | TRANSISTOR | | | | 2SC4400-3-TL | G3344008C | | 1- | B | h1 |
| Q 1044 | TRANSISTOR | | | | 2SC4154-T11-1E | G3341548E | | 1- | B | f3 |
| Q 1045 | TRANSISTOR | | | | 2SC4154-T11-1E | G3341548E | | 1- | B | f3 |
| Q 1046 | TRANSISTOR | | | | 2SC4400-3-TL | G3344008C | | 1- | B | h1 |
| Q 1047 | TRANSISTOR | | | | RT1N241M-T11-1 | G3070249 | | 1- | A | E5 |
| Q 1048 | TRANSISTOR | | | | 2SC4400-3-TL | G3344008C | | 1- | B | h1 |
| Q 1049 | IC | | | | HD64F2134FA20 | ✳ | | 1- | A | F5 |
| Q 1050 | TRANSISTOR | | | | 2SA1602A-T11-1F | G3116028F | | 1- | B | f3 |
| Q 1050 | TRANSISTOR | | | | ISA1602AM1 | G3070380 | | 79- | B | f3 |
| Q 1051 | TRANSISTOR | | | | 2SC4400-3-TL | G3344008C | | 1- | B | f3 |
| Q 1052 | TRANSISTOR | | | | 2SC4400-3-TL | G3344008C | | 1- | B | g3 |
| Q 1053 | TRANSISTOR | | | | DTC114EUA T106 | G3070084 | | 1- | A | F5 |
| Q 1054 | TRANSISTOR | | | | 2SC4154-T11-1E | G3341548E | | 1- | B | c1 |
| Q 1055 | TRANSISTOR | | | | 2SC4154-T11-1E | G3341548E | | 1- | B | e2 |
| Q 1056 | TRANSISTOR | | | | 2SC4400-3-TL | G3344008C | | 1- | B | f3 |
| Q 1057 | TRANSISTOR | | | | 2SC4154-T11-1E | G3341548E | | 1- | A | C3 |
| Q 1058 | IC | | | | CXA1611N-T4 | G1092695 | | 1- | B | c2 |
| Q 1059 | TRANSISTOR | | | | 2SC4400-3-TL | G3344008C | | 1- | B | h2 |
| Q 1060 | TRANSISTOR | | | | UMC5N TR | G3070137 | | 1- | A | C3 |
| Q 1061 | IC | | | | BB304CDW-TL | G1093324 | | 1- | B | e2 |
| Q 1061 | IC | | | | BB301CAW-TL | G1093186 | | 18- | B | e2 |
| Q 1062 | IC | | | | AD9835BRUZ-REEL7 | G1093142 | | 1- | B | h2 |
| Q 1063 | TRANSISTOR | | | | UMC5N TR | G3070137 | | 1- | B | c2 |
| Q 1064 | TRANSISTOR | | | | 2SC4154-T11-1E | G3341548E | | 1- | A | D2 |
| Q 1065 | IC | | | | 24LC128T-I/SN | G1093668 | | 1- | A | F4 |
| Q 1066 | IC | | | | BU4053BCFV-E2 | G1093422 | | 1- | B | d5 |
| Q 1066 | IC | | | | CD4053BPWR | G1093864 | | 17- | B | d5 |
| Q 1067 | IC | | | | TC4W53FU(TE12L_F) | G1091675 | | 1- | B | d5 |
| Q 1068 | TRANSISTOR | | | | 2SC4154-T11-1E | G3341548E | | 1- | B | f4 |
| Q 1069 | TRANSISTOR | | | | 2SC4154-T11-1E | G3341548E | | 1- | A | B4 |
| Q 1070 | TRANSISTOR | | | | 2SC4154-T11-1E | G3341548E | | 1- | B | g3 |
| Q 1071 | IC | | | | SA602AD/01.118 | G1093612 | | 1- | A | B4 |
| Q 1073 | IC | | | | BB305CEW-TL | G1093677 | | 1- | B | e4 |
| Q 1073 | IC | | | | BB301CAW-TL | G1093186 | | 18- | B | e4 |
| Q 1074 | TRANSISTOR | | | | 2SC4154-T11-1E | G3341548E | | 1- | B | h5 |
| Q 1075 | IC | | | | BB305CEW-TL | G1093677 | | 1- | B | e5 |
| Q 1076 | TRANSISTOR | | | | 2SC4154-T11-1E | G3341548E | | 1- | B | g4 |
| Q 1077 | TRANSISTOR | | | | 2SC4154-T11-1E | G3341548E | | 1- | A | D5 |
| Q 1078 | TRANSISTOR | | | | 2SC4154-T11-1E | G3341548E | | 1- | B | h6 |
| Q 1079 | IC | | | | BB305CEW-TL | G1093677 | | 1- | B | e5 |
| Q 1080 | IC | | | | TA31136FNG(EL) | G1091605 | | 1- | B | g5 |
| Q 1081 | IC | | | | BB305CEW-TL | G1093677 | | 1- | B | g5 |
| Q 1081 | IC | | | | BB301CAW-TL | G1093186 | | 18- | B | g5 |
| Q 1082 | IC | | | | SA602AD/01.118 | G1093612 | | 1- | A | C4 |
| Q 1083 | FET | | | | 2SK302Y(TE85R.F) | G3803027Y | | 1- | B | f4 |
| Q 1084 | FET | | | | 2SK302Y(TE85R.F) | G3803027Y | | 1- | B | f5 |
| Q 1085 | TRANSISTOR | | | | 2SC4154-T11-1E | G3341548E | | 1- | A | D5 |
| Q 1086 | TRANSISTOR | | | | RT1N241M-T11-1 | G3070249 | | 1- | A | B5 |
| Q 1087 | IC | | | | M62364FP 600D | G1093033 | | 1- | B | g3 |
| Q 1088 | IC | | | | BB305CEW-TL | G1093677 | | 1- | B | g5 |
| Q 1088 | IC | | | | BB301CAW-TL | G1093186 | | 18- | B | g5 |
| Q 1089 | IC | | | | BB304CDW-TL | G1093324 | | 1- | B | f4 |
| Q 1090 | TRANSISTOR | | | | 2SC4154-T11-1E | G3341548E | | 1- | A | B5 |
| Q 1091 | TRANSISTOR | | | | RT1N241M-T11-1 | G3070249 | | 1- | B | g5 |
| Q 1092 | IC | | | | AK7712AVT | G1093815 | | 18- | B | b5 |
| Q 1093 | TRANSISTOR | | | | 2SC4154-T11-1E | G3341548E | | 1- | A | D6 |
| Q 1094 | TRANSISTOR | | | | 2SC4154-T11-1E | G3341548E | | 1- | B | g6 |

✳ Please contact VERTEX STANDARD.

MAIN Unit

Parts List

| REF | DESCRIPTION | VALUE | V/W | TOL. | MFR'S DESIG | VXSTD P/N | VERS. | LOT | SIDE | LAY ADR |
|--------|-------------|-------|-------|------|-------------------|-----------|-------|------|------|---------|
| Q 1095 | IC | | | | TA75S01F(TE85R.F) | G1091593 | | 1- | A | A4 |
| Q 1096 | TRANSISTOR | | | | 2SC4154-T11-1E | G3341548E | | 1- | B | f5 |
| Q 1097 | TRANSISTOR | | | | 2SC4154-T11-1E | G3341548E | | 1- | B | e6 |
| Q 1098 | IC | | | | TC4W53FU(TE12L_F) | G1091675 | | 1- | B | g3 |
| Q 1099 | TRANSISTOR | | | | 2SA1602A-T11-1F | G3116028F | | 1- | B | e6 |
| Q 1099 | TRANSISTOR | | | | ISA1602AM1 | G3070380 | | 79- | B | e6 |
| Q 1100 | IC | | | | TC4S66F(TE85R.F) | G1090893 | | 1- | A | A4 |
| Q 1102 | TRANSISTOR | | | | DTC114EUA T106 | G3070084 | | 18- | B | b5 |
| Q 1103 | IC | | | | M51132FP 600C | G1091930 | | 1- | B | d6 |
| Q 1104 | TRANSISTOR | | | | FMG5 T148 | G3070021 | | 1- | B | g6 |
| Q 1105 | IC | | | | TDA2003H | G1090815 | | 1- | A | E7 |
| Q 1106 | TRANSISTOR | | | | FMG5 T148 | G3070021 | | 1- | B | g6 |
| Q 1107 | TRANSISTOR | | | | RT1N241M-T11-1 | G3070249 | | 1- | B | g6 |
| Q 1108 | TRANSISTOR | | | | 2SD2211 T100 QR | G3422117Q | | 1- | B | h3 |
| Q 1109 | TRANSISTOR | | | | 2SC4154-T11-1E | G3341548E | | 1- | B | b6 |
| Q 1110 | TRANSISTOR | | | | DTC114EUA T106 | G3070084 | | 1- | B | d6 |
| Q 1111 | IC | | | | NJM2902V-TE1 | G1091679 | | 1- | B | b1 |
| Q 1112 | IC | | | | NJM2904V-TE1 | G1091677 | | 1- | B | a1 |
| Q 1113 | IC | | | | BU4011BF-E2 | G1092724 | | 1- | A | G5 |
| Q 1114 | IC | | | | NJM2902V-TE1 | G1091679 | | 1- | A | E5 |
| Q 1115 | IC | | | | NJM2902V-TE1 | G1091679 | | 18- | B | c5 |
| Q 1116 | IC | | | | NJM2902V-TE1 | G1091679 | | 18- | B | c5 |
| Q 1117 | IC | | | | NJM2904V-TE1 | G1091677 | | 1- | B | e4 |
| Q 1118 | IC | | | | NJM2902V-TE1 | G1091679 | | 1- | B | g3 |
| Q 1119 | IC | | | | NJM2902V-TE1 | G1091679 | | 1- | B | g3 |
| Q 1120 | IC | | | | NJM2902V-TE1 | G1091679 | | 1- | A | B3 |
| Q 1121 | IC | | | | BU4066BCFV-E2 | G1093537 | | 1- | A | B3 |
| Q 1121 | IC | | | | CD4066BPWR | G1093865 | | 17- | A | B3 |
| Q 1122 | IC | | | | BU4066BCFV-E2 | G1093537 | | 1- | A | B3 |
| Q 1122 | IC | | | | BU4066BCFV-E2 | G1093537 | | 17- | A | B3 |
| Q 1123 | IC | | | | NJM2904V-TE1 | G1091677 | | 1- | B | g4 |
| Q 1124 | TRANSISTOR | | | | UMH6N TR | G3070216 | | 1- | A | D6 |
| Q 1125 | TRANSISTOR | | | | UMH6N TR | G3070216 | | 1- | B | e6 |
| Q 1126 | TRANSISTOR | | | | UMH6N TR | G3070216 | | 1- | B | g6 |
| Q 1128 | IC | | | | SPM5001-TL-E | G1093686 | | 1- | A | D2 |
| Q 1129 | IC | | | | TC4S81F(TE85R.F) | G1090895 | | 1- | A | G6 |
| R 1001 | CHIP RES. | 470 | 1/16W | 5% | RMC1/16S 471JTH | J24189021 | | 1- | B | a1 |
| R 1002 | CHIP RES. | 470 | 1/16W | 5% | RMC1/16S 471JTH | J24189021 | | 1- | B | a1 |
| R 1003 | CHIP RES. | 470 | 1/16W | 5% | RMC1/16S 471JTH | J24189021 | | 1- | B | a1 |
| R 1004 | CHIP RES. | 470 | 1/16W | 5% | RMC1/16S 471JTH | J24189021 | | 1- | B | b1 |
| R 1005 | CHIP RES. | 470 | 1/16W | 5% | RMC1/16S 471JTH | J24189021 | | 1- | B | b1 |
| R 1006 | CHIP RES. | 470 | 1/16W | 5% | RMC1/16S 471JTH | J24189021 | | 1- | A | G1 |
| R 1007 | CHIP RES. | 470 | 1/16W | 5% | RMC1/16S 471JTH | J24189021 | | 1- | A | G1 |
| R 1008 | CHIP RES. | 470 | 1/16W | 5% | RMC1/16S 471JTH | J24189021 | | 1- | A | G1 |
| R 1010 | CHIP RES. | 470 | 1W | 5% | RMC1 471JTE | J24305471 | | 1- | B | a4 |
| R 1011 | CHIP RES. | 470 | 1W | 5% | RMC1 471JTE | J24305471 | | 1- | B | b4 |
| R 1012 | CHIP RES. | 470 | 1/16W | 5% | RMC1/16S 471JTH | J24189021 | | 1- | B | c4 |
| R 1013 | CHIP RES. | 220 | 1W | 5% | RMC1 221JTE | J24305221 | | 1- | A | G3 |
| R 1014 | CHIP RES. | 220 | 1W | 5% | RMC1 221JTE | J24305221 | | 1- | A | H3 |
| R 1015 | CHIP RES. | 330 | 1/16W | 5% | RMC1/16 331JATP | J24185331 | | 1- | A | F3 |
| R 1015 | CHIP RES. | 820 | 1/16W | 5% | RMC1/16 821JATP | J24185821 | | 14- | A | F3 |
| R 1016 | CHIP RES. | 56 | 1/16W | 5% | RMC1/16 560JATP | J24185560 | | 1- | A | G3 |
| R 1017 | CHIP RES. | 220 | 1/16W | 5% | RMC1/16 221JATP | J24185221 | | 1- | A | G3 |
| R 1017 | CHIP RES. | 470 | 1/16W | 5% | RMC1/16 471JATP | J24185471 | | 14- | A | G3 |
| R 1018 | CHIP RES. | 100k | 1/16W | 5% | RMC1/16S 104JTH | J24189049 | | 1- | B | b1 |
| R 1019 | CHIP RES. | 100k | 1/16W | 5% | RMC1/16S 104JTH | J24189049 | | 1- | B | a1 |
| R 1020 | CHIP RES. | 330 | 1/16W | 5% | RMC1/16 331JATP | J24185331 | | 1- | A | H3 |
| R 1020 | CHIP RES. | 820 | 1/16W | 5% | RMC1/16 821JATP | J24185821 | | 14- | A | H3 |
| R 1021 | CHIP RES. | 56 | 1/16W | 5% | RMC1/16 560JATP | J24185560 | | 1- | A | H3 |
| R 1022 | CHIP RES. | 220 | 1/16W | 5% | RMC1/16 221JATP | J24185221 | | 1- | A | G3 |
| R 1022 | CHIP RES. | 470 | 1/16W | 5% | RMC1/16 471JATP | J24185471 | | 14- | A | G3 |
| R 1023 | CHIP RES. | 470 | 1/16W | 5% | RMC1/16S 471JTH | J24189021 | | 1- | A | E5 |
| R 1024 | CHIP RES. | 470 | 1/16W | 5% | RMC1/16S 471JTH | J24189021 | | 1- | A | E5 |
| R 1025 | CHIP RES. | 10k | 1/16W | 5% | RMC1/16S 103JTH | J24189037 | | 1- | B | b1 |
| R 1026 | CHIP RES. | 47k | 1/16W | 5% | RMC1/16S 473JTH | J24189045 | | 1- | B | b1 |
| R 1027 | CHIP RES. | 2.2M | 1/16W | 5% | RMC1/16S 225JTH | J24189065 | | 1- | B | b1 |
| R 1028 | CHIP RES. | 100k | 1/16W | 5% | RMC1/16S 104JTH | J24189049 | | 1- | B | b2 |
| R 1029 | CHIP RES. | 68k | 1/16W | 5% | RMC1/16S 683JTH | J24189047 | | 1-78 | B | b2 |
| R 1031 | CHIP RES. | 470 | 1/2W | 5% | RMC1/2 471JCTP | J24275471 | | 1- | B | b2 |
| R 1032 | CHIP RES. | 4.7k | 1/16W | 5% | RMC1/16S 472JTH | J24189033 | | 1- | B | a2 |
| R 1033 | CHIP RES. | 220 | 1/4W | 5% | RMC1/4 221JATP | J24245221 | | 1- | B | a2 |
| R 1034 | CHIP RES. | 100k | 1/16W | 5% | RMC1/16S 104JTH | J24189049 | | 1- | B | b2 |
| R 1035 | CHIP RES. | 2.7k | 1/16W | 5% | RMC1/16S 272JTH | J24189030 | | 1- | A | F2 |

MAIN Unit

Parts List

| REF | DESCRIPTION | VALUE | V/W | TOL. | MFR'S DESIG | VXSTD P/N | VERS. | LOT | SIDE | LAY ADR |
|--------|-------------|-------|-------|------|-----------------|-----------|-------|-----|------|---------|
| R 1035 | CHIP RES. | 1.5k | 1/16W | 5% | RMC1/16S 152JTH | J24189027 | | 14- | A | F2 |
| R 1036 | CHIP RES. | 10k | 1/16W | 5% | RMC1/16S 103JTH | J24189037 | | 1- | B | b2 |
| R 1037 | CHIP RES. | 470 | 1/16W | 5% | RMC1/16S 471JTH | J24189021 | | 1- | A | E5 |
| R 1038 | CHIP RES. | 10 | 1/16W | 5% | RMC1/16 100JATP | J24185100 | | 1- | A | G2 |
| R 1039 | CHIP RES. | 10 | 1/16W | 5% | RMC1/16 100JATP | J24185100 | | 1- | A | G2 |
| R 1041 | CHIP RES. | 56 | 1/16W | 5% | RMC1/16 560JATP | J24185560 | | 1- | A | G2 |
| R 1042 | CHIP RES. | 1k | 1/16W | 5% | RMC1/16 102JATP | J24185102 | | 1- | A | G2 |
| R 1043 | CHIP RES. | 4.7k | 1/16W | 5% | RMC1/16S 472JTH | J24189033 | | 1- | B | b2 |
| R 1044 | CHIP RES. | 2.2M | 1/16W | 5% | RMC1/16S 225JTH | J24189065 | | 1- | B | b2 |
| R 1045 | CHIP RES. | 10 | 1/16W | 5% | RMC1/16S 100JTH | J24189001 | | 1- | B | a2 |
| R 1046 | CHIP RES. | 2.2k | 1/16W | 5% | RMC1/16S 222JTH | J24189029 | | 1- | B | a2 |
| R 1047 | CHIP RES. | 10k | 1/16W | 5% | RMC1/16S 103JTH | J24189037 | | 1-3 | B | a2 |
| R 1048 | CHIP RES. | 270 | 1/16W | 5% | RMC1/16 271JATP | J24185271 | | 1- | B | b3 |
| R 1048 | CHIP RES. | 68 | 1/16W | 5% | RMC1/16 680JATP | J24185680 | | 79- | B | b3 |
| R 1049 | CHIP RES. | 330 | 1/16W | 5% | RMC1/16S 331JTH | J24189019 | | 1- | B | b1 |
| R 1049 | CHIP RES. | 3.3k | 1/16W | 5% | RMC1/16S 332JTH | J24189031 | | 4- | B | b1 |
| R 1050 | CHIP RES. | 470 | 1/10W | 5% | RMC1/10T 471J | J24205471 | | 1- | B | b3 |
| R 1051 | CHIP RES. | 470k | 1/16W | 5% | RMC1/16S 474JTH | J24189057 | | 1- | B | a2 |
| R 1052 | CHIP RES. | 1.8k | 1/16W | 5% | RMC1/16S 182JTH | J24189028 | | 1- | A | F2 |
| R 1052 | CHIP RES. | 1.2k | 1/16W | 5% | RMC1/16S 122JTH | J24189026 | | 13- | A | F2 |
| R 1053 | CHIP RES. | 100 | 1/16W | 5% | RMC1/16 101JATP | J24185101 | | 1- | A | F2 |
| R 1054 | CHIP RES. | 470 | 1/16W | 5% | RMC1/16 471JATP | J24185471 | | 1- | B | b2 |
| R 1054 | CHIP RES. | 330 | 1/16W | 5% | RMC1/16 331JATP | J24185331 | | 13- | B | b2 |
| R 1057 | CHIP RES. | 3.3k | 1/16W | 5% | RMC1/16S 332JTH | J24189031 | | 1- | A | F1 |
| R 1058 | CHIP RES. | 10k | 1/16W | 5% | RMC1/16S 103JTH | J24189037 | | 1- | B | a1 |
| R 1059 | CHIP RES. | 47k | 1/16W | 5% | RMC1/16S 473JTH | J24189045 | | 1- | B | a1 |
| R 1060 | CHIP RES. | 3.3k | 1/16W | 5% | RMC1/16S 332JTH | J24189031 | | 1- | B | a1 |
| R 1061 | CHIP RES. | 100 | 1/16W | 5% | RMC1/16 101JATP | J24185101 | | 1- | A | G2 |
| R 1062 | CHIP RES. | 56 | 1/16W | 5% | RMC1/16 560JATP | J24185560 | | 1- | B | b2 |
| R 1062 | CHIP RES. | 100 | 1/16W | 5% | RMC1/16 101JATP | J24185101 | | 29- | B | b2 |
| R 1063 | CHIP RES. | 10k | 1/16W | 5% | RMC1/16S 103JTH | J24189037 | | 1- | B | a1 |
| R 1064 | CHIP RES. | 390 | 1/16W | 5% | RMC1/16S 391JTH | J24189020 | | 1- | A | E4 |
| R 1065 | CHIP RES. | 100 | 1/16W | 5% | RMC1/16 101JATP | J24185101 | | 1- | B | b2 |
| R 1066 | CHIP RES. | 4.7k | 1/16W | 5% | RMC1/16S 472JTH | J24189033 | | 1- | A | E5 |
| R 1066 | CHIP RES. | 1k | 1/16W | 5% | RMC1/16S 102JTH | J24189025 | | 18- | A | E5 |
| R 1067 | CHIP RES. | 47k | 1/16W | 5% | RMC1/16S 473JTH | J24189045 | | 1- | B | a1 |
| R 1068 | CHIP RES. | 470 | 1/16W | 5% | RMC1/16S 471JTH | J24189021 | | 1- | A | E5 |
| R 1069 | CHIP RES. | 10k | 1/16W | 5% | RMC1/16S 103JTH | J24189037 | | 1- | B | a1 |
| R 1070 | CHIP RES. | 0 | 1/16W | 5% | RMC1/16 000JATP | J24185000 | | 1- | A | F2 |
| R 1070 | CHIP RES. | 2.2k | 1/16W | 5% | RMC1/16 222JATP | J24185222 | | 4- | A | F2 |
| R 1071 | CHIP RES. | 1.8k | 1/16W | 5% | RMC1/16 182JATP | J24185182 | | 1- | B | c2 |
| R 1072 | CHIP RES. | 1.8k | 1/16W | 5% | RMC1/16 182JATP | J24185182 | | 1- | B | b2 |
| R 1073 | CHIP RES. | 10k | 1/16W | 5% | RMC1/16S 103JTH | J24189037 | | 1- | B | a1 |
| R 1074 | CHIP RES. | 470 | 1/16W | 5% | RMC1/16S 471JTH | J24189021 | | 1- | A | E5 |
| R 1075 | CHIP RES. | 1k | 1/16W | 5% | RMC1/16S 102JTH | J24189025 | | 1- | A | F1 |
| R 1076 | CHIP RES. | 10k | 1/16W | 5% | RMC1/16S 103JTH | J24189037 | | 1- | A | E4 |
| R 1077 | CHIP RES. | 470 | 1/16W | 5% | RMC1/16S 471JTH | J24189021 | | 1- | A | E5 |
| R 1078 | CHIP RES. | 10k | 1/16W | 5% | RMC1/16S 103JTH | J24189037 | | 1- | A | E2 |
| R 1079 | CHIP RES. | 220k | 1/16W | 5% | RMC1/16S 224JTH | J24189053 | | 1- | B | a1 |
| R 1080 | CHIP RES. | 120 | 1/16W | 5% | RMC1/16 121JATP | J24185121 | | 1- | B | c2 |
| R 1080 | CHIP RES. | 82 | 1/16W | 5% | RMC1/16 820JATP | J24185820 | | 79- | B | c2 |
| R 1082 | CHIP RES. | 100k | 1/16W | 5% | RMC1/16S 104JTH | J24189049 | | 1- | B | d3 |
| R 1083 | CHIP RES. | 2.2k | 1/16W | 5% | RMC1/16S 222JTH | J24189029 | | 1- | B | d4 |
| R 1084 | CHIP RES. | 47k | 1/16W | 5% | RMC1/16S 473JTH | J24189045 | | 1- | B | a1 |
| R 1085 | CHIP RES. | 470 | 1/16W | 5% | RMC1/16S 471JTH | J24189021 | | 1- | B | d4 |
| R 1086 | CHIP RES. | 1k | 1/16W | 5% | RMC1/16S 102JTH | J24189025 | | 1- | A | E3 |
| R 1087 | CHIP RES. | 1k | 1/16W | 5% | RMC1/16S 102JTH | J24189025 | | 1- | A | E4 |
| R 1088 | CHIP RES. | 56 | 1/16W | 5% | RMC1/16 560JATP | J24185560 | | 1- | B | c2 |
| R 1088 | CHIP RES. | 100 | 1/16W | 5% | RMC1/16 101JATP | J24185101 | | 79- | B | c2 |
| R 1089 | CHIP RES. | 1k | 1/16W | 5% | RMC1/16S 102JTH | J24189025 | | 1- | B | d3 |
| R 1090 | CHIP RES. | 330 | 1/16W | 5% | RMC1/16 331JATP | J24185331 | | 1- | B | c1 |
| R 1091 | CHIP RES. | 0 | 1/16W | 5% | RMC1/16S JP TH | J24189070 | | 1- | B | a1 |
| R 1092 | CHIP RES. | 1k | 1/16W | 5% | RMC1/16S 102JTH | J24189025 | | 1- | B | d4 |
| R 1093 | CHIP RES. | 22k | 1/16W | 5% | RMC1/16S 223JTH | J24189041 | | 1- | B | a1 |
| R 1094 | CHIP RES. | 10k | 1/16W | 5% | RMC1/16S 103JTH | J24189037 | | 1- | A | E6 |
| R 1095 | CHIP RES. | 120 | 1/16W | 5% | RMC1/16 121JATP | J24185121 | | 1- | B | c2 |
| R 1095 | CHIP RES. | 82 | 1/16W | 5% | RMC1/16 820JATP | J24185820 | | 79- | B | c2 |
| R 1096 | CHIP RES. | 10 | 1/16W | 5% | RMC1/16S 100JTH | J24189001 | | 1- | A | E4 |
| R 1097 | CHIP RES. | 27k | 1/16W | 5% | RMC1/16S 273JTH | J24189042 | | 1- | A | E6 |
| R 1098 | CHIP RES. | 470 | 1/16W | 5% | RMC1/16S 471JTH | J24189021 | | 1- | B | d3 |
| R 1098 | CHIP RES. | 100 | 1/16W | 5% | RMC1/16S 101JTH | J24189013 | | 57- | B | d3 |
| R 1099 | CHIP RES. | 470k | 1/16W | 5% | RMC1/16S 474JTH | J24189057 | | 1- | B | d3 |
| R 1100 | CHIP RES. | 470k | 1/16W | 5% | RMC1/16S 474JTH | J24189057 | | 1- | B | c3 |

MAIN Unit

Parts List

| REF | DESCRIPTION | VALUE | V/W | TOL. | MFR'S DESIG | VXSTD P/N | VERS. | LOT | SIDE | LAY ADR |
|--------|-------------|-------|-------|------|-----------------|-----------|-------|------|------|---------|
| R 1101 | CHIP RES. | 27 | 1/16W | 5% | RMC1/16S 270JTH | J24189006 | | 1- | B | d3 |
| R 1103 | CHIP RES. | 120 | 1/16W | 5% | RMC1/16S 121JTH | J24189014 | | 1- | A | F1 |
| R 1104 | CHIP RES. | 680k | 1/16W | 5% | RMC1/16S 684JTH | J24189059 | | 1- | B | c3 |
| R 1105 | CHIP RES. | 680k | 1/16W | 5% | RMC1/16S 684JTH | J24189059 | | 1- | B | c3 |
| R 1106 | CHIP RES. | 100k | 1/16W | 5% | RMC1/16S 104JTH | J24189049 | | 1- | B | c3 |
| R 1107 | CHIP RES. | 100k | 1/16W | 5% | RMC1/16S 104JTH | J24189049 | | 1- | B | c3 |
| R 1108 | CHIP RES. | 33 | 1/16W | 5% | RMC1/16S 330JTH | J24189007 | | 1- | B | d3 |
| R 1109 | CHIP RES. | 27 | 1/16W | 5% | RMC1/16S 270JTH | J24189006 | | 1- | B | d3 |
| R 1110 | CHIP RES. | 1k | 1/16W | 5% | RMC1/16S 102JTH | J24189025 | | 1- | A | F1 |
| R 1111 | CHIP RES. | 68 | 1/16W | 5% | RMC1/16S 680JTH | J24189011 | | 1- | B | d3 |
| R 1112 | CHIP RES. | 100k | 1/16W | 5% | RMC1/16S 104JTH | J24189049 | | 1- | B | d3 |
| R 1113 | CHIP RES. | 100k | 1/16W | 5% | RMC1/16S 104JTH | J24189049 | | 1- | B | c3 |
| R 1114 | CHIP RES. | 18 | 1/16W | 5% | RMC1/16S 180JTH | J24189004 | | 1- | B | c1 |
| R 1114 | CHIP RES. | 10 | 1/16W | 5% | RMC1/16S 100JTH | J24189001 | | 79- | B | c1 |
| R 1115 | CHIP RES. | 470 | 1/16W | 5% | RMC1/16S 471JTH | J24189021 | | 1- | B | d3 |
| R 1116 | CHIP RES. | 33 | 1/16W | 5% | RMC1/16S 330JTH | J24189007 | | 1- | B | d3 |
| R 1117 | CHIP RES. | 68 | 1/16W | 5% | RMC1/16S 680JTH | J24189011 | | 1- | A | F1 |
| R 1117 | CHIP RES. | 120 | 1/16W | 5% | RMC1/16S 121JTH | J24189014 | | 79- | A | F1 |
| R 1118 | CHIP RES. | 68 | 1/16W | 5% | RMC1/16S 680JTH | J24189011 | | 1- | B | d4 |
| R 1119 | CHIP RES. | 470 | 1/16W | 5% | RMC1/16S 471JTH | J24189021 | | 1- | B | d3 |
| R 1120 | CHIP RES. | 470k | 1/16W | 5% | RMC1/16S 474JTH | J24189057 | | 1- | B | d2 |
| R 1121 | CHIP RES. | 470k | 1/16W | 5% | RMC1/16S 474JTH | J24189057 | | 1- | B | c3 |
| R 1122 | CHIP RES. | 18 | 1/16W | 5% | RMC1/16S 180JTH | J24189004 | | 1- | B | c1 |
| R 1122 | CHIP RES. | 10 | 1/16W | 5% | RMC1/16S 100JTH | J24189001 | | 79- | B | c1 |
| R 1123 | CHIP RES. | 33 | 1/16W | 5% | RMC1/16S 330JTH | J24189007 | | 1- | B | d4 |
| R 1124 | CHIP RES. | 10k | 1/16W | 5% | RMC1/16S 103JTH | J24189037 | | 1- | B | d3 |
| R 1125 | CHIP RES. | 4.7k | 1/16W | 5% | RMC1/16S 472JTH | J24189033 | | 1- | B | c3 |
| R 1126 | CHIP RES. | 1k | 1/16W | 5% | RMC1/16S 102JTH | J24189025 | | 1- | A | E3 |
| R 1127 | CHIP RES. | 10 | 1/16W | 5% | RMC1/16S 100JTH | J24189001 | | 1- | A | E3 |
| R 1128 | CHIP RES. | 10 | 1/16W | 5% | RMC1/16S 100JTH | J24189001 | | 1- | A | E3 |
| R 1129 | CHIP RES. | 100 | 1/16W | 5% | RMC1/16S 101JTH | J24189013 | | 1- | B | d4 |
| R 1130 | CHIP RES. | 470 | 1/16W | 5% | RMC1/16S 471JTH | J24189021 | | 1-67 | B | d4 |
| R 1131 | CHIP RES. | 33 | 1/16W | 5% | RMC1/16S 330JTH | J24189007 | | 1- | A | E4 |
| R 1132 | CHIP RES. | 10 | 1/16W | 5% | RMC1/16S 100JTH | J24189001 | | 1- | B | d1 |
| R 1132 | CHIP RES. | 27 | 1/16W | 5% | RMC1/16S 270JTH | J24189006 | | 40- | B | d1 |
| R 1132 | CHIP RES. | 22 | 1/16W | 5% | RMC1/16S 220JTH | J24189005 | | 79- | B | d1 |
| R 1133 | CHIP RES. | 470k | 1/16W | 5% | RMC1/16S 474JTH | J24189057 | | 1- | B | c3 |
| R 1134 | CHIP RES. | 100 | 1/16W | 5% | RMC1/16S 101JTH | J24189013 | | 1- | A | E1 |
| R 1135 | CHIP RES. | 150 | 1/16W | 5% | RMC1/16S 151JTH | J24189015 | | 1- | B | d1 |
| R 1135 | CHIP RES. | 27 | 1/16W | 5% | RMC1/16S 270JTH | J24189006 | | 40- | B | d1 |
| R 1135 | CHIP RES. | 56 | 1/16W | 5% | RMC1/16S 560JTH | J24189010 | | 79- | B | d1 |
| R 1136 | CHIP RES. | 1k | 1/16W | 5% | RMC1/16S 102JTH | J24189025 | | 1- | B | d1 |
| R 1137 | CHIP RES. | 1k | 1/16W | 5% | RMC1/16S 102JTH | J24189025 | | 1- | A | E2 |
| R 1138 | CHIP RES. | 1k | 1/16W | 5% | RMC1/16S 102JTH | J24189025 | | 1- | A | F2 |
| R 1139 | CHIP RES. | 1M | 1/16W | 5% | RMC1/16S 105JTH | J24189061 | | 1- | A | E1 |
| R 1141 | CHIP RES. | 22k | 1/16W | 5% | RMC1/16S 223JTH | J24189041 | | 1- | B | c6 |
| R 1142 | CHIP RES. | 10 | 1/16W | 5% | RMC1/16S 100JTH | J24189001 | | 1- | B | d1 |
| R 1142 | CHIP RES. | 27 | 1/16W | 5% | RMC1/16S 270JTH | J24189006 | | 40- | B | d1 |
| R 1142 | CHIP RES. | 22 | 1/16W | 5% | RMC1/16S 220JTH | J24189005 | | 79- | B | d1 |
| R 1143 | CHIP RES. | 470 | 1/16W | 5% | RMC1/16S 471JTH | J24189021 | | 1- | A | E1 |
| R 1144 | CHIP RES. | 1k | 1/16W | 5% | RMC1/16S 102JTH | J24189025 | | 1- | B | d3 |
| R 1145 | CHIP RES. | 1k | 1/16W | 5% | RMC1/16S 102JTH | J24189025 | | 1- | B | c2 |
| R 1146 | CHIP RES. | 100k | 1/16W | 5% | RMC1/16S 104JTH | J24189049 | | 1- | A | E1 |
| R 1147 | CHIP RES. | 100 | 1/16W | 5% | RMC1/16S 101JTH | J24189013 | | 1- | B | c1 |
| R 1148 | CHIP RES. | 1k | 1/16W | 5% | RMC1/16S 102JTH | J24189025 | | 1- | B | d3 |
| R 1149 | CHIP RES. | 100k | 1/16W | 5% | RMC1/16S 104JTH | J24189049 | | 1- | A | E1 |
| R 1150 | CHIP RES. | 33k | 1/16W | 5% | RMC1/16S 333JTH | J24189043 | | 1- | B | c7 |
| R 1151 | CHIP RES. | 470 | 1/16W | 5% | RMC1/16S 471JTH | J24189021 | | 1- | A | D1 |
| R 1153 | CHIP RES. | 10k | 1/16W | 5% | RMC1/16S 103JTH | J24189037 | | 1- | B | d3 |
| R 1154 | CHIP RES. | 1M | 1/16W | 5% | RMC1/16S 105JTH | J24189061 | | 1- | A | E1 |
| R 1155 | CHIP RES. | 100k | 1/16W | 5% | RMC1/16S 104JTH | J24189049 | | 1- | A | D1 |
| R 1156 | CHIP RES. | 82k | 1/16W | 5% | RMC1/16S 823JTH | J24189048 | | 1- | B | c7 |
| R 1157 | CHIP RES. | 47k | 1/16W | 5% | RMC1/16S 473JTH | J24189045 | | 1- | B | c6 |
| R 1158 | CHIP RES. | 1k | 1/16W | 5% | RMC1/16S 102JTH | J24189025 | | 1- | B | e1 |
| R 1159 | CHIP RES. | 4.7k | 1/16W | 5% | RMC1/16S 472JTH | J24189033 | | 1- | B | b7 |
| R 1160 | CHIP RES. | 100k | 1/16W | 5% | RMC1/16S 104JTH | J24189049 | | 1- | B | b7 |
| R 1161 | CHIP RES. | 100 | 1/16W | 5% | RMC1/16S 101JTH | J24189013 | | 1- | A | D1 |
| R 1162 | CHIP RES. | 4.7k | 1/16W | 5% | RMC1/16S 472JTH | J24189033 | | 1- | B | c6 |
| R 1163 | CHIP RES. | 10k | 1/16W | 5% | RMC1/16S 103JTH | J24189037 | | 1- | A | F7 |
| R 1164 | CHIP RES. | 1k | 1/16W | 5% | RMC1/16S 102JTH | J24189025 | | 1- | A | D1 |
| R 1165 | CHIP RES. | 3.3k | 1/16W | 5% | RMC1/16S 332JTH | J24189031 | | 1-6 | A | F7 |
| R 1166 | CHIP RES. | 47k | 1/16W | 5% | RMC1/16S 473JTH | J24189045 | | 1- | A | F7 |
| R 1167 | CHIP RES. | 47k | 1/16W | 5% | RMC1/16S 473JTH | J24189045 | | 1- | A | F7 |

MAIN Unit

Parts List

| REF | DESCRIPTION | VALUE | V/W | TOL. | MFR'S DESIG | VXSTD P/N | VERS. | LOT | SIDE | LAY ADR |
|--------|-------------|-------|-------|------|-----------------|-----------|-------|-------|------|---------|
| R 1168 | CHIP RES. | 47k | 1/16W | 5% | RMC1/16S 473JTH | J24189045 | | 1- | A | E5 |
| R 1169 | CHIP RES. | 100k | 1/16W | 5% | RMC1/16S 104JTH | J24189049 | | 1- | A | E5 |
| R 1170 | CHIP RES. | 10k | 1/16W | 5% | RMC1/16S 103JTH | J24189037 | | 1-17 | A | G6 |
| R 1171 | CHIP RES. | 100k | 1/16W | 5% | RMC1/16S 104JTH | J24189049 | | 1- | A | F6 |
| R 1172 | CHIP RES. | 1k | 1/16W | 5% | RMC1/16S 102JTH | J24189025 | | 1- | B | e1 |
| R 1173 | CHIP RES. | 100k | 1/16W | 5% | RMC1/16S 104JTH | J24189049 | | 1- | B | b6 |
| R 1174 | CHIP RES. | 470 | 1/16W | 5% | RMC1/16S 471JTH | J24189021 | | 1- | A | D1 |
| R 1175 | CHIP RES. | 100k | 1/16W | 5% | RMC1/16S 104JTH | J24189049 | | 1- | B | b6 |
| R 1175 | CHIP RES. | 220k | 1/16W | 5% | RMC1/16S 224JTH | J24189053 | | 7- | B | b6 |
| R 1176 | CHIP RES. | 100 | 1/16W | 5% | RMC1/16S 101JTH | J24189013 | | 1- | B | e1 |
| R 1177 | CHIP RES. | 100k | 1/16W | 5% | RMC1/16S 104JTH | J24189049 | | 1- | B | c6 |
| R 1178 | CHIP RES. | 47k | 1/16W | 5% | RMC1/16S 473JTH | J24189045 | | 1- | B | b6 |
| R 1179 | CHIP RES. | 22k | 1/16W | 5% | RMC1/16S 223JTH | J24189041 | | 1- | B | f2 |
| R 1181 | CHIP RES. | 22k | 1/16W | 5% | RMC1/16S 223JTH | J24189041 | | 1- | B | f2 |
| R 1183 | CHIP RES. | 22k | 1/16W | 5% | RMC1/16S 223JTH | J24189041 | | 1- | B | f2 |
| R 1184 | CHIP RES. | 10k | 1/16W | 5% | RMC1/16S 103JTH | J24189037 | | 1- | B | b6 |
| R 1185 | CHIP RES. | 22k | 1/16W | 5% | RMC1/16S 223JTH | J24189041 | | 1- | B | f2 |
| R 1186 | CHIP RES. | 1k | 1/16W | 5% | RMC1/16S 102JTH | J24189025 | | 1- | A | C3 |
| R 1187 | CHIP RES. | 10k | 1/16W | 5% | RMC1/16S 103JTH | J24189037 | | 1- | A | C3 |
| R 1188 | CHIP RES. | 10k | 1/16W | 5% | RMC1/16S 103JTH | J24189037 | | 1- | B | h1 |
| R 1189 | CHIP RES. | 100 | 1/16W | 5% | RMC1/16S 101JTH | J24189013 | | 1- | B | e1 |
| R 1190 | CHIP RES. | 1k | 1/16W | 5% | RMC1/16S 102JTH | J24189025 | | 1- | A | C3 |
| R 1191 | CHIP RES. | 1k | 1/16W | 5% | RMC1/16S 102JTH | J24189025 | | 1- | A | F2 |
| R 1192 | CHIP RES. | 1k | 1/16W | 5% | RMC1/16S 102JTH | J24189025 | | 1- | B | e1 |
| R 1193 | CHIP RES. | 100k | 1/16W | 5% | RMC1/16S 104JTH | J24189049 | | 1- | B | f3 |
| R 1194 | CHIP RES. | 120k | 1/16W | 5% | RMC1/16S 124JTH | J24189050 | | 1- | A | E5 |
| R 1195 | CHIP RES. | 10k | 1/16W | 5% | RMC1/16S 103JTH | J24189037 | | 1- | B | f3 |
| R 1196 | CHIP RES. | 1k | 1/16W | 5% | RMC1/16S 102JTH | J24189025 | | 1- | B | f3 |
| R 1197 | CHIP RES. | 330k | 1/16W | 5% | RMC1/16S 334JTH | J24189055 | | 1- | B | h1 |
| R 1198 | CHIP RES. | 150k | 1/16W | 5% | RMC1/16S 154JTH | J24189051 | | 1- | A | E5 |
| R 1199 | CHIP RES. | 1k | 1/16W | 5% | RMC1/16S 102JTH | J24189025 | | 1- | B | f3 |
| R 1200 | CHIP RES. | 4.7k | 1/16W | 5% | RMC1/16S 472JTH | J24189033 | | 1- | B | h1 |
| R 1201 | CHIP RES. | 100 | 1/16W | 5% | RMC1/16S 101JTH | J24189013 | | 1- | B | h1 |
| R 1202 | CHIP RES. | 4.7k | 1/16W | 5% | RMC1/16S 472JTH | J24189033 | | 1- | B | h1 |
| R 1203 | CHIP RES. | 3.3k | 1/16W | 5% | RMC1/16S 332JTH | J24189031 | | 1- | B | f3 |
| R 1204 | CHIP RES. | 100k | 1/16W | 5% | RMC1/16S 104JTH | J24189049 | | 1- | B | f3 |
| R 1205 | CHIP RES. | 470 | 1/16W | 5% | RMC1/16S 471JTH | J24189021 | | 1- | A | E3 |
| R 1206 | CHIP RES. | 330k | 1/16W | 5% | RMC1/16S 334JTH | J24189055 | | 1- | B | h1 |
| R 1207 | CHIP RES. | 2.2k | 1/16W | 5% | RMC1/16S 222JTH | J24189029 | | 1- | B | h1 |
| R 1208 | CHIP RES. | 47k | 1/16W | 5% | RMC1/16S 473JTH | J24189045 | | 1- | B | f3 |
| R 1209 | CHIP RES. | 1k | 1/16W | 5% | RMC1/16S 102JTH | J24189025 | | 1- | B | f1 |
| R 1210 | CHIP RES. | 10k | 1/16W | 5% | RMC1/16S 103JTH | J24189037 | | 1- | B | f3 |
| R 1211 | CHIP RES. | 100 | 1/16W | 5% | RMC1/16S 101JTH | J24189013 | | 1- | A | G5 |
| R 1211 | CHIP RES. | 0 | 1/16W | 5% | RMC1/16S JPTH | J24189070 | | 50- | A | G5 |
| R 1212 | CHIP RES. | 470k | 1/16W | 5% | RMC1/16S 474JTH | J24189057 | | 1- | A | E1 |
| R 1213 | CHIP RES. | 2.2k | 1/16W | 5% | RMC1/16S 222JTH | J24189029 | | 1- | B | d2 |
| R 1214 | CHIP RES. | 100k | 1/16W | 5% | RMC1/16S 104JTH | J24189049 | | 1- | B | f3 |
| R 1215 | CHIP RES. | 100 | 1/16W | 5% | RMC1/16S 101JTH | J24189013 | | 1- | B | h1 |
| R 1216 | CHIP RES. | 100k | 1/16W | 5% | RMC1/16S 104JTH | J24189049 | | 1- | B | f3 |
| R 1217 | CHIP RES. | 1k | 1/16W | 5% | RMC1/16S 102JTH | J24189025 | | 1- | B | g3 |
| R 1218 | CHIP RES. | 100k | 1/16W | 5% | RMC1/16S 104JTH | J24189049 | | 1- | A | F6 |
| R 1219 | CHIP RES. | 0 | 1/16W | 5% | RMC1/16 000JATP | J24185000 | | 1- | A | F5 |
| R 1220 | CHIP RES. | 220k | 1/16W | 5% | RMC1/16S 224JTH | J24189053 | | 1- | B | g3 |
| R 1221 | CHIP RES. | 100k | 1/16W | 5% | RMC1/16S 104JTH | J24189049 | | 1- | A | E5 |
| R 1222 | CHIP RES. | 47 | 1/16W | 5% | RMC1/16S 470JTH | J24189009 | | 1- | B | f3 |
| R 1223 | CHIP RES. | 1k | 1/16W | 5% | RMC1/16S 102JTH | J24189025 | | 1- | B | f3 |
| R 1224 | CHIP RES. | 2.2k | 1/16W | 5% | RMC1/16S 222JTH | J24189029 | | 1- | B | e2 |
| R 1225 | CHIP RES. | 100k | 1/16W | 5% | RMC1/16S 104JTH | J24189049 | | 1- | A | E5 |
| R 1226 | CHIP RES. | 10k | 1/16W | 5% | RMC1/16S 103JTH | J24189037 | | 1- | B | c1 |
| R 1228 | CHIP RES. | 1k | 1/16W | 5% | RMC1/16S 102JTH | J24189025 | | 1- | B | f3 |
| R 1229 | CHIP RES. | 150 | 1/16W | 5% | RMC1/16S 151JTH | J24189015 | | 1- | A | D2 |
| R 1230 | CHIP RES. | 150 | 1/16W | 5% | RMC1/16S 151JTH | J24189015 | | 1- | A | D2 |
| R 1231 | CHIP RES. | 10k | 1/16W | 5% | RMC1/16S 103JTH | J24189037 | | 1- | A | C3 |
| R 1232 | CHIP RES. | 100 | 1/16W | 5% | RMC1/16S 101JTH | J24189013 | | 1- | B | e3 |
| R 1232 | CHIP RES. | 100 | 1/16W | 5% | RMC1/16S 101JTH | J24189013 | | 29-39 | B | e3 |
| R 1233 | CHIP RES. | 33k | 1/16W | 5% | RMC1/16S 333JTH | J24189043 | | 1- | B | f3 |
| R 1234 | CHIP RES. | 10k | 1/16W | 5% | RMC1/16S 103JTH | J24189037 | | 1- | A | C3 |
| R 1235 | CHIP RES. | 100 | 1/16W | 5% | RMC1/16S 101JTH | J24189013 | | 1- | B | c2 |
| R 1236 | CHIP RES. | 22k | 1/16W | 5% | RMC1/16S 223JTH | J24189041 | | 1- | A | C3 |
| R 1237 | CHIP RES. | 47k | 1/16W | 5% | RMC1/16S 473JTH | J24189045 | | 1- | B | c1 |
| R 1238 | CHIP RES. | 10k | 1/16W | 5% | RMC1/16S 103JTH | J24189037 | | 1- | B | c1 |
| R 1239 | CHIP RES. | 10 | 1/16W | 5% | RMC1/16S 100JTH | J24189001 | | 1- | A | C2 |
| R 1239 | CHIP RES. | 150 | 1/16W | 5% | RMC1/16S 151JTH | J24189015 | | 18- | A | C2 |

MAIN Unit

Parts List

| REF | DESCRIPTION | VALUE | V/W | TOL. | MFR'S DESIG | VXSTD P/N | VERS. | LOT | SIDE | LAY ADR |
|--------|-------------|-------|-------|------|-----------------|-----------|-------|-----|------|---------|
| R 1240 | CHIP RES. | 4.7k | 1/16W | 5% | RMC1/16S 472JTH | J24189033 | | 1- | A | C3 |
| R 1241 | CHIP RES. | 22 | 1/16W | 5% | RMC1/16S 220JTH | J24189005 | | 1- | B | h2 |
| R 1242 | CHIP RES. | 10k | 1/16W | 5% | RMC1/16S 103JTH | J24189037 | | 1- | B | c2 |
| R 1243 | CHIP RES. | 100k | 1/16W | 5% | RMC1/16S 104JTH | J24189049 | | 1- | B | h2 |
| R 1244 | CHIP RES. | 56k | 1/16W | 5% | RMC1/16S 563JTH | J24189046 | | 1- | A | B3 |
| R 1245 | CHIP RES. | 100 | 1/16W | 5% | RMC1/16S 101JTH | J24189013 | | 1- | B | e2 |
| R 1245 | CHIP RES. | 100k | 1/16W | 5% | RMC1/16S 104JTH | J24189049 | | 4- | B | e2 |
| R 1246 | CHIP RES. | 2.2k | 1/16W | 5% | RMC1/16S 222JTH | J24189029 | | 1- | B | h2 |
| R 1247 | CHIP RES. | 82k | 1/16W | 5% | RMC1/16S 823JTH | J24189048 | | 1- | A | B3 |
| R 1248 | CHIP RES. | 470k | 1/16W | 5% | RMC1/16S 474JTH | J24189057 | | 1- | B | e2 |
| R 1248 | CHIP RES. | 330k | 1/16W | 5% | RMC1/16S 334JTH | J24189055 | | 4- | B | e2 |
| R 1248 | CHIP RES. | 150k | 1/16W | 5% | RMC1/16S 154JTH | J24189051 | | 18- | B | e2 |
| R 1249 | CHIP RES. | 3.9k | 1/16W | 5% | RMC1/16S 392JTH | J24189032 | | 1- | B | h2 |
| R 1250 | CHIP RES. | 33 | 1/16W | 5% | RMC1/16S 330JTH | J24189007 | | 1- | A | D2 |
| R 1251 | CHIP RES. | 220k | 1/16W | 5% | RMC1/16S 224JTH | J24189053 | | 18- | B | e2 |
| R 1252 | CHIP RES. | 100k | 1/16W | 5% | RMC1/16S 104JTH | J24189049 | | 1- | A | B3 |
| R 1253 | CHIP RES. | 10k | 1/16W | 5% | RMC1/16S 103JTH | J24189037 | | 1- | A | F6 |
| R 1254 | CHIP RES. | 22k | 1/16W | 5% | RMC1/16S 223JTH | J24189041 | | 1- | A | B3 |
| R 1255 | CHIP RES. | 68 | 1/16W | 5% | RMC1/16S 680JTH | J24189011 | | 1- | B | h2 |
| R 1256 | CHIP RES. | 2.2k | 1/16W | 5% | RMC1/16S 222JTH | J24189029 | | 1- | A | E5 |
| R 1257 | CHIP RES. | 3.3k | 1/16W | 5% | RMC1/16S 332JTH | J24189031 | | 1- | A | E2 |
| R 1258 | CHIP RES. | 4.7k | 1/16W | 5% | RMC1/16S 472JTH | J24189033 | | 1- | A | E2 |
| R 1259 | CHIP RES. | 470 | 1/16W | 5% | RMC1/16S 471JTH | J24189021 | | 1- | B | h2 |
| R 1260 | CHIP RES. | 1k | 1/16W | 5% | RMC1/16S 102JTH | J24189025 | | 1- | A | D3 |
| R 1262 | CHIP RES. | 4.7k | 1/16W | 5% | RMC1/16S 472JTH | J24189033 | | 1- | A | F5 |
| R 1263 | CHIP RES. | 4.7k | 1/16W | 5% | RMC1/16S 472JTH | J24189033 | | 1- | A | F5 |
| R 1264 | CHIP RES. | 470 | 1/16W | 5% | RMC1/16S 471JTH | J24189021 | | 1- | B | h2 |
| R 1265 | CHIP RES. | 1k | 1/16W | 5% | RMC1/16S 102JTH | J24189025 | | 1- | A | D3 |
| R 1266 | CHIP RES. | 2.2k | 1/16W | 5% | RMC1/16S 222JTH | J24189029 | | 1- | A | E5 |
| R 1267 | CHIP RES. | 470 | 1/16W | 5% | RMC1/16S 471JTH | J24189021 | | 1- | B | h2 |
| R 1268 | CHIP RES. | 1.5k | 1/16W | 5% | RMC1/16S 152JTH | J24189027 | | 1- | B | e3 |
| R 1270 | CHIP RES. | 1k | 1/16W | 5% | RMC1/16S 102JTH | J24189025 | | 1- | B | e2 |
| R 1272 | CHIP RES. | 100 | 1/16W | 5% | RMC1/16S 101JTH | J24189013 | | 1- | B | e2 |
| R 1273 | CHIP RES. | 1k | 1/16W | 5% | RMC1/16S 102JTH | J24189025 | | 1- | A | C3 |
| R 1274 | CHIP RES. | 100k | 1/16W | 5% | RMC1/16S 104JTH | J24189049 | | 1- | A | B4 |
| R 1275 | CHIP RES. | 100k | 1/16W | 5% | RMC1/16S 104JTH | J24189049 | | 1- | A | B4 |
| R 1276 | CHIP RES. | 100k | 1/16W | 5% | RMC1/16S 104JTH | J24189049 | | 1- | A | A3 |
| R 1277 | CHIP RES. | 10k | 1/16W | 5% | RMC1/16S 103JTH | J24189037 | | 1- | A | E5 |
| R 1278 | CHIP RES. | 1k | 1/16W | 5% | RMC1/16S 102JTH | J24189025 | | 1- | A | D3 |
| R 1280 | CHIP RES. | 100k | 1/16W | 5% | RMC1/16S 104JTH | J24189049 | | 1- | B | f4 |
| R 1281 | CHIP RES. | 100 | 1/16W | 5% | RMC1/16S 101JTH | J24189013 | | 1- | A | B4 |
| R 1282 | CHIP RES. | 47k | 1/16W | 5% | RMC1/16S 473JTH | J24189045 | | 1- | B | f4 |
| R 1283 | CHIP RES. | 22k | 1/16W | 5% | RMC1/16S 223JTH | J24189041 | | 1- | A | E5 |
| R 1284 | CHIP RES. | 4.7k | 1/16W | 5% | RMC1/16S 472JTH | J24189033 | | 1- | A | A4 |
| R 1285 | CHIP RES. | 100 | 1/16W | 5% | RMC1/16S 101JTH | J24189013 | | 1- | A | A4 |
| R 1286 | CHIP RES. | 68k | 1/16W | 5% | RMC1/16S 683JTH | J24189047 | | 1- | B | g4 |
| R 1287 | CHIP RES. | 470k | 1/16W | 5% | RMC1/16S 474JTH | J24189057 | | 1- | A | B4 |
| R 1288 | CHIP RES. | 22k | 1/16W | 5% | RMC1/16S 223JTH | J24189041 | | 1- | B | g4 |
| R 1289 | CHIP RES. | 22k | 1/16W | 5% | RMC1/16S 223JTH | J24189041 | | 1- | A | B4 |
| R 1289 | CHIP RES. | 15k | 1/16W | 5% | RMC1/16S 153JTH | J24189039 | | 29- | A | B4 |
| R 1290 | CHIP RES. | 100k | 1/16W | 5% | RMC1/16S 104JTH | J24189049 | | 1- | A | B4 |
| R 1290 | CHIP RES. | 22k | 1/16W | 5% | RMC1/16S 223JTH | J24189041 | | 18- | A | B4 |
| R 1291 | CHIP RES. | 100k | 1/16W | 5% | RMC1/16S 104JTH | J24189049 | | 1- | A | B3 |
| R 1291 | CHIP RES. | 22k | 1/16W | 5% | RMC1/16S 223JTH | J24189041 | | 18- | A | B3 |
| R 1292 | CHIP RES. | 220k | 1/16W | 5% | RMC1/16S 224JTH | J24189053 | | 1- | A | B3 |
| R 1293 | CHIP RES. | 1k | 1/16W | 5% | RMC1/16S 102JTH | J24189025 | | 1- | A | B4 |
| R 1294 | CHIP RES. | 39k | 1/16W | 5% | RMC1/16S 393JTH | J24189044 | | 1- | A | A3 |
| R 1295 | CHIP RES. | 22k | 1/16W | 5% | RMC1/16S 223JTH | J24189041 | | 1- | A | E5 |
| R 1296 | CHIP RES. | 3.3k | 1/16W | 5% | RMC1/16S 332JTH | J24189031 | | 1- | B | e4 |
| R 1297 | CHIP RES. | 47k | 1/16W | 5% | RMC1/16S 473JTH | J24189045 | | 1- | A | B3 |
| R 1298 | CHIP RES. | 470k | 1/16W | 5% | RMC1/16S 474JTH | J24189057 | | 1- | A | B4 |
| R 1299 | CHIP RES. | 22k | 1/16W | 5% | RMC1/16S 223JTH | J24189041 | | 1- | A | A5 |
| R 1300 | CHIP RES. | 4.7k | 1/16W | 5% | RMC1/16S 472JTH | J24189033 | | 1- | B | e4 |
| R 1301 | CHIP RES. | 6.8k | 1/16W | 5% | RMC1/16S 682JTH | J24189035 | | 1- | B | h5 |
| R 1302 | CHIP RES. | 1k | 1/16W | 5% | RMC1/16S 102JTH | J24189025 | | 1- | A | C3 |
| R 1303 | CHIP RES. | 10k | 1/16W | 5% | RMC1/16S 103JTH | J24189037 | | 1- | B | h4 |
| R 1304 | CHIP RES. | 100k | 1/16W | 5% | RMC1/16S 104JTH | J24189049 | | 1- | B | h4 |
| R 1305 | CHIP RES. | 10k | 1/16W | 5% | RMC1/16S 103JTH | J24189037 | | 1- | A | D5 |
| R 1306 | CHIP RES. | 680 | 1/16W | 5% | RMC1/16S 681JTH | J24189023 | | 1- | B | e3 |
| R 1306 | CHIP RES. | 1k | 1/16W | 5% | RMC1/16S 102JTH | J24189025 | | 4- | B | e3 |
| R 1306 | CHIP RES. | 470 | 1/16W | 5% | RMC1/16S 471JTH | J24189021 | | 18- | B | e3 |
| R 1307 | CHIP RES. | 10k | 1/16W | 5% | RMC1/16S 103JTH | J24189037 | | 1- | A | B3 |
| R 1308 | CHIP RES. | 10k | 1/16W | 5% | RMC1/16S 103JTH | J24189037 | | 1- | B | g3 |

MAIN Unit

Parts List

| REF | DESCRIPTION | VALUE | V/W | TOL. | MFR'S DESIG | VXSTD P/N | VERS. | LOT | SIDE | LAY ADR |
|--------|-------------|-------|-------|------|-----------------|-----------|-----------|-----|------|---------|
| R 1309 | CHIP RES. | 1k | 1/16W | 5% | RMC1/16S 102JTH | J24189025 | | 1- | A | B4 |
| R 1310 | CHIP RES. | 68k | 1/16W | 5% | RMC1/16S 683JTH | J24189047 | | 1- | B | h4 |
| R 1311 | CHIP RES. | 150k | 1/16W | 5% | RMC1/16S 154JTH | J24189051 | | 1- | B | g3 |
| R 1312 | CHIP RES. | 150k | 1/16W | 5% | RMC1/16S 154JTH | J24189051 | | 1- | A | B3 |
| R 1313 | CHIP RES. | 22k | 1/16W | 5% | RMC1/16S 223JTH | J24189041 | | 1- | A | C5 |
| R 1314 | CHIP RES. | 220k | 1/16W | 5% | RMC1/16S 224JTH | J24189053 | | 1- | B | e4 |
| R 1314 | CHIP RES. | 150k | 1/16W | 5% | RMC1/16S 154JTH | J24189051 | | 18- | B | e4 |
| R 1315 | CHIP RES. | 100 | 1/16W | 5% | RMC1/16S 101JTH | J24189013 | | 1- | B | h6 |
| R 1316 | CHIP RES. | 470k | 1/16W | 5% | RMC1/16S 474JTH | J24189057 | | 1- | A | A3 |
| R 1317 | CHIP RES. | 10k | 1/16W | 5% | RMC1/16S 103JTH | J24189037 | | 1- | A | B3 |
| R 1318 | CHIP RES. | 1M | 1/16W | 5% | RMC1/16S 105JTH | J24189061 | | 1- | B | e4 |
| R 1319 | CHIP RES. | 100 | 1/16W | 5% | RMC1/16S 101JTH | J24189013 | | 1- | B | e5 |
| R 1320 | CHIP RES. | 4.7k | 1/16W | 5% | RMC1/16S 472JTH | J24189033 | | 1- | B | h5 |
| R 1321 | CHIP RES. | 4.7k | 1/16W | 5% | RMC1/16S 472JTH | J24189033 | | 1- | B | g3 |
| R 1322 | CHIP RES. | 220k | 1/16W | 5% | RMC1/16S 224JTH | J24189053 | | 1- | B | f3 |
| R 1323 | CHIP RES. | 33k | 1/16W | 5% | RMC1/16S 333JTH | J24189043 | | 1- | A | B3 |
| R 1324 | CHIP RES. | 680k | 1/16W | 5% | RMC1/16S 684JTH | J24189059 | | 1- | B | h5 |
| R 1325 | CHIP RES. | 3.3k | 1/16W | 5% | RMC1/16S 332JTH | J24189031 | | 1- | A | B4 |
| R 1326 | CHIP RES. | 100k | 1/16W | 5% | RMC1/16S 104JTH | J24189049 | | 1- | B | e5 |
| R 1327 | CHIP RES. | 100 | 1/16W | 5% | RMC1/16S 101JTH | J24189013 | | 1- | B | g4 |
| R 1328 | CHIP RES. | 33k | 1/16W | 5% | RMC1/16S 333JTH | J24189043 | | 1- | A | B3 |
| R 1329 | CHIP RES. | 1.5k | 1/16W | 5% | RMC1/16S 152JTH | J24189027 | | 1- | A | B4 |
| R 1330 | CHIP RES. | 100 | 1/16W | 5% | RMC1/16S 101JTH | J24189013 | | 1- | A | C4 |
| R 1330 | CHIP RES. | 150 | 1/16W | 5% | RMC1/16S 151JTH | J24189015 | | 18- | A | C4 |
| R 1331 | CHIP RES. | 10k | 1/16W | 5% | RMC1/16S 103JTH | J24189037 | | 1- | B | e5 |
| R 1332 | CHIP RES. | 100 | 1/16W | 5% | RMC1/16S 101JTH | J24189013 | | 1- | A | C4 |
| R 1333 | CHIP RES. | 4.7k | 1/16W | 5% | RMC1/16S 472JTH | J24189033 | | 1- | B | g4 |
| R 1334 | CHIP RES. | 1k | 1/16W | 5% | RMC1/16S 102JTH | J24189025 | | 1- | B | g4 |
| R 1335 | CHIP RES. | 10k | 1/16W | 5% | RMC1/16S 103JTH | J24189037 | | 1- | B | h5 |
| R 1336 | CHIP RES. | 100 | 1/16W | 5% | RMC1/16S 101JTH | J24189013 | | 1- | B | e5 |
| R 1337 | CHIP RES. | 4.7k | 1/16W | 5% | RMC1/16S 472JTH | J24189033 | | 1- | B | g3 |
| R 1338 | CHIP RES. | 1k | 1/16W | 5% | RMC1/16S 102JTH | J24189025 | | 1- | B | h5 |
| R 1339 | CHIP RES. | 3.3k | 1/16W | 5% | RMC1/16S 332JTH | J24189031 | | 1- | B | h5 |
| R 1340 | CHIP RES. | 2.2k | 1/16W | 5% | RMC1/16S 222JTH | J24189029 | | 1- | A | D4 |
| R 1340 | CHIP RES. | 4.7k | 1/16W | 5% | RMC1/16S 472JTH | J24189033 | | 73- | A | D4 |
| R 1341 | CHIP RES. | 100k | 1/16W | 5% | RMC1/16S 104JTH | J24189049 | | 1- | B | g4 |
| R 1342 | CHIP RES. | 10k | 1/16W | 5% | RMC1/16S 103JTH | J24189037 | | 18- | B | c5 |
| R 1343 | CHIP RES. | 10k | 1/16W | 5% | RMC1/16S 103JTH | J24189037 | | 18- | B | c5 |
| R 1344 | CHIP RES. | 470k | 1/16W | 5% | RMC1/16S 474JTH | J24189057 | | 1- | B | g3 |
| R 1345 | CHIP RES. | 330k | 1/16W | 5% | RMC1/16S 334JTH | J24189055 | | 1- | B | g5 |
| R 1346 | CHIP RES. | 100k | 1/16W | 5% | RMC1/16S 104JTH | J24189049 | | 1- | A | D5 |
| R 1347 | CHIP RES. | 3.3k | 1/16W | 5% | RMC1/16S 332JTH | J24189031 | | 1- | A | B3 |
| R 1348 | CHIP RES. | 100k | 1/16W | 5% | RMC1/16S 104JTH | J24189049 | | 1- | B | e5 |
| R 1349 | CHIP RES. | 1k | 1/16W | 5% | RMC1/16S 102JTH | J24189025 | | 1- | A | B4 |
| R 1350 | CHIP RES. | 2.2k | 1/16W | 5% | RMC1/16S 222JTH | J24189029 | | 1- | B | h6 |
| R 1351 | CHIP RES. | 4.7k | 1/16W | 5% | RMC1/16S 472JTH | J24189033 | | 1- | B | h6 |
| R 1352 | CHIP RES. | 1.5k | 1/16W | 5% | RMC1/16S 152JTH | J24189027 | | 1- | A | A5 |
| R 1353 | CHIP RES. | 100 | 1/16W | 5% | RMC1/16S 101JTH | J24189013 | | 1- | B | g5 |
| R 1353 | CHIP RES. | 150 | 1/16W | 5% | RMC1/16S 151JTH | J24189015 | | 18- | B | g5 |
| R 1354 | CHIP RES. | 33k | 1/16W | 5% | RMC1/16S 333JTH | J24189043 | AUSTRALIA | 1- | B | g3 |
| R 1354 | CHIP RES. | 33k | 1/16W | 5% | RMC1/16S 333JTH | J24189043 | EXPORT | 1- | B | g3 |
| R 1354 | CHIP RES. | 33k | 1/16W | 5% | RMC1/16S 333JTH | J24189043 | FRANCE | 1- | B | g3 |
| R 1354 | CHIP RES. | 68k | 1/16W | 5% | RMC1/16S 683JTH | J24189047 | JAPAN | 1- | B | g3 |
| R 1354 | CHIP RES. | 33k | 1/16W | 5% | RMC1/16S 333JTH | J24189043 | USA | 1- | B | g3 |
| R 1355 | CHIP RES. | 22k | 1/16W | 5% | RMC1/16S 223JTH | J24189041 | | 1- | B | g3 |
| R 1356 | CHIP RES. | 100 | 1/16W | 5% | RMC1/16S 101JTH | J24189013 | | 1- | B | e5 |
| R 1357 | CHIP RES. | 1k | 1/16W | 5% | RMC1/16S 102JTH | J24189025 | | 1- | A | B5 |
| R 1358 | CHIP RES. | 10k | 1/16W | 5% | RMC1/16S 103JTH | J24189037 | | 1- | B | f3 |
| R 1359 | CHIP RES. | 47k | 1/16W | 5% | RMC1/16S 473JTH | J24189045 | | 1- | B | g3 |
| R 1360 | CHIP RES. | 470k | 1/16W | 5% | RMC1/16S 474JTH | J24189057 | | 1- | B | g3 |
| R 1361 | CHIP RES. | 10k | 1/16W | 5% | RMC1/16S 103JTH | J24189037 | | 18- | B | c5 |
| R 1362 | CHIP RES. | 10k | 1/16W | 5% | RMC1/16S 103JTH | J24189037 | | 18- | B | c6 |
| R 1363 | CHIP RES. | 150k | 1/16W | 5% | RMC1/16S 154JTH | J24189051 | | 1- | B | g4 |
| R 1363 | CHIP RES. | 33k | 1/16W | 5% | RMC1/16S 333JTH | J24189043 | | 18- | B | g4 |
| R 1364 | CHIP RES. | 100 | 1/16W | 5% | RMC1/16S 101JTH | J24189013 | | 1- | B | e5 |
| R 1365 | CHIP RES. | 22k | 1/16W | 5% | RMC1/16S 223JTH | J24189041 | | 1- | B | e5 |
| R 1366 | CHIP RES. | 470 | 1/16W | 5% | RMC1/16S 471JTH | J24189021 | | 1- | B | g3 |
| R 1367 | CHIP RES. | 3.3k | 1/16W | 5% | RMC1/16S 332JTH | J24189031 | | 18- | B | c5 |
| R 1368 | CHIP RES. | 3.3k | 1/16W | 5% | RMC1/16S 332JTH | J24189031 | | 18- | B | c4 |
| R 1369 | CHIP RES. | 4.7k | 1/16W | 5% | RMC1/16S 472JTH | J24189033 | | 1- | B | e5 |
| R 1370 | CHIP RES. | 33k | 1/16W | 5% | RMC1/16S 333JTH | J24189043 | | 18- | B | c4 |
| R 1371 | CHIP RES. | 3.3k | 1/16W | 5% | RMC1/16S 332JTH | J24189031 | | 18- | B | c6 |
| R 1372 | CHIP RES. | 3.3k | 1/16W | 5% | RMC1/16S 332JTH | J24189031 | | 18- | B | c5 |

MAIN Unit

Parts List

| REF | DESCRIPTION | VALUE | V/W | TOL. | MFR'S DESIG | VXSTD P/N | VERS. | LOT | SIDE | LAY ADR |
|--------|-------------|-------|-------|------|-----------------|-----------|-------|-----|------|---------|
| R 1373 | CHIP RES. | 470 | 1/16W | 5% | RMC1/16S 471JTH | J24189021 | | 1- | B | g3 |
| R 1374 | CHIP RES. | 68k | 1/16W | 5% | RMC1/16S 683JTH | J24189047 | | 18- | B | c5 |
| R 1375 | CHIP RES. | 10k | 1/16W | 5% | RMC1/16S 103JTH | J24189037 | | 18- | B | c6 |
| R 1376 | CHIP RES. | 10k | 1/16W | 5% | RMC1/16S 103JTH | J24189037 | | 18- | B | c5 |
| R 1377 | CHIP RES. | 470 | 1/16W | 5% | RMC1/16S 471JTH | J24189021 | | 1- | B | g3 |
| R 1379 | CHIP RES. | 100 | 1/16W | 5% | RMC1/16S 101JTH | J24189013 | | 1- | B | g4 |
| R 1380 | CHIP RES. | 100 | 1/16W | 5% | RMC1/16S 101JTH | J24189013 | | 1- | A | A5 |
| R 1381 | CHIP RES. | 470k | 1/16W | 5% | RMC1/16S 474JTH | J24189057 | | 1- | B | h3 |
| R 1382 | CHIP RES. | 10k | 1/16W | 5% | RMC1/16S 103JTH | J24189037 | | 18- | B | c6 |
| R 1383 | CHIP RES. | 10k | 1/16W | 5% | RMC1/16S 103JTH | J24189037 | | 18- | B | c5 |
| R 1384 | CHIP RES. | 5.6k | 1/16W | 5% | RMC1/16S 562JTH | J24189034 | | 1- | B | f3 |
| R 1385 | CHIP RES. | 100k | 1/16W | 5% | RMC1/16S 104JTH | J24189049 | | 1- | A | D5 |
| R 1386 | CHIP RES. | 220k | 1/16W | 5% | RMC1/16S 224JTH | J24189053 | | 1- | B | g5 |
| R 1386 | CHIP RES. | 150k | 1/16W | 5% | RMC1/16S 154JTH | J24189051 | | 18- | B | g5 |
| R 1387 | CHIP RES. | 220k | 1/16W | 5% | RMC1/16S 224JTH | J24189053 | | 1- | B | g3 |
| R 1388 | CHIP RES. | 15k | 1/16W | 5% | RMC1/16S 153JTH | J24189039 | | 1- | B | g3 |
| R 1389 | CHIP RES. | 2.2k | 1/16W | 5% | RMC1/16S 222JTH | J24189029 | | 1- | B | g5 |
| R 1390 | CHIP RES. | 100 | 1/16W | 5% | RMC1/16S 101JTH | J24189013 | | 1- | B | h6 |
| R 1391 | CHIP RES. | 150 | 1/16W | 5% | RMC1/16S 151JTH | J24189015 | | 1- | B | f5 |
| R 1391 | CHIP RES. | 330 | 1/16W | 5% | RMC1/16S 331JTH | J24189019 | | 76- | B | f5 |
| R 1392 | CHIP RES. | 68k | 1/16W | 5% | RMC1/16S 683JTH | J24189047 | | 1- | A | D5 |
| R 1393 | CHIP RES. | 68k | 1/16W | 5% | RMC1/16S 683JTH | J24189047 | | 18- | B | c5 |
| R 1394 | CHIP RES. | 1k | 1/16W | 5% | RMC1/16S 102JTH | J24189025 | | 1- | A | C4 |
| R 1395 | CHIP RES. | 47k | 1/16W | 5% | RMC1/16S 473JTH | J24189045 | | 1- | A | B3 |
| R 1396 | CHIP RES. | 100k | 1/16W | 5% | RMC1/16S 104JTH | J24189049 | | 1 | B | g3 |
| R 1396 | CHIP RES. | 10k | 1/16W | 5% | RMC1/16S 103JTH | J24189037 | | 2- | B | g3 |
| R 1397 | CHIP RES. | 100k | 1/16W | 5% | RMC1/16S 104JTH | J24189049 | | 1- | B | g3 |
| R 1398 | CHIP RES. | 68k | 1/16W | 5% | RMC1/16S 683JTH | J24189047 | | 18- | B | c5 |
| R 1399 | CHIP RES. | 100 | 1/10W | 5% | RMC1/10T 101J | J24205101 | | 18- | B | b4 |
| R 1400 | CHIP RES. | 33k | 1/16W | 5% | RMC1/16S 333JTH | J24189043 | | 1- | B | f3 |
| R 1401 | CHIP RES. | 470k | 1/16W | 5% | RMC1/16S 474JTH | J24189057 | | 1- | B | h3 |
| R 1402 | CHIP RES. | 100 | 1/16W | 5% | RMC1/16S 101JTH | J24189013 | | 1- | A | D5 |
| R 1403 | CHIP RES. | 2.2k | 1/16W | 5% | RMC1/16S 222JTH | J24189029 | | 1- | A | D5 |
| R 1404 | CHIP RES. | 10k | 1/16W | 5% | RMC1/16S 103JTH | J24189037 | | 1- | A | C4 |
| R 1405 | CHIP RES. | 3.3k | 1/16W | 5% | RMC1/16S 332JTH | J24189031 | | 18- | B | c6 |
| R 1406 | CHIP RES. | 3.3k | 1/16W | 5% | RMC1/16S 332JTH | J24189031 | | 18- | B | c5 |
| R 1407 | CHIP RES. | 100 | 1/16W | 5% | RMC1/16S 101JTH | J24189013 | | 1- | B | g5 |
| R 1407 | CHIP RES. | 150 | 1/16W | 5% | RMC1/16S 151JTH | J24189015 | | 18- | B | g5 |
| R 1408 | CHIP RES. | 100 | 1/16W | 5% | RMC1/16S 101JTH | J24189013 | | 1- | A | C4 |
| R 1409 | CHIP RES. | 10k | 1/16W | 5% | RMC1/16S 103JTH | J24189037 | | 1- | B | g5 |
| R 1410 | CHIP RES. | 10k | 1/16W | 5% | RMC1/16S 103JTH | J24189037 | | 1- | B | g5 |
| R 1411 | CHIP RES. | 330 | 1/16W | 5% | RMC1/16S 331JTH | J24189019 | | 18- | B | c6 |
| R 1412 | CHIP RES. | 330 | 1/16W | 5% | RMC1/16S 331JTH | J24189019 | | 18- | B | c6 |
| R 1413 | CHIP RES. | 330 | 1/16W | 5% | RMC1/16S 331JTH | J24189019 | | 18- | B | c5 |
| R 1414 | CHIP RES. | 330 | 1/16W | 5% | RMC1/16S 331JTH | J24189019 | | 18- | B | c5 |
| R 1415 | CHIP RES. | 4.7k | 1/16W | 5% | RMC1/16S 472JTH | J24189033 | | 1- | B | f3 |
| R 1416 | CHIP RES. | 10k | 1/16W | 5% | RMC1/16S 103JTH | J24189037 | | 1- | B | g3 |
| R 1417 | CHIP RES. | 6.8k | 1/16W | 5% | RMC1/16S 682JTH | J24189035 | | 1- | B | g3 |
| R 1418 | CHIP RES. | 10k | 1/16W | 5% | RMC1/16S 103JTH | J24189037 | | 1- | B | g5 |
| R 1419 | CHIP RES. | 33 | 1/16W | 5% | RMC1/16S 330JTH | J24189007 | | 1- | B | e5 |
| R 1420 | CHIP RES. | 680k | 1/16W | 5% | RMC1/16S 684JTH | J24189059 | | 1- | B | g3 |
| R 1420 | CHIP RES. | 330k | 1/16W | 5% | RMC1/16S 334JTH | J24189055 | | 73- | B | g3 |
| R 1421 | CHIP RES. | 150k | 1/16W | 5% | RMC1/16S 154JTH | J24189051 | | 1- | A | B3 |
| R 1421 | CHIP RES. | 100k | 1/16W | 5% | RMC1/16S 104JTH | J24189049 | | 18- | A | B3 |
| R 1421 | CHIP RES. | 82k | 1/16W | 5% | RMC1/16S 823JTH | J24189048 | | 28- | A | B3 |
| R 1422 | CHIP RES. | 2.2M | 1/16W | 5% | RMC1/16S 225JTH | J24189065 | | 1- | B | f3 |
| R 1423 | CHIP RES. | 6.8k | 1/16W | 5% | RMC1/16S 682JTH | J24189035 | | 18- | B | c5 |
| R 1424 | CHIP RES. | 100 | 1/16W | 5% | RMC1/16S 101JTH | J24189013 | | 1- | B | f4 |
| R 1425 | CHIP RES. | 10k | 1/16W | 5% | RMC1/16S 103JTH | J24189037 | | 1- | B | g6 |
| R 1426 | CHIP RES. | 10k | 1/16W | 5% | RMC1/16S 103JTH | J24189037 | | 1- | B | g6 |
| R 1427 | CHIP RES. | 100k | 1/16W | 5% | RMC1/16S 104JTH | J24189049 | | 1- | B | g5 |
| R 1428 | CHIP RES. | 10k | 1/16W | 5% | RMC1/16S 103JTH | J24189037 | | 1- | A | B3 |
| R 1429 | CHIP RES. | 100k | 1/16W | 5% | RMC1/16S 104JTH | J24189049 | | 1- | B | f4 |
| R 1430 | CHIP RES. | 100 | 1/16W | 5% | RMC1/16S 101JTH | J24189013 | | 1- | B | g5 |
| R 1431 | CHIP RES. | 2.2k | 1/16W | 5% | RMC1/16S 222JTH | J24189029 | | 1- | B | f4 |
| R 1432 | CHIP RES. | 6.8k | 1/16W | 5% | RMC1/16S 682JTH | J24189035 | | 18- | B | c5 |
| R 1433 | CHIP RES. | 4.7k | 1/16W | 5% | RMC1/16S 472JTH | J24189033 | | 1- | B | f4 |
| R 1434 | CHIP RES. | 1k | 1/16W | 5% | RMC1/16S 102JTH | J24189025 | | 1- | A | C5 |
| R 1435 | CHIP RES. | 220k | 1/16W | 5% | RMC1/16S 224JTH | J24189053 | | 1- | B | g5 |
| R 1435 | CHIP RES. | 150k | 1/16W | 5% | RMC1/16S 154JTH | J24189051 | | 18- | B | g5 |
| R 1436 | CHIP RES. | 22k | 1/16W | 5% | RMC1/16S 223JTH | J24189041 | | 1- | B | g3 |
| R 1437 | CHIP RES. | 1.5k | 1/16W | 5% | RMC1/16S 152JTH | J24189027 | | 1- | B | g3 |
| R 1437 | CHIP RES. | 2.2k | 1/16W | 5% | RMC1/16S 222JTH | J24189029 | | 79- | B | g3 |

MAIN Unit

Parts List

| REF | DESCRIPTION | VALUE | V/W | TOL. | MFR'S DESIG | VXSTD P/N | VERS. | LOT | SIDE | LAY ADR |
|--------|-------------|-------|-------|------|-----------------|-----------|-------|-----|------|---------|
| R 1438 | CHIP RES. | 68 | 1/16W | 5% | RMC1/16S 680JTH | J24189011 | | 1- | B | f5 |
| R 1438 | CHIP RES. | 22 | 1/16W | 5% | RMC1/16S 220JTH | J24189005 | | 76- | B | f5 |
| R 1439 | CHIP RES. | 22k | 1/16W | 5% | RMC1/16S 223JTH | J24189041 | | 1- | B | e6 |
| R 1440 | CHIP RES. | 10k | 1/16W | 5% | RMC1/16S 103JTH | J24189037 | | 1- | A | D6 |
| R 1441 | CHIP RES. | 100k | 1/16W | 5% | RMC1/16S 104JTH | J24189049 | | 1- | B | g5 |
| R 1441 | CHIP RES. | 47k | 1/16W | 5% | RMC1/16S 473JTH | J24189045 | | 18- | B | g5 |
| R 1442 | CHIP RES. | 470 | 1/16W | 5% | RMC1/16S 471JTH | J24189021 | | 1- | B | g5 |
| R 1443 | CHIP RES. | 1M | 1/16W | 5% | RMC1/16S 105JTH | J24189061 | | 1- | B | f4 |
| R 1444 | CHIP RES. | 270k | 1/16W | 5% | RMC1/16S 274JTH | J24189054 | | 1 | A | B3 |
| R 1444 | CHIP RES. | 220k | 1/16W | 5% | RMC1/16S 224JTH | J24189053 | | 2- | A | B3 |
| R 1444 | CHIP RES. | 150k | 1/16W | 5% | RMC1/16S 154JTH | J24189051 | | 18- | A | B3 |
| R 1446 | CHIP RES. | 100 | 1/16W | 5% | RMC1/16S 101JTH | J24189013 | | 1- | A | B5 |
| R 1447 | CHIP RES. | 2.2k | 1/16W | 5% | RMC1/16S 222JTH | J24189029 | | 1- | B | g6 |
| R 1448 | CHIP RES. | 22k | 1/16W | 5% | RMC1/16S 223JTH | J24189041 | | 1- | B | h3 |
| R 1449 | CHIP RES. | 100k | 1/16W | 5% | RMC1/16S 104JTH | J24189049 | | 1- | B | f4 |
| R 1450 | CHIP RES. | 470k | 1/16W | 5% | RMC1/16S 474JTH | J24189057 | | 1- | B | g3 |
| R 1451 | CHIP RES. | 22k | 1/16W | 5% | RMC1/16S 223JTH | J24189041 | | 1- | B | h3 |
| R 1452 | CHIP RES. | 470 | 1/16W | 5% | RMC1/16S 471JTH | J24189021 | | 1- | A | B5 |
| R 1453 | CHIP RES. | 1k | 1/16W | 5% | RMC1/16S 102JTH | J24189025 | | 1- | B | f4 |
| R 1454 | CHIP RES. | 220 | 1/16W | 5% | RMC1/16S 221JTH | J24189017 | | 1- | A | C5 |
| R 1455 | CHIP RES. | 2.2M | 1/16W | 5% | RMC1/16S 225JTH | J24189065 | | 1- | A | A5 |
| R 1456 | CHIP RES. | 220k | 1/16W | 5% | RMC1/16S 224JTH | J24189053 | | 1- | B | g6 |
| R 1457 | CHIP RES. | 47k | 1/16W | 5% | RMC1/16S 473JTH | J24189045 | | 1- | B | e6 |
| R 1458 | CHIP RES. | 100k | 1/16W | 5% | RMC1/16S 104JTH | J24189049 | | 1- | A | A4 |
| R 1459 | CHIP RES. | 6.8k | 1/16W | 5% | RMC1/16S 682JTH | J24189035 | | 18- | B | c5 |
| R 1461 | CHIP RES. | 6.8k | 1/16W | 5% | RMC1/16S 682JTH | J24189035 | | 1- | B | g4 |
| R 1462 | CHIP RES. | 470 | 1/16W | 5% | RMC1/16S 471JTH | J24189021 | | 18- | B | b5 |
| R 1463 | CHIP RES. | 68k | 1/16W | 5% | RMC1/16S 683JTH | J24189047 | | 1- | A | B3 |
| R 1463 | CHIP RES. | 47k | 1/16W | 5% | RMC1/16S 473JTH | J24189045 | | 29- | A | B3 |
| R 1464 | CHIP RES. | 22k | 1/16W | 5% | RMC1/16S 223JTH | J24189041 | | 1- | B | e6 |
| R 1466 | CHIP RES. | 1k | 1/16W | 5% | RMC1/16S 102JTH | J24189025 | | 1- | B | e5 |
| R 1467 | CHIP RES. | 6.8k | 1/16W | 5% | RMC1/16S 682JTH | J24189035 | | 18- | B | c5 |
| R 1468 | CHIP RES. | 330k | 1/16W | 5% | RMC1/16S 334JTH | J24189055 | | 1- | B | f5 |
| R 1469 | CHIP RES. | 4.7k | 1/16W | 5% | RMC1/16S 472JTH | J24189033 | | 18- | A | B4 |
| R 1470 | CHIP RES. | 4.7k | 1/16W | 5% | RMC1/16S 472JTH | J24189033 | | 1- | B | e6 |
| R 1471 | CHIP RES. | 33k | 1/16W | 5% | RMC1/16S 333JTH | J24189043 | | 1- | B | g3 |
| R 1472 | CHIP RES. | 100 | 1/16W | 5% | RMC1/16S 101JTH | J24189013 | | 1- | B | f5 |
| R 1473 | CHIP RES. | 33k | 1/16W | 5% | RMC1/16S 333JTH | J24189043 | | 1- | B | g3 |
| R 1474 | CHIP RES. | 2.2M | 1/16W | 5% | RMC1/16S 225JTH | J24189065 | | 18- | B | c5 |
| R 1475 | CHIP RES. | 10k | 1/16W | 5% | RMC1/16S 103JTH | J24189037 | | 1- | B | g4 |
| R 1476 | CHIP RES. | 2.2k | 1/16W | 5% | RMC1/16S 222JTH | J24189029 | | 1- | A | C6 |
| R 1477 | CHIP RES. | 100k | 1/16W | 5% | RMC1/16S 104JTH | J24189049 | | 1- | B | g4 |
| R 1477 | CHIP RES. | 68k | 1/16W | 5% | RMC1/16S 683JTH | J24189047 | | 79- | B | g4 |
| R 1478 | CHIP RES. | 33k | 1/16W | 5% | RMC1/16S 333JTH | J24189043 | | 1- | B | g4 |
| R 1479 | CHIP RES. | 470 | 1/16W | 5% | RMC1/16S 471JTH | J24189021 | | 1- | A | A4 |
| R 1479 | CHIP RES. | 100 | 1/16W | 5% | RMC1/16S 101JTH | J24189013 | | 18- | A | A4 |
| R 1482 | CHIP RES. | 4.7k | 1/16W | 5% | RMC1/16S 472JTH | J24189033 | | 1- | B | e5 |
| R 1483 | CHIP RES. | 33k | 1/16W | 5% | RMC1/16S 333JTH | J24189043 | | 1- | B | g4 |
| R 1484 | CHIP RES. | 3.3k | 1/16W | 5% | RMC1/16S 332JTH | J24189031 | | 1- | B | e4 |
| R 1485 | CHIP RES. | 100k | 1/16W | 5% | RMC1/16S 104JTH | J24189049 | | 57- | B | f6 |
| R 1486 | CHIP RES. | 1k | 1/16W | 5% | RMC1/16S 102JTH | J24189025 | | 1- | B | f6 |
| R 1487 | CHIP RES. | 2.2M | 1/16W | 5% | RMC1/16S 225JTH | J24189065 | | 1- | B | g4 |
| R 1488 | CHIP RES. | 3.3k | 1/16W | 5% | RMC1/16S 332JTH | J24189031 | | 1- | B | e4 |
| R 1491 | CHIP RES. | 330k | 1/16W | 5% | RMC1/16S 334JTH | J24189055 | | 1- | B | e4 |
| R 1493 | CHIP RES. | 6.8k | 1/16W | 5% | RMC1/16S 682JTH | J24189035 | | 1- | B | g3 |
| R 1494 | CHIP RES. | 10k | 1/16W | 5% | RMC1/16S 103JTH | J24189037 | | 1- | B | g4 |
| R 1495 | CHIP RES. | 2.2k | 1/16W | 5% | RMC1/16S 222JTH | J24189029 | | 1- | A | D6 |
| R 1496 | CHIP RES. | 470 | 1/16W | 5% | RMC1/16S 471JTH | J24189021 | | 1- | B | e6 |
| R 1497 | CHIP RES. | 100k | 1/16W | 5% | RMC1/16S 104JTH | J24189049 | | 57- | B | e5 |
| R 1498 | CHIP RES. | 47 | 1/16W | 5% | RMC1/16S 470JTH | J24189009 | | 1- | B | d5 |
| R 1499 | CHIP RES. | 470 | 1/16W | 5% | RMC1/16S 471JTH | J24189021 | | 18- | B | b6 |
| R 1500 | CHIP RES. | 100k | 1/16W | 5% | RMC1/16S 104JTH | J24189049 | | 1- | B | b6 |
| R 1500 | CHIP RES. | 470 | 1/16W | 5% | RMC1/16S 471JTH | J24189021 | | 18- | B | b6 |
| R 1501 | CHIP RES. | 470 | 1/16W | 5% | RMC1/16S 471JTH | J24189021 | | 18- | B | b6 |
| R 1502 | CHIP RES. | 470 | 1/16W | 5% | RMC1/16S 471JTH | J24189021 | | 18- | B | b6 |
| R 1503 | CHIP RES. | 470 | 1/16W | 5% | RMC1/16S 471JTH | J24189021 | | 18- | B | b6 |
| R 1504 | CHIP RES. | 470 | 1/16W | 5% | RMC1/16S 471JTH | J24189021 | | 18- | B | b6 |
| R 1505 | CHIP RES. | 4.7k | 1/16W | 5% | RMC1/16S 472JTH | J24189033 | | 1- | B | e7 |
| R 1506 | CHIP RES. | 4.7k | 1/16W | 5% | RMC1/16S 472JTH | J24189033 | | 1- | B | e6 |
| R 1507 | CHIP RES. | 470 | 1/16W | 5% | RMC1/16S 471JTH | J24189021 | | 1- | B | e7 |
| R 1508 | CHIP RES. | 470 | 1/16W | 5% | RMC1/16S 471JTH | J24189021 | | 1- | B | e6 |
| R 1509 | CHIP RES. | 47k | 1/16W | 5% | RMC1/16S 473JTH | J24189045 | | 1 | B | c6 |
| R 1509 | CHIP RES. | 4.7k | 1/16W | 5% | RMC1/16S 472JTH | J24189033 | | 2- | B | c6 |

MAIN Unit

Parts List

| REF | DESCRIPTION | VALUE | V/W | TOL. | MFR'S DESIG | VXSTD P/N | VERS. | LOT | SIDE | LAY ADR |
|--------|-------------|-------|-------|------|-----------------|-----------|-------|------|------|---------|
| R 1510 | CHIP RES. | 15k | 1/16W | 5% | RMC1/16S 153JTH | J24189039 | | 1 | B | c6 |
| R 1510 | CHIP RES. | 1.5k | 1/16W | 5% | RMC1/16S 152JTH | J24189027 | | 2- | B | c6 |
| R 1511 | CHIP RES. | 1 | 1W | 5% | RMC1 1R0JTE | J24305010 | | 1- | B | d7 |
| R 1512 | CHIP RES. | 4.7k | 1/16W | 5% | RMC1/16S 472JTH | J24189033 | | 1- | B | g5 |
| R 1513 | CHIP RES. | 4.7k | 1/16W | 5% | RMC1/16S 472JTH | J24189033 | | 1- | B | f6 |
| R 1514 | CHIP RES. | 470 | 1/16W | 5% | RMC1/16S 471JTH | J24189021 | | 1- | B | g5 |
| R 1515 | CHIP RES. | 470 | 1/16W | 5% | RMC1/16S 471JTH | J24189021 | | 1- | B | f5 |
| R 1516 | CHIP RES. | 4.7k | 1/16W | 5% | RMC1/16S 472JTH | J24189033 | | 1- | B | g7 |
| R 1517 | CHIP RES. | 4.7k | 1/16W | 5% | RMC1/16S 472JTH | J24189033 | | 1- | B | g6 |
| R 1518 | CHIP RES. | 1k | 1/16W | 5% | RMC1/16S 102JTH | J24189025 | | 1- | B | g5 |
| R 1519 | CHIP RES. | 220 | 1/4W | 5% | RMC1/4 221JATP | J24245221 | | 1- | B | d6 |
| R 1520 | CHIP RES. | 4.7 | 1/10W | 5% | RMC1/10T 4R7J | J24205479 | | 1- | B | d6 |
| R 1521 | CHIP RES. | 47 | 1/16W | 5% | RMC1/16S 470JTH | J24189009 | | 1- | B | g6 |
| R 1522 | CHIP RES. | 47 | 1/16W | 5% | RMC1/16S 470JTH | J24189009 | | 1- | B | g7 |
| R 1523 | CHIP RES. | 4.7k | 1/16W | 5% | RMC1/16S 472JTH | J24189033 | | 1- | B | f5 |
| R 1524 | CHIP RES. | 47 | 1/16W | 5% | RMC1/16S 470JTH | J24189009 | | 1- | B | f5 |
| R 1525 | CHIP RES. | 4.7 | 1/10W | 5% | RMC1/10T 4R7J | J24205479 | | 1- | B | d7 |
| R 1526 | CHIP RES. | 1.5k | 1/16W | 5% | RMC1/16S 152JTH | J24189027 | | 1- | B | g5 |
| R 1527 | CHIP RES. | 47 | 1/16W | 5% | RMC1/16S 470JTH | J24189009 | | 1- | B | g5 |
| R 1528 | CHIP RES. | 220 | 1/16W | 5% | RMC1/16S 221JTH | J24189017 | | 1- | B | d7 |
| R 1530 | CHIP RES. | 0 | 1/10W | 5% | RMC1/10T 000J | J24205000 | | 1-17 | | |
| R 1531 | CHIP RES. | 0 | 1/10W | 5% | RMC1/10T 000J | J24205000 | | 1-17 | | |
| R 1533 | CHIP RES. | 2.2k | 1/16W | 5% | RMC1/16S 222JTH | J24189029 | | 1- | B | g6 |
| R 1533 | CHIP RES. | 4.7k | 1/16W | 5% | RMC1/16S 472JTH | J24189033 | | 76- | B | g6 |
| R 1534 | CHIP RES. | 47 | 1/16W | 5% | RMC1/16S 470JTH | J24189009 | | 1- | B | g6 |
| R 1535 | CHIP RES. | 470 | 1/16W | 5% | RMC1/16S 471JTH | J24189021 | | 1- | B | b6 |
| R 1537 | CHIP RES. | 10k | 1/16W | 5% | RMC1/16S 103JTH | J24189037 | | 1- | B | g6 |
| R 1538 | CHIP RES. | 470 | 1/4W | 5% | RMC1/4 471JATP | J24245471 | | 1- | B | h3 |
| R 1539 | CHIP RES. | 470 | 1/16W | 5% | RMC1/16S 471JTH | J24189021 | | 1- | B | b7 |
| R 1541 | CHIP RES. | 15k | 1/16W | 5% | RMC1/16S 153JTH | J24189039 | | 1- | B | b6 |
| R 1542 | CHIP RES. | 220 | 1/16W | 5% | RMC1/16S 221JTH | J24189017 | | 1- | A | D7 |
| R 1543 | CHIP RES. | 470 | 1/16W | 5% | RMC1/16S 471JTH | J24189021 | | 1- | B | b7 |
| R 1544 | CHIP RES. | 470 | 1/16W | 5% | RMC1/16S 471JTH | J24189021 | | 1- | A | G5 |
| R 1545 | CHIP RES. | 470 | 1/16W | 5% | RMC1/16S 471JTH | J24189021 | | 1- | A | G5 |
| R 1546 | CHIP RES. | 150k | 1/16W | 5% | RMC1/16S 154JTH | J24189051 | | 1- | B | b6 |
| R 1547 | CHIP RES. | 68k | 1/16W | 5% | RMC1/16S 683JTH | J24189047 | | 1- | B | b7 |
| R 1548 | CHIP RES. | 470 | 1/16W | 5% | RMC1/16S 471JTH | J24189021 | | 1- | A | G5 |
| R 1549 | CHIP RES. | 470 | 1/16W | 5% | RMC1/16S 471JTH | J24189021 | | 1- | A | G5 |
| R 1550 | CHIP RES. | 0 | 1/16W | 5% | RMC1/16 000JATP | J24185000 | | 1- | A | G6 |
| R 1551 | CHIP RES. | 10k | 1/16W | 5% | RMC1/16S 103JTH | J24189037 | | 1- | B | h5 |
| R 1552 | CHIP RES. | 10k | 1/16W | 5% | RMC1/16S 103JTH | J24189037 | | 1- | B | b7 |
| R 1553 | CHIP RES. | 220 | 1/16W | 5% | RMC1/16S 221JTH | J24189017 | | 1- | B | h3 |
| R 1554 | CHIP RES. | 220 | 1/16W | 5% | RMC1/16S 221JTH | J24189017 | | 1- | B | h4 |
| R 1555 | CHIP RES. | 1k | 1/16W | 5% | RMC1/16S 102JTH | J24189025 | | 1- | B | h3 |
| R 1556 | CHIP RES. | 0 | 1/16W | 5% | RMC1/16 000JATP | J24185000 | | 1- | A | E6 |
| R 1557 | CHIP RES. | 1k | 1/16W | 5% | RMC1/16S 102JTH | J24189025 | | 1- | B | h5 |
| R 1558 | CHIP RES. | 1k | 1/16W | 5% | RMC1/16S 102JTH | J24189025 | | 1- | B | h5 |
| R 1559 | CHIP RES. | 1k | 1/16W | 5% | RMC1/16S 102JTH | J24189025 | | 1- | B | h4 |
| R 1560 | CHIP RES. | 1k | 1/16W | 5% | RMC1/16S 102JTH | J24189025 | | 1- | B | h3 |
| R 1561 | CHIP RES. | 1k | 1/16W | 5% | RMC1/16S 102JTH | J24189025 | | 1- | B | h4 |
| R 1562 | CHIP RES. | 1k | 1/16W | 5% | RMC1/16S 102JTH | J24189025 | | 1- | B | h4 |
| R 1563 | CHIP RES. | 1k | 1/16W | 5% | RMC1/16S 102JTH | J24189025 | | 1- | B | h5 |
| R 1565 | CHIP RES. | 1k | 1/16W | 5% | RMC1/16S 102JTH | J24189025 | | 1- | B | h6 |
| R 1566 | CHIP RES. | 1k | 1/16W | 5% | RMC1/16S 102JTH | J24189025 | | 1- | B | h6 |
| R 1567 | CHIP RES. | 1k | 1/16W | 5% | RMC1/16S 102JTH | J24189025 | | 1- | A | A3 |
| R 1568 | CHIP RES. | 1k | 1/16W | 5% | RMC1/16S 102JTH | J24189025 | | 1- | B | h5 |
| R 1569 | CHIP RES. | 470 | 1/16W | 5% | RMC1/16S 471JTH | J24189021 | | 1- | B | a7 |
| R 1570 | CHIP RES. | 470 | 1/16W | 5% | RMC1/16S 471JTH | J24189021 | | 1- | B | a7 |
| R 1571 | CHIP RES. | 1k | 1/16W | 5% | RMC1/16S 102JTH | J24189025 | | 1- | A | G6 |
| R 1572 | CHIP RES. | 0 | 1/16W | 5% | RMC1/16S JPTH | J24189070 | | 1- | B | a6 |
| R 1573 | CHIP RES. | 1k | 1/16W | 5% | RMC1/16S 102JTH | J24189025 | | 1- | B | a7 |
| R 1576 | CHIP RES. | 0 | 1/10W | 5% | RMC1/10T 000J | J24205000 | | 1-17 | | |
| R 1577 | CHIP RES. | 3.9 | 1/2W | 5% | RMC1/2 3R9JATP | J24275399 | | 1- | B | h7 |
| R 1578 | CHIP RES. | 1.5k | 1/16W | 5% | RMC1/16S 152JTH | J24189027 | | 1- | B | e5 |
| R 1579 | CHIP RES. | 47k | 1/16W | 5% | RMC1/16S 473JTH | J24189045 | | 1- | A | D6 |
| R 1580 | CHIP RES. | 1.5k | 1/16W | 5% | RMC1/16S 152JTH | J24189027 | | 1- | B | g5 |
| R 1581 | CHIP RES. | 10k | 1/16W | 5% | RMC1/16S 103JTH | J24189037 | | 1- | A | A5 |
| R 1582 | CHIP RES. | 4.7k | 1/16W | 5% | RMC1/16S 472JTH | J24189033 | | 1- | A | A4 |
| R 1583 | CHIP RES. | 4.7k | 1/16W | 5% | RMC1/16S 472JTH | J24189033 | | 1- | B | h4 |
| R 1584 | CHIP RES. | 10k | 1/16W | 5% | RMC1/16S 103JTH | J24189037 | | 1- | B | h4 |
| R 1585 | CHIP RES. | 10k | 1/16W | 5% | RMC1/16S 103JTH | J24189037 | | 1- | A | B3 |
| R 1586 | CHIP RES. | 4.7k | 1/16W | 5% | RMC1/16S 472JTH | J24189033 | | 1- | A | B3 |
| R 1587 | CHIP RES. | 2.2M | 1/16W | 5% | RMC1/16S 225JTH | J24189065 | | 1- | B | h3 |

MAIN Unit

Parts List

| REF | DESCRIPTION | VALUE | V/W | TOL. | MFR'S DESIG | VXSTD P/N | VERS. | LOT | SIDE | LAY ADR |
|--------|---------------|-------|-------|------|------------------|-----------|-------|-------|------|---------|
| R 1588 | CHIP RES. | 10k | 1/16W | 5% | RMC1/16S 103JTH | J24189037 | | 1- | B | g4 |
| R 1589 | CHIP RES. | 470 | 1/16W | 5% | RMC1/16 471JATP | J24185471 | | 1- | A | D2 |
| R 1590 | CHIP RES. | 15k | 1/16W | 5% | RMC1/16S 153JTH | J24189039 | | 1- | A | B4 |
| R 1591 | CHIP RES. | 330 | 1/16W | 5% | RMC1/16S 331JTH | J24189019 | | 1-66 | B | f4 |
| R 1592 | CHIP RES. | 0 | 1/16W | 5% | RMC1/16S JPTH | J24189070 | | 18- | B | b7 |
| R 1593 | CHIP RES. | 0 | 1/16W | 5% | RMC1/16S JPTH | J24189070 | | 18- | B | b7 |
| R 1594 | CHIP RES. | 4.7k | 1/16W | 5% | RMC1/16S 472JTH | J24189033 | | 1- | B | b6 |
| R 1595 | CHIP RES. | 6.8 | 1/10W | 5% | RMC1/10T 6R8J | J24205689 | | 1 | B | c7 |
| R 1595 | CHIP RES. | 15 | 1/10W | 5% | RMC1/10T 150J | J24205150 | | 2- | B | c7 |
| R 1595 | CHIP RES. | 15 | 1/4W | 5% | RMC1/4 150JATP | J24245150 | | 18- | B | c7 |
| R 1596 | CHIP RES. | 10k | 1/16W | 5% | RMC1/16S 103JTH | J24189037 | | 1- | B | f3 |
| R 1597 | CHIP RES. | 4.7 | 1/16W | 5% | RMC1/16 4R7JATP | J24185479 | | 1- | B | b2 |
| R 1597 | CHIP RES. | 12 | 1/16W | 5% | RMC1/16 120JATP | J24185120 | | 4- | B | b2 |
| R 1597 | CHIP RES. | 27 | 1/16W | 5% | RMC1/16 270JATP | J24185270 | | 14-17 | B | b2 |
| R 1599 | CHIP RES. | 220 | 1/16W | 5% | RMC1/16S 221JTH | J24189017 | | 1- | B | d4 |
| R 1599 | CHIP RES. | 120 | 1/16W | 5% | RMC1/16S 121JTH | J24189014 | | 18- | B | d4 |
| R 1600 | CHIP RES. | 220k | 1/16W | 5% | RMC1/16S 224JTH | J24189053 | | 1- | B | f4 |
| R 1601 | CHIP RES. | 10k | 1/16W | 5% | RMC1/16S 103JTH | J24189037 | | 1- | B | c2 |
| R 1602 | CHIP RES. | 0 | 1/16W | 5% | RMC1/16S JPTH | J24189070 | | 1- | A | F5 |
| R 1603 | CHIP RES. | 68k | 1/16W | 5% | RMC1/16S 683JTH | J24189047 | | 1- | B | e2 |
| R 1603 | CHIP RES. | 33k | 1/16W | 5% | RMC1/16S 333JTH | J24189043 | | 4- | B | e2 |
| R 1603 | CHIP RES. | 68k | 1/16W | 5% | RMC1/16S 683JTH | J24189047 | | 29- | B | e2 |
| R 1603 | CHIP RES. | 47k | 1/16W | 5% | RMC1/16S 473JTH | J24189045 | | 34- | B | e2 |
| R 1604 | CHIP RES. | 1M | 1/16W | 5% | RMC1/16S 105JTH | J24189061 | | 1- | B | e2 |
| R 1604 | CHIP RES. | 100k | 1/16W | 5% | RMC1/16S 104JTH | J24189049 | | 18- | B | e2 |
| R 1605 | CHIP RES. | 10k | 1/16W | 5% | RMC1/16S 103JTH | J24189037 | | 1- | B | d5 |
| R 1606 | CHIP RES. | 10k | 1/16W | 5% | RMC1/16S 103JTH | J24189037 | | 1- | A | F5 |
| R 1609 | CHIP RES. | 2.2k | 1/16W | 5% | RMC1/16S 222JTH | J24189029 | | 1- | A | E3 |
| R 1610 | CHIP RES. | 68k | 1/16W | 5% | RMC1/16S 683JTH | J24189047 | | 1- | B | f4 |
| R 1611 | CHIP RES. | 220 | 1/16W | 5% | RMC1/16S 221JTH | J24189017 | | 1- | A | E3 |
| R 1612 | CHIP RES. | 100k | 1/16W | 5% | RMC1/16S 104JTH | J24189049 | | 1- | A | G7 |
| R 1613 | CHIP RES. | 470 | 1/16W | 5% | RMC1/16S 471JTH | J24189021 | | 1- | B | a7 |
| R 1614 | CHIP RES. | 100k | 1/16W | 5% | RMC1/16S 104JTH | J24189049 | | 1- | A | G5 |
| R 1617 | CHIP RES. | 10k | 1/16W | 5% | RMC1/16S 103JTH | J24189037 | | 1- | A | G5 |
| R 1618 | CHIP RES. | 10k | 1/16W | 5% | RMC1/16S 103JTH | J24189037 | | 1- | A | G7 |
| R 1619 | CHIP RES. | 0 | 1/16W | 5% | RMC1/16S JPTH | J24189070 | | 1- | B | d5 |
| R 1620 | CHIP RES. | 0 | 1/16W | 5% | RMC1/16S JPTH | J24189070 | | 1- | B | d5 |
| R 1621 | CHIP RES. | 0 | 1/16W | 5% | RMC1/16S JPTH | J24189070 | | 1- | B | c6 |
| R 1622 | CHIP RES. | 10k | 1/16W | 5% | RMC1/16S 103JTH | J24189037 | | 1- | A | F5 |
| R 1623 | CHIP RES. | 10k | 1/16W | 5% | RMC1/16S 103JTH | J24189037 | | 1- | A | F5 |
| R 1624 | CHIP RES. | 10k | 1/16W | 5% | RMC1/16S 103JTH | J24189037 | | 1- | A | F5 |
| R 1625 | CHIP RES. | 100k | 1/16W | 5% | RMC1/16S 104JTH | J24189049 | | 1- | B | c6 |
| R 1630 | CHIP RES. | 4.7k | 1/16W | 5% | RMC1/16S 472JTH | J24189033 | | 1- | A | G5 |
| R 1631 | CHIP RES. | 100k | 1/16W | 5% | RMC1/16S 104JTH | J24189049 | | 1- | A | H5 |
| R 1632 | CHIP RES. | 100 | 1/16W | 5% | RMC1/16S 101JTH | J24189013 | | 18- | B | b6 |
| R 1633 | CHIP RES. | 18k | 1/16W | 5% | RMC1/16S 183JTH | J24189040 | | 1-17 | B | d5 |
| R 1634 | CHIP RES. | 10k | 1/16W | 5% | RMC1/16S 103JTH | J24189037 | | 1-17 | B | d5 |
| R 1635 | CHIP RES. | 1k | 1/16W | 5% | RMC1/16S 102JTH | J24189025 | | 18- | B | c6 |
| R 1638 | CHIP RES. | 220k | 1/16W | 5% | RMC1/16S 224JTH | J24189053 | | 18- | B | e4 |
| R 1639 | CHIP RES. | 220k | 1/16W | 5% | RMC1/16S 224JTH | J24189053 | | 18- | B | g5 |
| R 1640 | CHIP RES. | 220k | 1/16W | 5% | RMC1/16S 224JTH | J24189053 | | 18- | B | g5 |
| R 1641 | CHIP RES. | 3.9k | 1/16W | 5% | RMC1/16 392JATP | J24185392 | | 18- | B | c2 |
| R 1641 | CHIP RES. | 2.2k | 1/16W | 5% | RMC1/16 222JATP | J24185222 | | 29- | B | c2 |
| R 1642 | CHIP RES. | 100 | 1/16W | 5% | RMC1/16S 101JTH | J24189013 | | 40- | B | e3 |
| R 1643 | CHIP RES. | 0 | 1/16W | 5% | RMC1/16S JPTH | J24189070 | | 40- | B | d1 |
| R 1643 | CHIP RES. | 15 | 1/16W | 5% | RMC1/16S 150JTH | J24189003 | | 67- | B | d1 |
| R 1644 | CHIP RES. | 0 | 1/16W | 5% | RMC1/16S JPTH | J24189070 | | 40- | B | d1 |
| R 1644 | CHIP RES. | 15 | 1/16W | 5% | RMC1/16S 150JTH | J24189003 | | 67- | B | d1 |
| R 1645 | CHIP RES. | 82 | 1/16W | 5% | RMC1/16S 820JTH | J24189012 | | 67- | B | d1 |
| R 1646 | CHIP RES. | 100k | 1/16W | 5% | RMC1/16S 104JTH | J24189049 | | 57- | | |
| R 1647 | CHIP RES. | 470k | 1/16W | 5% | RMC1/16 474JATP | J24185474 | | 57- | | |
| R 1648 | CHIP RES. | 33k | 1/16W | 5% | RMC1/16S 333JTH | J24189043 | | 73- | | |
| R 1649 | CHIP RES. | 0 | 1/8W | 5% | RMC1/8T 000J | J24215000 | | 73-74 | | |
| R 1649 | CHIP RES. | 3.9k | 1/16W | 5% | RMC1/16S 392JTH | J24189032 | | 79- | | |
| R 1650 | CHIP RES. | 47k | 1/16W | 5% | RMC1/16S 473JTH | J24189045 | | 79- | | |
| RB1002 | BLOCK RES. | 10k | | | SR4E103JT | J42900027 | | 1- | A | F5 |
| RB1003 | BLOCK RES. | 10k | | | SR4E103JT | J42900027 | | 1- | B | g6 |
| RL1001 | RELAY | | DC12V | | G5V-1 DC12V | M1190120 | | 1- | A | D7 |
| S 1001 | SLIDE SWITCH | | | | SSSS22 | N6090057 | | 1- | A | F2 |
| S 1002 | SLIDE SWITCH | | | | SSSS22 | N6090057 | | 1-17 | A | G7 |
| T 1001 | COIL PWR-WIDE | | | | A0898 | L0022552 | | 1- | A | H5 |
| T 1002 | COIL PWR-WIDE | | | | 3A TR9.3X4.8X5.0 | L0022642A | | 1- | A | G4 |
| T 1002 | COIL PWR-WIDE | | | | ESD-R-10D | L0022847 | | 14- | A | G4 |

MAIN Unit

Parts List

| REF | DESCRIPTION | VALUE | V/W | TOL. | MFR'S DESIG | VXSTD P/N | VERS. | LOT | SIDE | LAY ADR |
|--------|-----------------------------------------------------------------|------------|-----|------|-------------------|---------------------------------------------------------------|-------|----------------------------------|------|---------|
| T 1003 | COIL PWR-WIDE | | | | 3A6 RIB8X14X6.5 | L0022641A | | 1- | A | H2 |
| T 1004 | COIL 05RF | | | | 100M 010812300A | L0022779 | | 1- | A | E4 |
| T 1005 | COIL 05RF | | | | 100M 010812300A | L0022779 | | 1- | A | E3 |
| T 1006 | COIL 05RF | | | | 100M 010812300A | L0022779 | | 1- | A | F3 |
| T 1007 | COIL WIDE-TRANS. | | | | 3-318707 | L0022619 | | 1- | A | E3 |
| T 1008 | COIL 05RF | | | | 100M 010812300A | L0022779 | | 1- | A | E2 |
| T 1009 | COIL 05RF | | | | 100M 010812300A | L0022779 | | 1- | A | F3 |
| T 1010 | COIL 05RF | | | | 100M 010812300A | L0022779 | | 1- | A | F2 |
| T 1011 | COIL 05RF | | | | 100M 010812300A | L0022779 | | 1- | A | E1 |
| T 1012 | COIL 05RF | | | | 100M 010812300A | L0022779 | | 1- | A | E1 |
| T 1013 | COIL 05RF | | | | 100M 010812300A | L0022779 | | 1- | A | D1 |
| T 1014 | COIL 05RF | | | | 74.62M 010812302 | L0022781 | | 1- | A | C3 |
| T 1015 | BALUN TRANSFORMERS | | | | #458DB-1616=P3 | L0190246 | | 1- | A | D1 |
| T 1016 | BALUN TRANSFORMERS | | | | #458DB-1616=P3 | L0190246 | | 1- | A | D2 |
| T 1017 | COIL WIDE-TRANS. | | | | 3-317611 | L0022478 | | 1- | A | E2 |
| T 1018 | COIL 05RF | | | | 74.62M 010812302 | L0022781 | | 1- | A | B3 |
| T 1018 | COIL 05RF | | | | 74.62M 010812303 | L0022782 | | 18- | A | B3 |
| T 1019 | COIL 05RF | | | | 74.62M 010812302 | L0022781 | | 1- | A | B3 |
| T 1020 | COIL WIDE-TRANS. | | | | 3-317610 | L0022479 | | 1- | A | D2 |
| T 1021 | COIL 05RF | | | | 74.62M 010812302 | L0022781 | | 1- | A | D2 |
| T 1022 | COIL WIDE-TRANS. | | | | 3-317611 | L0022478 | | 1- | A | D2 |
| T 1023 | COIL 05RF | | | | 74.62M 010812303 | L0022782 | | 1- | A | D3 |
| T 1023 | COIL 05RF | 74.62MHz | | | 74.62M 030812396C | L0022854 | | 18- | A | D3 |
| T 1024 | COIL 05RF | | | | 74.62M 010812303 | L0022782 | | 1- | A | D3 |
| T 1024 | COIL 05RF | 74.62MHz | | | 74.62M 030812396C | L0022854 | | 18- | A | D3 |
| T 1025 | COIL 05RF | 455kHz | | | 455K 030812470 | L0022778 | | 1- | A | A3 |
| T 1026 | COIL 05RF | | | | 74.62M 010812303 | L0022782 | | 1- | A | D4 |
| T 1026 | COIL 05RF | 74.62MHz | | | 74.62M 030812396C | L0022854 | | 18- | A | D4 |
| T 1027 | COIL 05RF | 455kHz | | | 455K 030812471 | L0022780 | | 1- | A | D5 |
| T 1028 | COIL 05RF | | | | 50M 010812304 | L0022783 | | 1- | A | D4 |
| T 1029 | COIL 05RF | 455kHz | | | 455K 030812470 | L0022778 | | 1- | A | B4 |
| T 1030 | COIL 05RF | | | | 74.62M 010812302 | L0022781 | | 1- | A | D5 |
| T 1031 | COIL 05RF | 455kHz | | | 455K 030812471 | L0022780 | | 1- | A | D5 |
| T 1032 | COIL WIDE-TRANS. | | | | 3-317611 | L0022478 | | 1- | A | C5 |
| T 1033 | COIL 05RF | 455kHz | | | 455K 030812470 | L0022778 | | 1- | A | C4 |
| T 1034 | COIL 05RF | 455kHz | | | 455K 030812471 | L0022780 | | 1- | A | B5 |
| T 1035 | COIL 05RF | 455kHz | | | 455K 030812470 | L0022778 | | 1- | A | C5 |
| T 1036 | COIL 05RF | 455kHz | | | 455K 030812471 | L0022780 | | 1- | A | C5 |
| T 1037 | COIL 05RF | 455kHz | | | 455K 030812471 | L0022780 | | 1- | A | D5 |
| TC1001 | TRIMMER CAP. | 3pF | | | ECR-KN003A61X 3P | K91000264 | | 1- | A | E4 |
| TC1002 | TRIMMER CAP. | 6pF | | | ECR-KN006A61X 6P | K91000225 | | 1- | A | E1 |
| TC1003 | TRIMMER CAP. | 6pF | | | ECR-KN006A61X 6P | K91000225 | | 1- | A | E1 |
| TC1004 | TRIMMER CAP. | 6pF | | | ECR-KN006A61X 6P | K91000225 | | 1- | A | D1 |
| TC1005 | TRIMMER CAP. | 10pF | | | ECR-KN010C61X | K91000226 | | 1- | A | E2 |
| TH1001 | THERMISTOR | | | | TBPS1R223K460H5Q | G9090085 | | 1- | B | a2 |
| VR1001 | POT. | 1k | | | EVN-5ESX50B13 | J51811102 | | 1- | A | G3 |
| VR1002 | POT. | 1k | | | EVN-5ESX50B13 | J51811102 | | 1- | A | H3 |
| VR1003 | POT. | 2.2k | | | EVN-5ESX50BE3 | J51811222 | | 1- | A | G2 |
| VR1004 | POT. | 2.2k | | | EVN-5ESX50BE3 | J51811222 | | 1- | A | F2 |
| VR1005 | POT. | 10k | | | EVN-5ESX50B14 | J51811103 | | 1- | A | B4 |
| X 1001 | XTAL TSS-6035B | 19.82MHz | | | 19.820MHZ | H0103262 | | 1- | A | G5 |
| X 1001 | XTAL TSS-6035B | 19.82MHz | | | 19.820MHZ | H0103262A | | 55- | A | G5 |
| X 1002 | XTAL TSS-7050A | 22.7785MHz | | | 22.7785MHZ | H0103277 | | 1- | B | f3 |
| X 1002 | XTAL TSS-7050A-2 | 22778.5kHz | | | 22778.5KHz | H0103277A | | 39- | B | f3 |
| X 1003 | XTAL TSS-7050A | 8.23MHz | | | 8.230MHZ | H0103261 | | 18- | B | b6 |
| XF1001 | XTAL FILTER | | | | MF68Q TR-6(3) | H1102349 | | 1- | A | D3 |
| XF1001 | XTAL FILTER | | | | MFT68Q 68.33MHZ | H1102372 | | 18- | A | D3 |
| | HEATSINK PLATE SHIELD CASE SHIELD SHEET SHEET SHEET | | | | (MIXER) | RA0416500 RA0439400 RA0459300 RA0638900 RA0638900 | | 1- 1- 1- 32-39 32-39 | B | a3 |

MAIN Unit

Note

PLL Unit (Lot 1 ~ 11)

Circuit Diagram

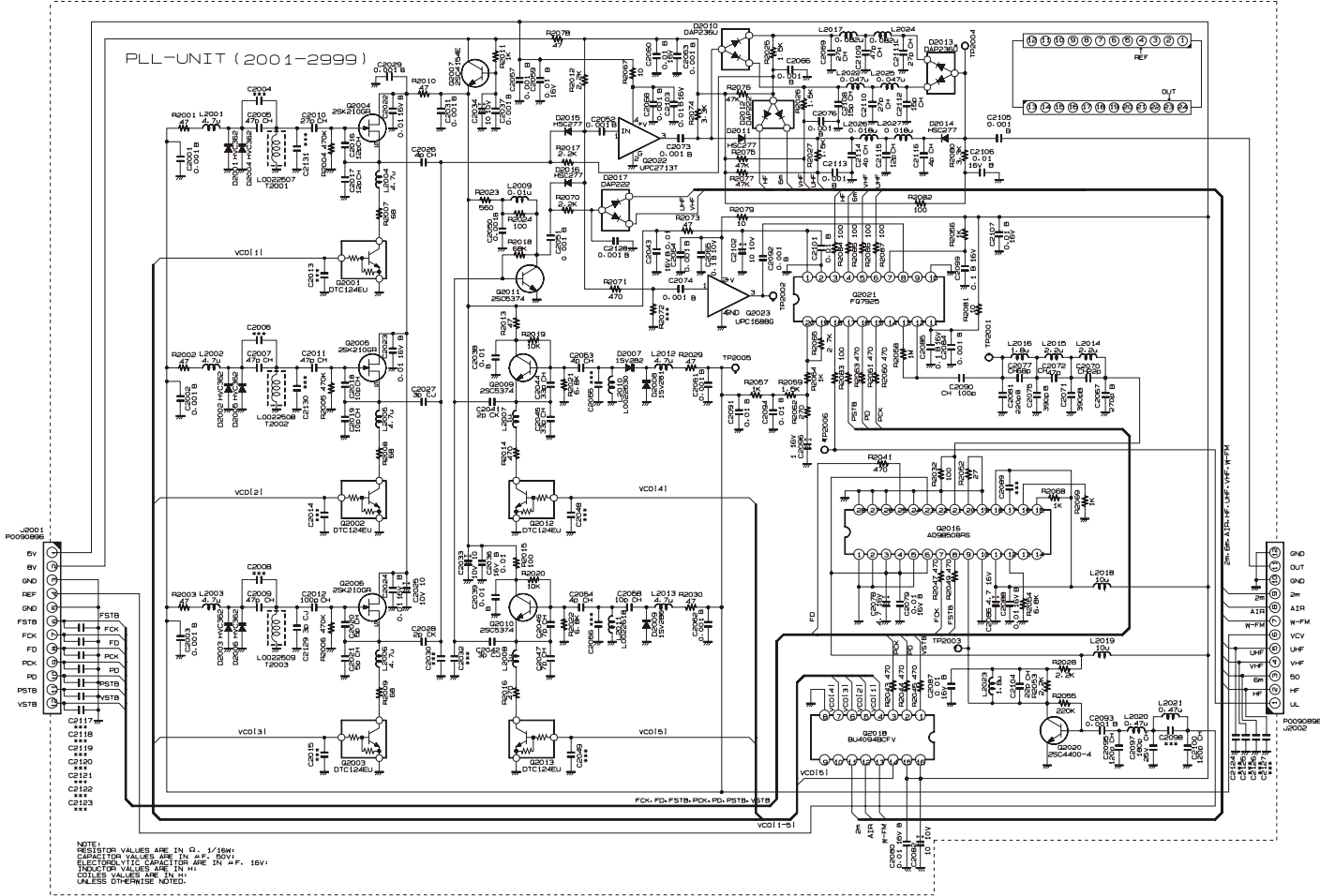

PLL Unit (Lot 1 ~ 11)

Parts Layout

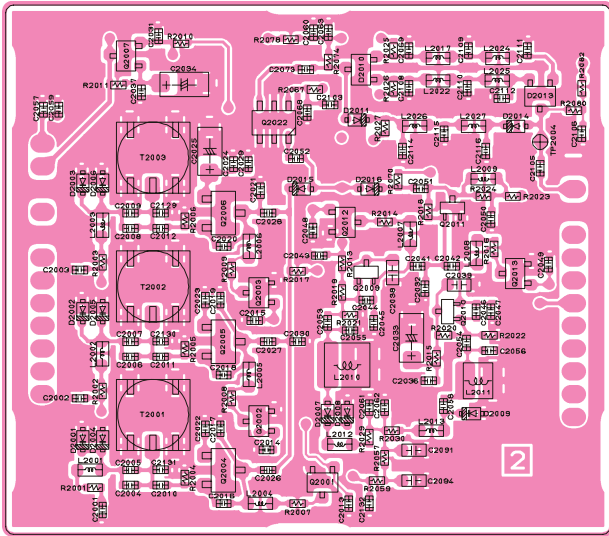

Side A

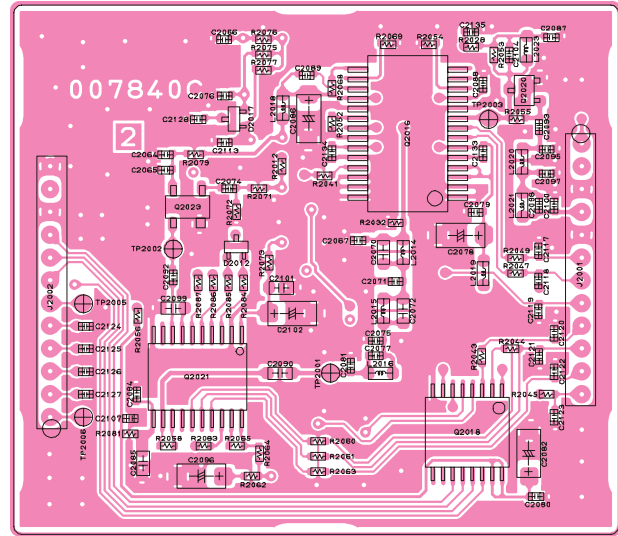

Side B

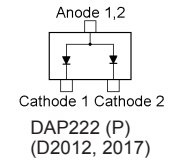
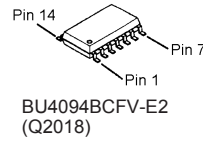
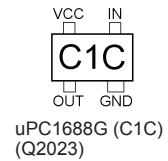
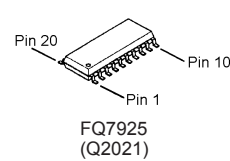
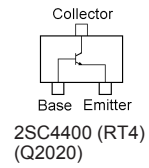
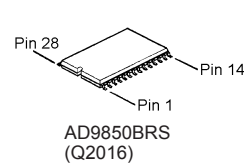
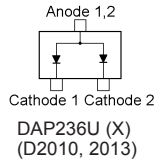
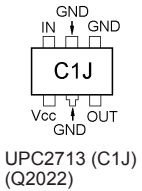
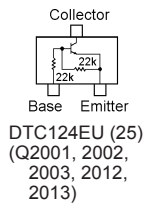
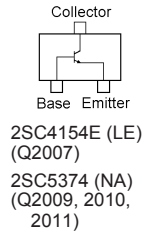
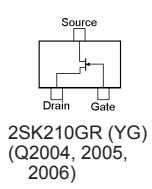

PLL Unit (Lot 12 ~ 65)

Parts Layout

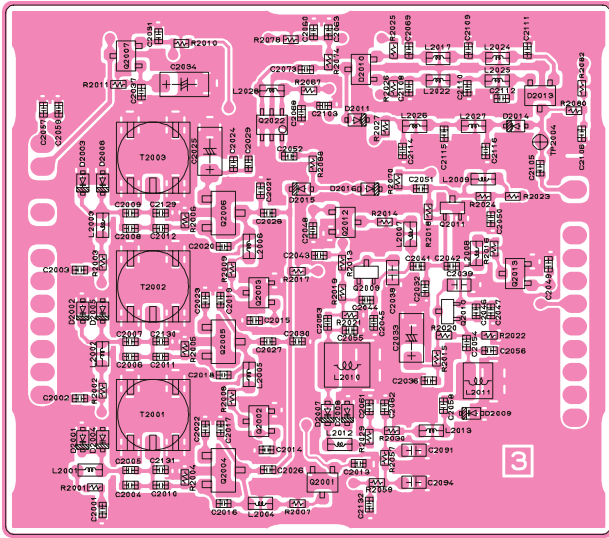

Side A

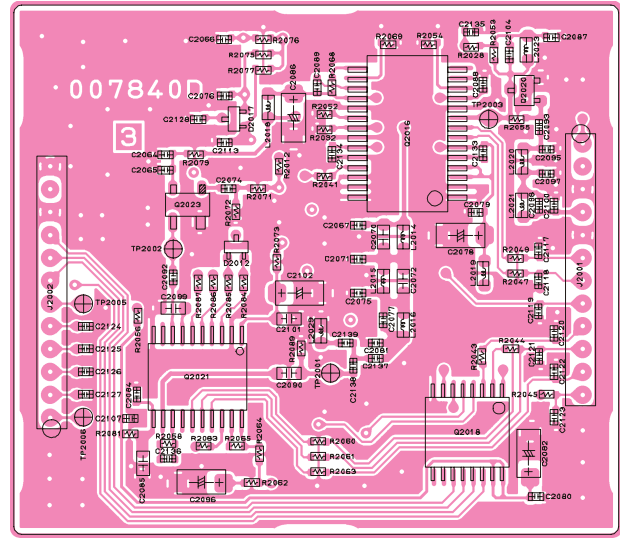

Side B

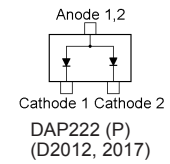
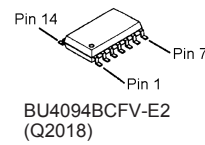
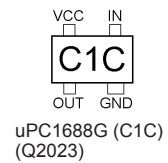
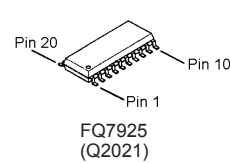
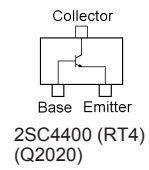
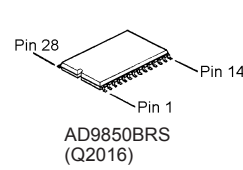
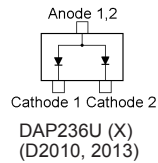
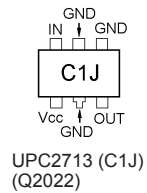
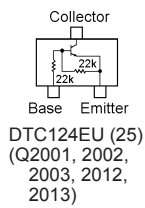
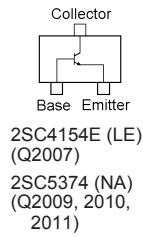
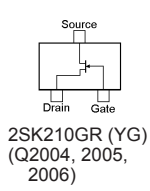

PLL Unit (Lot 66 ~)

Circuit Diagram

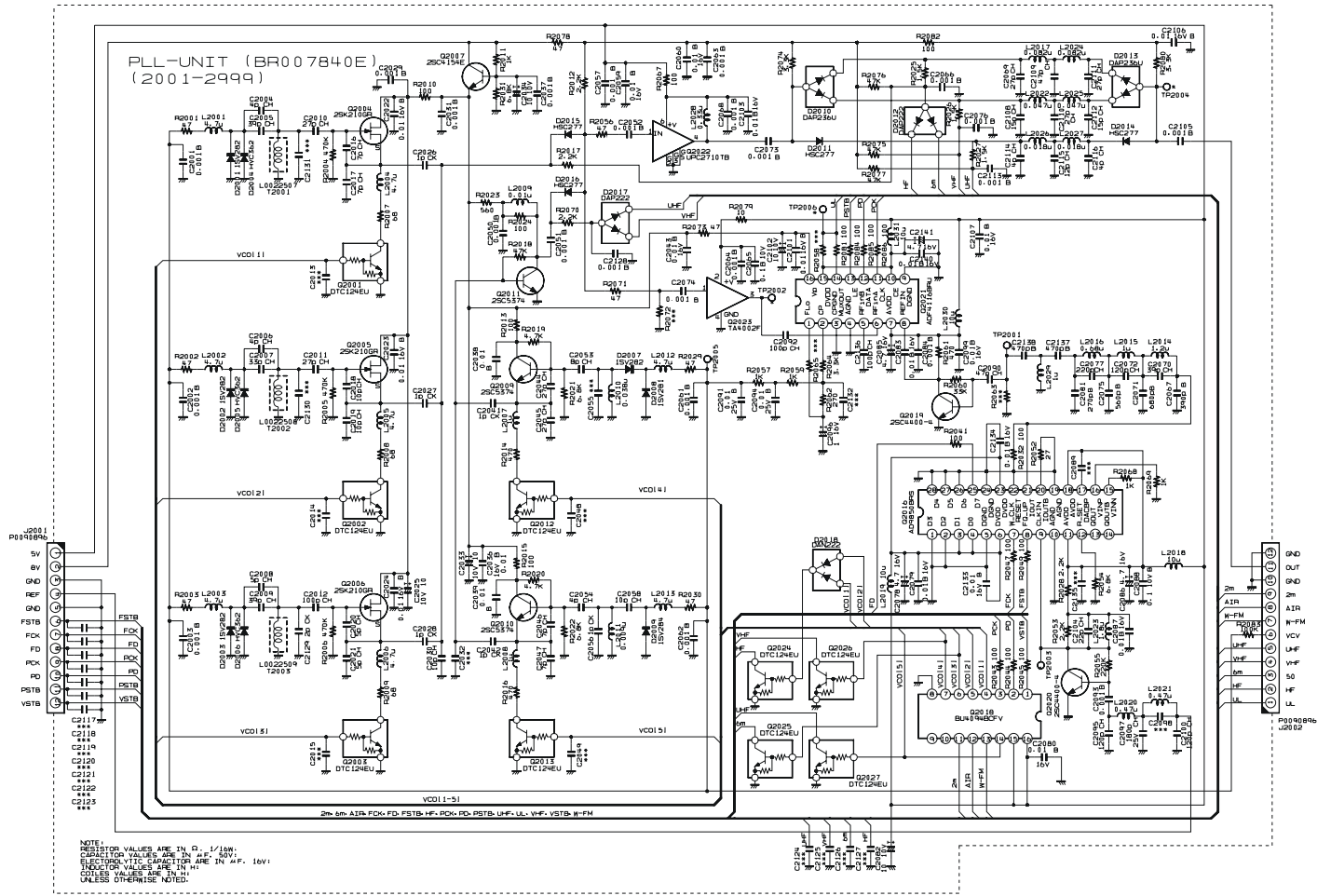

PLL Unit (Lot 66 ~)

Parts Layout

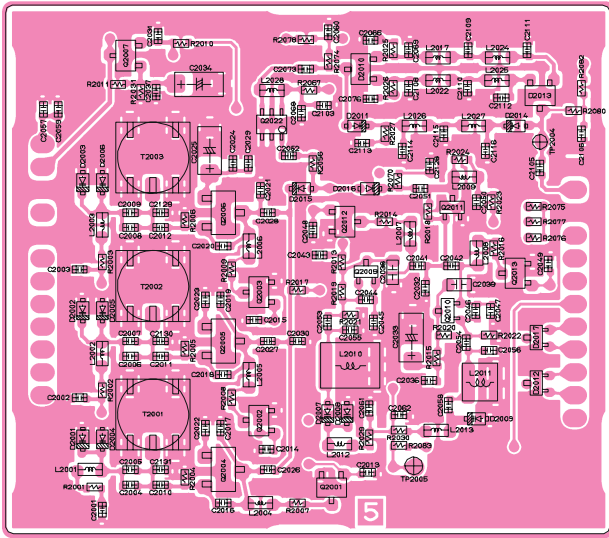

Side A

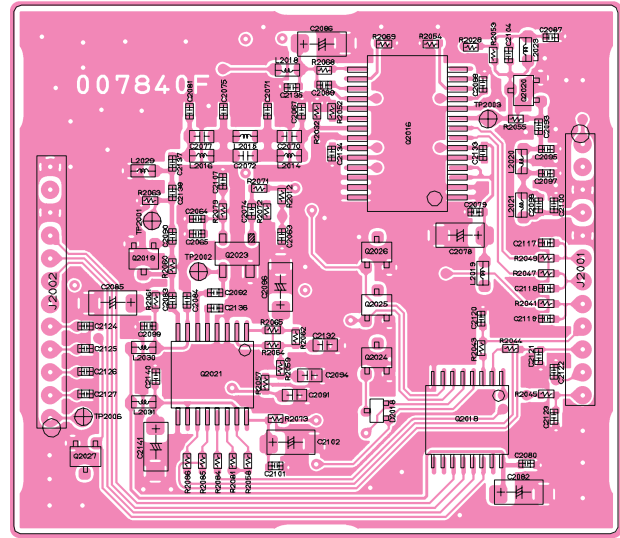

Side B

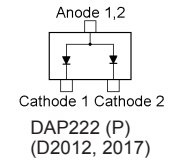
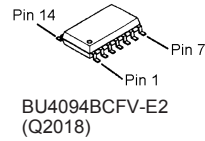
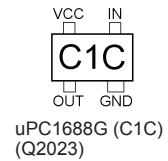
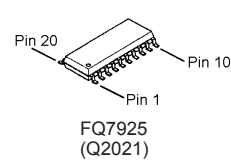
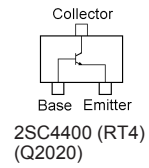
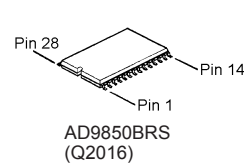
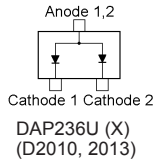
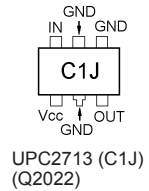
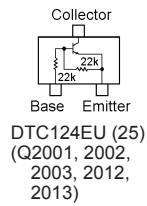
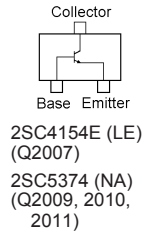
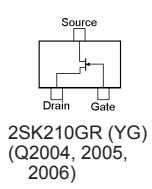

| REF | DESCRIPTION | VALUE | V/W | TOL. | MFR'S DESIG | VXSTD P/N | VERS. | LOT | SIDE | LAY ADR | |
|-----------------------|--------------|---------|-----|------|--------------------|-----------|-----------|-------|-------|---------|--|
| PCB with Components | | | | | | CB1229001 | | | | | |
| Printed Circuit Board | | | | | | AH007M000 | FR007840C | | 1- | | |
| | | | | | | AH007M000 | FR007840D | | 12-65 | | |
| | | | | | | AH007M000 | FR007840F | | 66- | | |
| C 2001 | CHIP CAP. | 0.001uF | 50V | B | UMK105B102KW-F | K22178829 | | 1- | A | A2 | |
| C 2001 | CHIP CAP. | 0.001uF | 50V | B | GRM155B11H102KA01D | K22178809 | | 66- | A | A2 | |
| C 2002 | CHIP CAP. | 0.001uF | 50V | B | UMK105B102KW-F | K22178829 | | 1- | A | A2 | |
| C 2002 | CHIP CAP. | 0.001uF | 50V | B | GRM155B11H102KA01D | K22178809 | | 66- | A | A2 | |
| C 2003 | CHIP CAP. | 0.001uF | 50V | B | UMK105B102KW-F | K22178829 | | 1- | A | A1 | |
| C 2003 | CHIP CAP. | 0.001uF | 50V | B | GRM155B11H102KA01D | K22178809 | | 66- | A | A1 | |
| C 2004 | CHIP CAP. | 4pF | 50V | CH | UMK105CH040CV-F | K22178252 | | 8- | A | A2 | |
| C 2004 | CHIP CAP. | 4pF | 50V | CH | UMK105CH040CV-F | K22178252 | | 66- | A | A2 | |
| C 2005 | CHIP CAP. | 47pF | 50V | CH | UMK105CH470JV-F | K22178274 | | 1- | A | A2 | |
| C 2005 | CHIP CAP. | 39pF | 50V | CH | UMK105CH390JV-F | K22178272 | | 8- | A | A2 | |
| C 2005 | CHIP CAP. | 27pF | 50V | CH | GRM1552C1H270JZ01D | K22178222 | | 66- | A | A2 | |
| C 2006 | CHIP CAP. | 4pF | 50V | CH | UMK105CH040CV-F | K22178252 | | 8- | A | A2 | |
| C 2006 | CHIP CAP. | 3pF | 50V | CJ | UMK105CJ030CV-F | K22178251 | | 66- | A | A2 | |
| C 2007 | CHIP CAP. | 47pF | 50V | CH | UMK105CH470JV-F | K22178274 | | 1- | A | A2 | |
| C 2007 | CHIP CAP. | 33pF | 50V | CH | UMK105CH330JV-F | K22178270 | | 8- | A | A2 | |
| C 2007 | CHIP CAP. | 27pF | 50V | CH | GRM1552C1H270JZ01D | K22178222 | | 66- | A | A2 | |
| C 2008 | CHIP CAP. | 4pF | 50V | CH | UMK105CH040CV-F | K22178252 | | 8- | A | A1 | |
| C 2008 | CHIP CAP. | 5pF | 50V | CH | UMK105CH050CV-F | K22178253 | | 51-65 | A | A1 | |
| C 2009 | CHIP CAP. | 47pF | 50V | CH | UMK105CH470JV-F | K22178274 | | 1- | A | A1 | |
| C 2009 | CHIP CAP. | 39pF | 50V | CH | UMK105CH390JV-F | K22178272 | | 8- | A | A1 | |
| C 2009 | CHIP CAP. | 33pF | 50V | CH | GRM1552C1H330JZ01D | K22178224 | | 66- | A | A1 | |
| C 2010 | CHIP CAP. | 27pF | 50V | CH | UMK105CH270JV-F | K22178268 | | 1- | A | A2 | |
| C 2010 | CHIP CAP. | 33pF | 50V | CH | GRM1552C1H330JZ01D | K22178224 | | 66- | A | A2 | |
| C 2011 | CHIP CAP. | 47pF | 50V | CH | UMK105CH470JV-F | K22178274 | | 1- | A | A2 | |
| C 2011 | CHIP CAP. | 27pF | 50V | CH | UMK105CH270JV-F | K22178268 | | 8- | A | A2 | |
| C 2011 | CHIP CAP. | 47pF | 50V | CH | GRM1552C1H470JZ01D | K22178228 | | 66- | A | A2 | |
| C 2012 | CHIP CAP. | 100pF | 50V | CH | UMK105CH101JV-F | K22178282 | | 1- | A | A1 | |
| C 2012 | CHIP CAP. | 47pF | 50V | CH | GRM1552C1H470JZ01D | K22178228 | | 66- | A | A1 | |
| C 2016 | CHIP CAP. | 12pF | 50V | CH | UMK105CH120JV-F | K22178260 | | 1- | A | A2 | |
| C 2016 | CHIP CAP. | 7pF | 50V | CH | UMK105CH070DV-F | K22178255 | | 8- | A | A2 | |
| C 2017 | CHIP CAP. | 12pF | 50V | CH | UMK105CH120JV-F | K22178260 | | 1- | A | A2 | |
| C 2017 | CHIP CAP. | 7pF | 50V | CH | UMK105CH070DV-F | K22178255 | | 8- | A | A2 | |
| C 2017 | CHIP CAP. | 33pF | 50V | CH | GRM1552C1H330JZ01D | K22178224 | | 66- | A | A2 | |
| C 2018 | CHIP CAP. | 10pF | 50V | CH | UMK105CH100DV-F | K22178258 | | 1- | A | A2 | |
| C 2018 | CHIP CAP. | 8pF | 50V | CH | GRM1552C1H8R0DZ01D | K22178210 | | 66- | A | A2 | |
| C 2019 | CHIP CAP. | 10pF | 50V | CH | UMK105CH100DV-F | K22178258 | | 1- | A | A1 | |
| C 2019 | CHIP CAP. | 22pF | 50V | CH | UMK105CH220JV-F | K22178266 | | 66- | A | A1 | |
| C 2020 | CHIP CAP. | 5pF | 50V | CH | UMK105CH050CV-F | K22178253 | | 1- | A | A1 | |
| C 2020 | CHIP CAP. | 9pF | 50V | CH | GRM1552C1H9R0DZ01D | K22178211 | | 66- | A | A1 | |
| C 2021 | CHIP CAP. | 5pF | 50V | CH | UMK105CH050CV-F | K22178253 | | 1- | A | A1 | |
| C 2021 | CHIP CAP. | 27pF | 50V | CH | GRM1552C1H270JZ01D | K22178222 | | 66- | A | A1 | |
| C 2022 | CHIP CAP. | 0.01uF | 16V | B | GRM36B103K16PT | K22128804 | | 1- | A | A2 | |
| C 2023 | CHIP CAP. | 0.01uF | 16V | B | GRM36B103K16PT | K22128804 | | 1- | A | A1 | |
| C 2024 | CHIP CAP. | 0.01uF | 16V | B | GRM36B103K16PT | K22128804 | | 1- | A | A1 | |
| C 2025 | CHIP TA.CAP. | 10uF | 10V | | TEMSVA1A106M-8R | K78100028 | | 1- | A | A1 | |
| C 2026 | CHIP CAP. | 4pF | 50V | CH | UMK105CH040CV-F | K22178252 | | 1- | A | A2 | |
| C 2026 | CHIP CAP. | 1pF | 50V | CK | UMK105CK010CV-F | K22178248 | | 12- | A | A2 | |
| C 2026 | CHIP CAP. | 3pF | 50V | CJ | UMK105CJ030CV-F | K22178251 | | 66- | A | A2 | |
| C 2027 | CHIP CAP. | 3pF | 50V | CJ | UMK105CJ030CV-F | K22178251 | | 1- | A | A2 | |
| C 2027 | CHIP CAP. | 1pF | 50V | CK | UMK105CK010CV-F | K22178248 | | 12- | A | A2 | |
| C 2027 | CHIP CAP. | 1.5pF | 50V | CK | GRM1554C1H1R5CZ01D | K22178203 | | 66- | A | A2 | |
| C 2028 | CHIP CAP. | 2pF | 50V | CK | UMK105CK020CV-F | K22178250 | | 1- | A | A1 | |
| C 2028 | CHIP CAP. | 1pF | 50V | CK | UMK105CK010CV-F | K22178248 | | 12- | A | A1 | |
| C 2028 | CHIP CAP. | 2pF | 50V | CK | GRM1554C1H2R0CZ01D | K22178204 | | 66- | A | A1 | |
| C 2029 | CHIP CAP. | 0.001uF | 50V | B | UMK105B102KW-F | K22178829 | | 1- | A | A1 | |
| C 2029 | CHIP CAP. | 0.001uF | 50V | B | GRM155B11H102KA01D | K22178809 | | 66- | A | A1 | |
| C 2030 | CHIP CAP. | 10pF | 50V | CH | UMK105CH100DV-F | K22178258 | | 12-65 | A | A2 | |
| C 2031 | CHIP CAP. | 0.001uF | 50V | B | UMK105B102KW-F | K22178829 | | 1- | A | A1 | |
| C 2031 | CHIP CAP. | 0.001uF | 50V | B | GRM155B11H102KA01D | K22178809 | | 66- | A | A1 | |
| C 2032 | CHIP CAP. | 15pF | 50V | CH | GRM1552C1H150JZ01D | K22178216 | | 66- | A | B1 | |
| C 2033 | CHIP TA.CAP. | 10uF | 10V | | TEMSVA1A106M-8R | K78100028 | | 1- | A | B2 | |
| C 2034 | CHIP TA.CAP. | 10uF | 10V | | TEMSVA1A106M-8R | K78100028 | | 1- | A | A1 | |
| C 2036 | CHIP CAP. | 0.01uF | 16V | B | GRM36B103K16PT | K22128804 | | 1- | A | B2 | |
| C 2037 | CHIP CAP. | 0.001uF | 50V | B | UMK105B102KW-F | K22178829 | | 1- | A | A1 | |
| C 2037 | CHIP CAP. | 0.001uF | 50V | B | GRM155B11H102KA01D | K22178809 | | 66- | A | A1 | |
| C 2038 | CHIP CAP. | 0.01uF | 50V | B | GRM188B11H103KA01D | K22174823 | | 1- | A | B1 | |
| C 2039 | CHIP CAP. | 0.01uF | 50V | B | GRM188B11H103KA01D | K22174823 | | 1- | A | B1 | |
| C 2041 | CHIP CAP. | 2pF | 50V | CK | UMK105CK020CV-F | K22178250 | | 1- | A | B1 | |
| C 2041 | CHIP CAP. | 1pF | 50V | CK | UMK105CK010CV-F | K22178248 | | 12- | A | B1 | |

PLL Unit

Parts List

| REF | DESCRIPTION | VALUE | V/W | TOL. | MFR'S DESIG | VXSTD P/N | VERS. | LOT | SIDE | LAY ADR |
|--------|--------------|---------|-----|------|--------------------|-----------|-------|-----|------|---------|
| C 2041 | CHIP CAP. | 3pF | 50V | CJ | UMK105CJ030CV-F | K22178251 | | 66- | A | B1 |
| C 2042 | CHIP CAP. | 3pF | 50V | CJ | UMK105CJ030CV-F | K22178251 | | 1- | A | B1 |
| C 2042 | CHIP CAP. | 1pF | 50V | CK | UMK105CK010CV-F | K22178248 | | 12- | A | B1 |
| C 2043 | CHIP CAP. | 0.01uF | 16V | B | GRM36B103K16PT | K22128804 | | 1- | A | B1 |
| C 2044 | CHIP CAP. | 33pF | 50V | CH | UMK105CH330JV-F | K22178270 | | 1- | A | B1 |
| C 2044 | CHIP CAP. | 27pF | 50V | CH | GRM1552C1H270JZ01D | K22178222 | | 66- | A | B1 |
| C 2045 | CHIP CAP. | 33pF | 50V | CH | UMK105CH330JV-F | K22178270 | | 1- | A | B2 |
| C 2045 | CHIP CAP. | 27pF | 50V | CH | GRM1552C1H270JZ01D | K22178222 | | 66- | A | B2 |
| C 2046 | CHIP CAP. | 7pF | 50V | CH | UMK105CH070DV-F | K22178255 | | 1- | A | B2 |
| C 2047 | CHIP CAP. | 7pF | 50V | CH | UMK105CH070DV-F | K22178255 | | 1- | A | B2 |
| C 2050 | CHIP CAP. | 0.001uF | 50V | B | UMK105B102KW-F | K22178829 | | 1- | A | B1 |
| C 2050 | CHIP CAP. | 0.001uF | 50V | B | GRM155B11H102KA01D | K22178809 | | 66- | A | B1 |
| C 2051 | CHIP CAP. | 0.001uF | 50V | B | UMK105B102KW-F | K22178829 | | 1- | A | B1 |
| C 2051 | CHIP CAP. | 0.001uF | 50V | B | GRM155B11H102KA01D | K22178809 | | 66- | A | B1 |
| C 2052 | CHIP CAP. | 0.001uF | 50V | B | UMK105B102KW-F | K22178829 | | 1- | A | A1 |
| C 2052 | CHIP CAP. | 0.001uF | 50V | B | GRM155B11H102KA01D | K22178809 | | 66- | A | A1 |
| C 2053 | CHIP CAP. | 5pF | 50V | CH | UMK105CH050CV-F | K22178253 | | 1- | A | B2 |
| C 2053 | CHIP CAP. | 8pF | 50V | CH | GRM1552C1H8R0DZ01D | K22178210 | | 66- | A | B2 |
| C 2054 | CHIP CAP. | 4pF | 50V | CH | UMK105CH040CV-F | K22178252 | | 1- | A | B2 |
| C 2056 | CHIP CAP. | 0.5pF | 50V | CK | UMK105CK0R5CV-F | K22178247 | | 64- | A | B2 |
| C 2056 | CHIP CAP. | 1pF | 50V | CK | UMK105CK010CV-F | K22178248 | | 66- | A | B2 |
| C 2057 | CHIP CAP. | 0.001uF | 50V | B | UMK105B102KW-F | K22178829 | | 1- | A | A1 |
| C 2057 | CHIP CAP. | 0.001uF | 50V | B | GRM155B11H102KA01D | K22178809 | | 66- | A | A1 |
| C 2058 | CHIP CAP. | 10pF | 50V | CH | UMK105CH100DV-F | K22178258 | | 1- | A | B2 |
| C 2059 | CHIP CAP. | 0.01uF | 16V | B | GRM36B103K16PT | K22128804 | | 1- | A | A1 |
| C 2060 | CHIP CAP. | 0.01uF | 16V | B | GRM36B103K16PT | K22128804 | | 1- | A | B1 |
| C 2061 | CHIP CAP. | 0.001uF | 50V | B | UMK105B102KW-F | K22178829 | | 1- | A | B2 |
| C 2061 | CHIP CAP. | 0.001uF | 50V | B | GRM155B11H102KA01D | K22178809 | | 66- | A | B2 |
| C 2062 | CHIP CAP. | 0.001uF | 50V | B | UMK105B102KW-F | K22178829 | | 1- | A | B2 |
| C 2062 | CHIP CAP. | 0.001uF | 50V | B | GRM155B11H102KA01D | K22178809 | | 66- | A | B2 |
| C 2063 | CHIP CAP. | 0.001uF | 50V | B | UMK105B102KW-F | K22178829 | | 1- | B | a1 |
| C 2063 | CHIP CAP. | 0.001uF | 50V | B | GRM155B11H102KA01D | K22178809 | | 66- | B | a1 |
| C 2064 | CHIP CAP. | 0.001uF | 50V | B | UMK105B102KW-F | K22178829 | | 1- | B | a1 |
| C 2064 | CHIP CAP. | 0.001uF | 50V | B | GRM155B11H102KA01D | K22178809 | | 66- | B | a1 |
| C 2065 | CHIP CAP. | 0.1uF | 10V | B | GRM155B11A104KA01D | K22108802 | | 1- | B | a1 |
| C 2066 | CHIP CAP. | 0.001uF | 50V | B | UMK105B102KW-F | K22178829 | | 1- | A | B1 |
| C 2066 | CHIP CAP. | 0.001uF | 50V | B | GRM155B11H102KA01D | K22178809 | | 66- | A | B1 |
| C 2067 | CHIP CAP. | 270pF | 50V | B | UMK105B271KW-F | K22178822 | | 1 | B | a1 |
| C 2067 | CHIP CAP. | 330pF | 50V | B | UMK105B331KW-F | K22178823 | | 2- | B | a1 |
| C 2067 | CHIP CAP. | 390pF | 50V | B | UMK105B391KW-F | K22178824 | | 66- | B | a1 |
| C 2068 | CHIP CAP. | 0.001uF | 50V | B | UMK105B102KW-F | K22178829 | | 1- | A | A1 |
| C 2068 | CHIP CAP. | 0.001uF | 50V | B | GRM155B11H102KA01D | K22178809 | | 66- | A | A1 |
| C 2069 | CHIP CAP. | 27pF | 50V | CH | UMK105CH270JV-F | K22178268 | | 1- | A | B1 |
| C 2069 | CHIP CAP. | 27pF | 50V | CH | GRM1552C1H270JZ01D | K22178222 | | 66- | A | B1 |
| C 2070 | CHIP CAP. | 22pF | 50V | CH | GRM1882C1H220JA01D | K22174219 | | 1 | B | a1 |
| C 2070 | CHIP CAP. | 82pF | 50V | CH | GRM1882C1H820JA01D | K22174233 | | 2- | B | a1 |
| C 2070 | CHIP CAP. | 39pF | 50V | CH | GRM1882C1H390JA01D | K22174225 | | 66- | B | a1 |
| C 2071 | CHIP CAP. | 390pF | 50V | B | UMK105B391KW-F | K22178824 | | 1 | B | a1 |
| C 2071 | CHIP CAP. | 680pF | 50V | B | UMK105B681KW-F | K22178827 | | 2- | B | a1 |
| C 2072 | CHIP CAP. | 47pF | 50V | CH | GRM1882C1H470JA01D | K22174227 | | 1 | B | a1 |
| C 2072 | CHIP CAP. | 68pF | 50V | CH | GRM1882C1H680JA01D | K22174231 | | 2- | B | a1 |
| C 2072 | CHIP CAP. | 33pF | 50V | CH | GRM1882C1H330JA01D | K22174223 | | 12- | B | a1 |
| C 2072 | CHIP CAP. | 120pF | 50V | CH | GRM1882C1H121JA01D | K22174237 | | 66- | B | a1 |
| C 2073 | CHIP CAP. | 0.001uF | 50V | B | UMK105B102KW-F | K22178829 | | 1- | A | A1 |
| C 2073 | CHIP CAP. | 0.001uF | 50V | B | GRM155B11H102KA01D | K22178809 | | 66- | A | A1 |
| C 2074 | CHIP CAP. | 0.001uF | 50V | B | UMK105B102KW-F | K22178829 | | 1- | B | a1 |
| C 2074 | CHIP CAP. | 0.001uF | 50V | B | GRM155B11H102KA01D | K22178809 | | 66- | B | a1 |
| C 2075 | CHIP CAP. | 390pF | 50V | B | UMK105B391KW-F | K22178824 | | 1 | B | a1 |
| C 2075 | CHIP CAP. | 680pF | 50V | B | UMK105B681KW-F | K22178827 | | 2- | B | a1 |
| C 2075 | CHIP CAP. | 560pF | 50V | B | UMK105B561KW-F | K22178826 | | 66- | B | a1 |
| C 2076 | CHIP CAP. | 0.001uF | 50V | B | UMK105B102KW-F | K22178829 | | 1- | A | B1 |
| C 2076 | CHIP CAP. | 0.001uF | 50V | B | GRM155B11H102KA01D | K22178809 | | 66- | A | B1 |
| C 2077 | CHIP CAP. | 68pF | 50V | CH | UMK105CH680JV-F | K22178278 | | 1 | B | a1 |
| C 2077 | CHIP CAP. | 22pF | 50V | CH | UMK105CH220JV-F | K22178266 | | 2- | B | a1 |
| C 2077 | CHIP CAP. | 27pF | 50V | CH | UMK105CH270JV-F | K22178268 | | 12- | B | a1 |
| C 2077 | CHIP CAP. | 220pF | 50V | CH | GRM1882C1H221JA01D | K22174243 | | 66- | B | a1 |
| C 2078 | CHIP TA.CAP. | 4.7uF | 16V | | TEMSVA1C475M-8R | K78120031 | | 1- | B | b1 |
| C 2079 | CHIP CAP. | 0.01uF | 16V | B | GRM36B103K16PT | K22128804 | | 1- | B | b1 |
| C 2080 | CHIP CAP. | 0.01uF | 16V | B | GRM36B103K16PT | K22128804 | | 1- | B | b2 |
| C 2081 | CHIP CAP. | 390pF | 50V | B | UMK105B391KW-F | K22178824 | | 1- | B | a1 |
| C 2081 | CHIP CAP. | 270pF | 50V | B | UMK105B271KW-F | K22178822 | | 66- | B | a1 |
| C 2082 | CHIP TA.CAP. | 10uF | 10V | | TEMSVA1A106M-8R | K78100028 | | 1- | B | b2 |
| C 2083 | CHIP CAP. | 0.01uF | 16V | B | GRM36B103K16PT | K22128804 | | 66- | B | a1 |

PLL Unit

Parts List

| REF | DESCRIPTION | VALUE | V/W | TOL. | MFR'S DESIG | VXSTD P/N | VERS. | LOT | SIDE | LAY ADR |
|--------|--------------|----------|-----|------|--------------------|-----------|-------|-------|------|---------|
| C 2084 | CHIP CAP. | 0.001uF | 50V | B | UMK105B102KW-F | K22178829 | | 1- | B | a1 |
| C 2084 | CHIP CAP. | 0.001uF | 50V | B | GRM155B11H102KA01D | K22178809 | | 66- | B | a1 |
| C 2085 | CHIP CAP. | 0.1uF | 16V | B | GRM188B11C104KA01D | K22124805 | | 1- | B | a1 |
| C 2085 | CHIP TA.CAP. | 4.7uF | 16V | | TEMSVA1C475M-8R | K78120031 | | 66- | B | a1 |
| C 2086 | CHIP TA.CAP. | 4.7uF | 16V | | TEMSVA1C475M-8R | K78120031 | | 1- | B | b1 |
| C 2087 | CHIP CAP. | 0.01uF | 16V | B | GRM36B103K16PT | K22128804 | | 1- | B | b1 |
| C 2088 | CHIP CAP. | 0.01uF | 16V | B | GRM36B103K16PT | K22128804 | | 1 | B | b1 |
| C 2088 | CHIP CAP. | 0.1uF | 10V | B | GRM155B11A104KA01D | K22108802 | | 2- | B | b1 |
| C 2090 | CHIP CAP. | 22pF | 50V | CH | GRM1882C1H220JA01D | K22174219 | | 1 | B | a1 |
| C 2090 | CHIP CAP. | 5pF | 50V | CH | GRM1882C1H5R0CZ01D | K22174206 | | 2- | B | a1 |
| C 2090 | CHIP CAP. | 47pF | 50V | CH | GRM1882C1H470JA01D | K22174227 | | 12- | B | a1 |
| C 2090 | CHIP CAP. | 47pF | 50V | CH | GRM1552C1H470JZ01D | K22178228 | | 66- | B | a1 |
| C 2091 | CHIP CAP. | 0.01uF | 50V | B | GRM188B11H103KA01D | K22174823 | | 1- | B | a2 |
| C 2092 | CHIP CAP. | 0.001uF | 50V | B | UMK105B102KW-F | K22178829 | | 1- | B | a1 |
| C 2092 | CHIP CAP. | 100pF | 50V | CH | GRM1552C1H101JD01D | K22178236 | | 66- | B | a1 |
| C 2093 | CHIP CAP. | 0.001uF | 50V | B | UMK105B102KW-F | K22178829 | | 1- | B | b1 |
| C 2093 | CHIP CAP. | 0.001uF | 50V | B | GRM155B11H102KA01D | K22178809 | | 66- | B | b1 |
| C 2094 | CHIP CAP. | 0.01uF | 50V | B | GRM188B11H103KA01D | K22174823 | | 1- | B | a2 |
| C 2095 | CHIP CAP. | 120pF | 50V | CH | UMK105CH121JV-F | K22178284 | | 1- | B | b1 |
| C 2096 | CHIP TA.CAP. | 1uF | 16V | | TMCSA1C105MTR | K78120023 | | 1- | B | a1 |
| C 2097 | CHIP CAP. | 180pF | 25V | CH | GRM36CH181J25PT | K22148201 | | 1- | B | b1 |
| C 2097 | CHIP CAP. | 180pF | 25V | CH | TMK105CH181JV-F | K22148244 | | 66- | B | b1 |
| C 2099 | CHIP CAP. | 0.1uF | 16V | B | GRM188B11C104KA01D | K22124805 | | 1- | B | a2 |
| C 2099 | CHIP CAP. | 0.01uF | 16V | B | GRM36B103K16PT | K22128804 | | 66- | B | a2 |
| C 2100 | CHIP CAP. | 120pF | 50V | CH | UMK105CH121JV-F | K22178284 | | 1- | B | b1 |
| C 2101 | CHIP CAP. | 0.01uF | 50V | B | GRM188B11H103KA01D | K22174823 | | 1- | B | a2 |
| C 2101 | CHIP CAP. | 0.01uF | 16V | B | GRM36B103K16PT | K22128804 | | 66- | B | a2 |
| C 2102 | CHIP TA.CAP. | 10uF | 10V | | TEMSVA1A106M-8R | K78100028 | | 1- | B | a2 |
| C 2103 | CHIP CAP. | 0.01uF | 16V | B | GRM36B103K16PT | K22128804 | | 1- | A | B1 |
| C 2104 | CHIP CAP. | 22pF | 50V | CH | UMK105CH220JV-F | K22178266 | | 1- | B | b1 |
| C 2105 | CHIP CAP. | 0.001uF | 50V | B | UMK105B102KW-F | K22178829 | | 1- | A | B1 |
| C 2105 | CHIP CAP. | 0.001uF | 50V | B | GRM155B11H102KA01D | K22178809 | | 66- | A | B1 |
| C 2106 | CHIP CAP. | 0.01uF | 16V | B | GRM36B103K16PT | K22128804 | | 1- | A | B1 |
| C 2107 | CHIP CAP. | 0.01uF | 16V | B | GRM36B103K16PT | K22128804 | | 1- | B | a1 |
| C 2108 | CHIP CAP. | 15pF | 50V | CH | UMK105CH150JV-F | K22178262 | | 1- | A | B1 |
| C 2109 | CHIP CAP. | 47pF | 50V | CH | UMK105CH470JV-F | K22178274 | | 1- | A | B1 |
| C 2109 | CHIP CAP. | 47pF | 50V | CH | GRM1552C1H470JZ01D | K22178228 | | 66- | A | B1 |
| C 2110 | CHIP CAP. | 27pF | 50V | CH | UMK105CH270JV-F | K22178268 | | 1- | A | B1 |
| C 2110 | CHIP CAP. | 27pF | 50V | CH | GRM1552C1H270JZ01D | K22178222 | | 66- | A | B1 |
| C 2111 | CHIP CAP. | 27pF | 50V | CH | UMK105CH270JV-F | K22178268 | | 1- | A | B1 |
| C 2111 | CHIP CAP. | 27pF | 50V | CH | GRM1552C1H270JZ01D | K22178222 | | 66- | A | B1 |
| C 2112 | CHIP CAP. | 15pF | 50V | CH | UMK105CH150JV-F | K22178262 | | 1- | A | B1 |
| C 2113 | CHIP CAP. | 0.001uF | 50V | B | UMK105B102KW-F | K22178829 | | 1- | A | B1 |
| C 2113 | CHIP CAP. | 0.001uF | 50V | B | GRM155B11H102KA01D | K22178809 | | 66- | A | B1 |
| C 2114 | CHIP CAP. | 4pF | 50V | CH | UMK105CH040CV-F | K22178252 | | 1- | A | B1 |
| C 2115 | CHIP CAP. | 12pF | 50V | CH | UMK105CH120JV-F | K22178260 | | 1- | A | B1 |
| C 2116 | CHIP CAP. | 4pF | 50V | CH | UMK105CH040CV-F | K22178252 | | 1- | A | B1 |
| C 2128 | CHIP CAP. | 0.001uF | 50V | B | UMK105B102KW-F | K22178829 | | 1- | A | B1 |
| C 2128 | CHIP CAP. | 0.001uF | 50V | B | GRM155B11H102KA01D | K22178809 | | 66- | A | B1 |
| C 2129 | CHIP CAP. | 3pF | 50V | CJ | UMK105CJ030CV-F | K22178251 | | 1- | A | A1 |
| C 2129 | CHIP CAP. | 2pF | 50V | CK | UMK105CK020CV-F | K22178250 | | 8- | A | A1 |
| C 2129 | CHIP CAP. | 1pF | 50V | CK | UMK105CK010CV-F | K22178248 | | 66- | A | A1 |
| C 2130 | CHIP CAP. | 1pF | 50V | CK | UMK105CK010CV-F | K22178248 | | 66- | A | A2 |
| C 2131 | CHIP CAP. | 0.5pF | 50V | CK | UMK105CK0R5CV-F | K22178247 | | 66- | A | A2 |
| C 2132 | CHIP CAP. | 100pF | 50V | CH | UMK105CH101JV-F | K22178282 | | 1 | B | b2 |
| C 2133 | CHIP CAP. | 0.01uF | 16V | B | GRM36B103K16PT | K22128804 | | 1- | B | b1 |
| C 2134 | CHIP CAP. | 0.01uF | 16V | B | GRM36B103K16PT | K22128804 | | 1- | B | b1 |
| C 2136 | CHIP CAP. | 100pF | 50V | CH | GRM1552C1H101JD01D | K22178236 | | 66- | B | a2 |
| C 2137 | CHIP CAP. | 820pF | 50V | B | UMK105B821KW-F | K22178828 | | 12- | B | a1 |
| C 2137 | CHIP CAP. | 470pF | 50V | B | GRM155B11H471KA01D | K22178805 | | 66- | B | a1 |
| C 2138 | CHIP CAP. | 820pF | 50V | B | UMK105B821KW-F | K22178828 | | 12- | B | a1 |
| C 2138 | CHIP CAP. | 470pF | 50V | B | GRM155B11H471KA01D | K22178805 | | 66- | B | a1 |
| C 2139 | CHIP CAP. | 0.0012uF | 50V | B | UMK105B122KW-F | K22178830 | | 12-65 | | |
| C 2140 | CHIP CAP. | 0.01uF | 16V | B | GRM36B103K16PT | K22128804 | | 66- | B | a2 |
| C 2141 | CHIP TA.CAP. | 4.7uF | 16V | | TEMSVA1C475M-8R | K78120031 | | 66- | B | a2 |
| D 2001 | DIODE | | | | HVC362TRF-E | G2070636 | | 1- | A | A2 |
| D 2001 | DIODE | | | | 1SV282(TPH3.F) | G2070778 | | 8- | A | A2 |
| D 2001 | DIODE | | | | 1SV325(TPH3.F) | G2070848 | | 66- | A | A2 |
| D 2002 | DIODE | | | | HVC362TRF-E | G2070636 | | 1- | A | A2 |
| D 2002 | DIODE | | | | 1SV282(TPH3.F) | G2070778 | | 8- | A | A2 |
| D 2002 | DIODE | | | | 1SV325(TPH3.F) | G2070848 | | 66- | A | A2 |
| D 2003 | DIODE | | | | HVC362TRF-E | G2070636 | | 1- | A | A1 |
| D 2003 | DIODE | | | | 1SV282(TPH3.F) | G2070778 | | 8- | A | A1 |

PLL Unit

Parts List

| REF | DESCRIPTION | VALUE | V/W | TOL. | MFR'S DESIG | VXSTD P/N | VERS. | LOT | SIDE | LAY ADR |
|--------|-------------|---------|-----|------|--------------------|-----------|-------|-----|------|---------|
| D 2003 | DIODE | | | | 1SV325(TPH3.F) | G2070848 | | 66- | A | A1 |
| D 2004 | DIODE | | | | HVC362TRF-E | G2070636 | | 1- | A | A2 |
| D 2004 | DIODE | | | | 1SV325(TPH3.F) | G2070848 | | 66- | A | A2 |
| D 2005 | DIODE | | | | HVC362TRF-E | G2070636 | | 1- | A | A2 |
| D 2005 | DIODE | | | | 1SV325(TPH3.F) | G2070848 | | 66- | A | A2 |
| D 2006 | DIODE | | | | HVC362TRF-E | G2070636 | | 1- | A | A1 |
| D 2006 | DIODE | | | | 1SV325(TPH3.F) | G2070848 | | 66- | A | A1 |
| D 2007 | DIODE | | | | 1SV282(TPH3.F) | G2070778 | | 1- | A | B2 |
| D 2008 | DIODE | | | | 1SV281(TPH3.F) | G2070620 | | 1- | A | B2 |
| D 2009 | DIODE | | | | 1SV286(TPH3.F) | G2070610 | | 1- | A | B2 |
| D 2009 | DIODE | | | | 1SV284(TPH3.F) | G2070622 | | 66- | A | B2 |
| D 2010 | DIODE | | | | DAP236U T106 | G2070592 | | 1- | A | B1 |
| D 2011 | DIODE | | | | HSC277TRF-E | G2070584 | | 1- | A | B1 |
| D 2012 | DIODE | | | | DAP222-TL | G2070432 | | 1- | A | B2 |
| D 2013 | DIODE | | | | DAP236U T106 | G2070592 | | 1- | A | B1 |
| D 2014 | DIODE | | | | HSC277TRF-E | G2070584 | | 1- | A | B1 |
| D 2015 | DIODE | | | | HSC277TRF-E | G2070584 | | 1- | A | A1 |
| D 2016 | DIODE | | | | HSC277TRF-E | G2070584 | | 1- | A | B1 |
| D 2017 | DIODE | | | | DAP222-TL | G2070432 | | 1- | A | B2 |
| D 2018 | DIODE | | | | DAN222 TL | G2070174 | | 66- | B | b2 |
| J 2001 | CONNECTOR | | | | 9230B-1-12Z003-T | P0090896 | | 1- | B | b1 |
| J 2002 | CONNECTOR | | | | 9230B-1-12Z003-T | P0090896 | | 1- | B | a2 |
| L 2001 | M.RFC | 4.7uH | | | LK1608 4R7K-T | L1690688 | | 1- | A | A2 |
| L 2002 | M.RFC | 4.7uH | | | LK1608 4R7K-T | L1690688 | | 1- | A | A2 |
| L 2003 | M.RFC | 4.7uH | | | LK1608 4R7K-T | L1690688 | | 1- | A | A1 |
| L 2004 | M.RFC | 4.7uH | | | LK1608 4R7K-T | L1690688 | | 1- | A | A2 |
| L 2005 | M.RFC | 4.7uH | | | LK1608 4R7K-T | L1690688 | | 1- | A | A2 |
| L 2006 | M.RFC | 4.7uH | | | LK1608 4R7K-T | L1690688 | | 1- | A | A1 |
| L 2007 | M.RFC | 1uH | | | LK1608 1R0K-T | L1690687 | | 1- | A | B1 |
| L 2008 | M.RFC | 1uH | | | LK1608 1R0K-T | L1690687 | | 1- | A | B1 |
| L 2009 | M.RFC | 0.01uH | | | HK1608 10NJ-T | L1690516 | | 1- | A | B1 |
| L 2009 | M.RFC | 0.015uH | | | HK1608 15NJ-T | L1690518 | | 68- | A | B1 |
| L 2010 | COIL | | | | E2 0.4-2.0-5.5T-L | L0022630 | | 1- | A | B2 |
| L 2010 | COIL | 0.038uH | | | AS050630-38N | L0022818 | | 66- | A | B2 |
| L 2011 | COIL | | | | E2 0.45-1.4-2.5T-L | L0022618 | | 1- | A | B2 |
| L 2011 | COIL | 0.009uH | | | AS050325-9RONK | L0022612 | | 64- | A | B2 |
| L 2012 | M.RFC | 4.7uH | | | LK1608 4R7K-T | L1690688 | | 1- | A | B2 |
| L 2013 | M.RFC | 4.7uH | | | LK1608 4R7K-T | L1690688 | | 1- | A | B2 |
| L 2014 | M.RFC | 2.2uH | | | LK1608 2R2K-T | L1690634 | | 1 | B | a1 |
| L 2014 | M.RFC | 1.2uH | | | LK1608 1R2K-T | L1690845 | | 2- | B | a1 |
| L 2015 | M.RFC | 2.2uH | | | LK1608 2R2K-T | L1690634 | | 1 | B | a1 |
| L 2015 | M.RFC | 1.8uH | | | LK1608 1R8K-T | L1690847 | | 2- | B | a1 |
| L 2015 | M.RFC | 1uH | | | LK1608 1R0K-T | L1690687 | | 66- | B | a1 |
| L 2016 | M.RFC | 1.8uH | | | LK1608 1R8K-T | L1690847 | | 1- | B | a1 |
| L 2016 | M.RFC | 0.68uH | | | LK1608 R68K-T | L1690416 | | 66- | B | a1 |
| L 2017 | M.RFC | 0.082uH | | | HK1608 82NJ-T | L1690527 | | 1- | A | B1 |
| L 2018 | M.RFC | 10uH | | | LK1608 100K-T | L1690689 | | 1- | B | a1 |
| L 2019 | M.RFC | 10uH | | | LK1608 100K-T | L1690689 | | 1- | B | b1 |
| L 2020 | M.RFC | 0.47uH | | | LK1608 R47K-T | L1690414 | | 1- | B | b1 |
| L 2021 | M.RFC | 0.47uH | | | LK1608 R47K-T | L1690414 | | 1- | B | b1 |
| L 2022 | M.RFC | 0.047uH | | | HK1608 47NJ-T | L1690524 | | 1- | A | B1 |
| L 2023 | M.RFC | 1.8uH | | | LK1608 1R8K-T | L1690847 | | 1- | B | b1 |
| L 2024 | M.RFC | 0.082uH | | | HK1608 82NJ-T | L1690527 | | 1- | A | B1 |
| L 2025 | M.RFC | 0.047uH | | | HK1608 47NJ-T | L1690524 | | 1- | A | B1 |
| L 2026 | M.RFC | 0.018uH | | | HK1608 18NJ-T | L1690519 | | 1- | A | B1 |
| L 2027 | M.RFC | 0.018uH | | | HK1608 18NJ-T | L1690519 | | 1- | A | B1 |
| L 2028 | M.RFC | 0.33uH | | | LK1608 R33K-T | L1690412 | | 12- | A | A1 |
| L 2029 | M.RFC | 2.2uH | | | LK1608 2R2K-T | L1690634 | | 12- | B | a1 |
| L 2029 | M.RFC | 1uH | | | LK1608 1R0K-T | L1690687 | | 66- | B | a1 |
| L 2030 | M.RFC | 10uH | | | LK1608 100K-T | L1690689 | | 66- | B | a2 |
| L 2031 | M.RFC | 10uH | | | LK1608 100K-T | L1690689 | | 66- | B | a2 |
| Q 2001 | TRANSISTOR | | | | DTC124EU T106 | G3070045 | | 1- | A | B2 |
| Q 2002 | TRANSISTOR | | | | DTC124EU T106 | G3070045 | | 1- | A | A2 |
| Q 2003 | TRANSISTOR | | | | DTC124EU T106 | G3070045 | | 1- | A | A1 |
| Q 2004 | FET | | | | 2SK210-GR(TE85R.F) | G3802107G | | 1- | A | A2 |
| Q 2005 | FET | | | | 2SK210-GR(TE85R.F) | G3802107G | | 1- | A | A2 |
| Q 2006 | FET | | | | 2SK210-GR(TE85R.F) | G3802107G | | 1- | A | A1 |
| Q 2007 | TRANSISTOR | | | | 2SC4154-T11-1E | G3341548E | | 1- | A | A1 |
| Q 2009 | TRANSISTOR | | | | 2SC5374-TL | G3353748 | | 1- | A | B1 |
| Q 2010 | TRANSISTOR | | | | 2SC5374-TL | G3353748 | | 1- | A | B2 |
| Q 2011 | TRANSISTOR | | | | 2SC5374-TL | G3353748 | | 1- | A | B1 |
| Q 2012 | TRANSISTOR | | | | DTC124EU T106 | G3070045 | | 1- | A | B1 |
| Q 2013 | TRANSISTOR | | | | DTC124EU T106 | G3070045 | | 1- | A | B1 |

PLL Unit

Parts List

| REF | DESCRIPTION | VALUE | V/W | TOL. | MFR'S DESIG | VXSTD P/N | VERS. | LOT | SIDE | LAY ADR |
|--------|-------------|-------|-------|------|------------------|-----------|-------|-----|------|---------|
| Q 2016 | IC | | | | AD9850BR5Z-REEL | G1092567 | | 1- | B | b1 |
| Q 2018 | IC | | | | BU4094BCFV-E2 | G1093527 | | 1- | B | b2 |
| Q 2019 | TRANSISTOR | | | | 2SC4400-4-TL | G3344008D | | 66- | B | a1 |
| Q 2020 | TRANSISTOR | | | | 2SC4400-4-TL | G3344008D | | 1- | B | b1 |
| Q 2021 | IC | | | | FQ7925 | G1091710 | | 1- | B | a2 |
| Q 2021 | IC | | | | ADF4116BRU(TAPE) | G1093581 | | 66- | B | a2 |
| Q 2022 | IC | | | | UPC2713T-E3 | G1092862 | | 1- | A | A1 |
| Q 2022 | IC | | | | UPC2710TB-E3 | G1093932 | | 12- | A | A1 |
| Q 2023 | IC | | | | UPC1688G-T1-A | G1092286 | | 1- | B | a1 |
| Q 2023 | IC | | | | TA4002F(TE85L.F) | G1092813 | | 12- | B | a1 |
| Q 2024 | TRANSISTOR | | | | DTC124EU T106 | G3070045 | | 66- | B | b2 |
| Q 2025 | TRANSISTOR | | | | DTC124EU T106 | G3070045 | | 66- | B | b1 |
| Q 2026 | TRANSISTOR | | | | DTC124EU T106 | G3070045 | | 66- | B | b1 |
| Q 2027 | TRANSISTOR | | | | DTC124EU T106 | G3070045 | | 66- | B | a2 |
| R 2001 | CHIP RES. | 47 | 1/16W | 5% | RMC1/16S 470JTH | J24189009 | | 1- | A | A2 |
| R 2002 | CHIP RES. | 47 | 1/16W | 5% | RMC1/16S 470JTH | J24189009 | | 1- | A | A2 |
| R 2003 | CHIP RES. | 47 | 1/16W | 5% | RMC1/16S 470JTH | J24189009 | | 1- | A | A1 |
| R 2004 | CHIP RES. | 470k | 1/16W | 5% | RMC1/16S 474JTH | J24189057 | | 1- | A | A2 |
| R 2004 | CHIP RES. | 100k | 1/16W | 5% | RMC1/16S 104JTH | J24189049 | | 66- | A | A2 |
| R 2005 | CHIP RES. | 470k | 1/16W | 5% | RMC1/16S 474JTH | J24189057 | | 1- | A | A2 |
| R 2005 | CHIP RES. | 100k | 1/16W | 5% | RMC1/16S 104JTH | J24189049 | | 66- | A | A2 |
| R 2006 | CHIP RES. | 470k | 1/16W | 5% | RMC1/16S 474JTH | J24189057 | | 1- | A | A1 |
| R 2006 | CHIP RES. | 100k | 1/16W | 5% | RMC1/16S 104JTH | J24189049 | | 66- | A | A1 |
| R 2007 | CHIP RES. | 68 | 1/16W | 5% | RMC1/16S 680JTH | J24189011 | | 1- | A | A2 |
| R 2007 | CHIP RES. | 150 | 1/16W | 5% | RMC1/16S 151JTH | J24189015 | | 66- | A | A2 |
| R 2008 | CHIP RES. | 68 | 1/16W | 5% | RMC1/16S 680JTH | J24189011 | | 1- | A | A2 |
| R 2008 | CHIP RES. | 150 | 1/16W | 5% | RMC1/16S 151JTH | J24189015 | | 66- | A | A2 |
| R 2009 | CHIP RES. | 68 | 1/16W | 5% | RMC1/16S 680JTH | J24189011 | | 1- | A | A1 |
| R 2009 | CHIP RES. | 150 | 1/16W | 5% | RMC1/16S 151JTH | J24189015 | | 66- | A | A1 |
| R 2010 | CHIP RES. | 47 | 1/16W | 5% | RMC1/16S 470JTH | J24189009 | | 1- | A | A1 |
| R 2010 | CHIP RES. | 100 | 1/16W | 5% | RMC1/16S 101JTH | J24189013 | | 12- | A | A1 |
| R 2011 | CHIP RES. | 1k | 1/16W | 5% | RMC1/16S 102JTH | J24189025 | | 1- | A | A1 |
| R 2011 | CHIP RES. | 470 | 1/16W | 5% | RMC1/16S 471JTH | J24189021 | | 12- | A | A1 |
| R 2011 | CHIP RES. | 1k | 1/16W | 5% | RMC1/16S 102JTH | J24189025 | | 66- | A | A1 |
| R 2012 | CHIP RES. | 2.2k | 1/16W | 5% | RMC1/16S 222JTH | J24189029 | | 1- | B | a1 |
| R 2013 | CHIP RES. | 100 | 1/16W | 5% | RMC1/16S 101JTH | J24189013 | | 1- | A | B1 |
| R 2014 | CHIP RES. | 470 | 1/16W | 5% | RMC1/16S 471JTH | J24189021 | | 1- | A | B1 |
| R 2014 | CHIP RES. | 680 | 1/16W | 5% | RMC1/16S 681JTH | J24189023 | | 66- | A | B1 |
| R 2015 | CHIP RES. | 100 | 1/16W | 5% | RMC1/16S 101JTH | J24189013 | | 1- | A | B2 |
| R 2016 | CHIP RES. | 470 | 1/16W | 5% | RMC1/16S 471JTH | J24189021 | | 1- | A | B1 |
| R 2017 | CHIP RES. | 2.2k | 1/16W | 5% | RMC1/16S 222JTH | J24189029 | | 1- | A | A1 |
| R 2018 | CHIP RES. | 68k | 1/16W | 5% | RMC1/16S 683JTH | J24189047 | | 1- | A | B1 |
| R 2018 | CHIP RES. | 47k | 1/16W | 5% | RMC1/16S 473JTH | J24189045 | | 12- | A | B1 |
| R 2019 | CHIP RES. | 4.7k | 1/16W | 5% | RMC1/16S 472JTH | J24189033 | | 1- | A | B1 |
| R 2020 | CHIP RES. | 4.7k | 1/16W | 5% | RMC1/16S 472JTH | J24189033 | | 1- | A | B2 |
| R 2021 | CHIP RES. | 10k | 1/16W | 5% | RMC1/16S 103JTH | J24189037 | | 1- | A | B2 |
| R 2021 | CHIP RES. | 6.8k | 1/16W | 5% | RMC1/16S 682JTH | J24189035 | | 12- | A | B2 |
| R 2022 | CHIP RES. | 10k | 1/16W | 5% | RMC1/16S 103JTH | J24189037 | | 1- | A | B2 |
| R 2022 | CHIP RES. | 6.8k | 1/16W | 5% | RMC1/16S 682JTH | J24189035 | | 12- | A | B2 |
| R 2023 | CHIP RES. | 560 | 1/16W | 5% | RMC1/16S 561JTH | J24189022 | | 1- | A | B1 |
| R 2024 | CHIP RES. | 100 | 1/16W | 5% | RMC1/16S 101JTH | J24189013 | | 1- | A | B1 |
| R 2025 | CHIP RES. | 1.5k | 1/16W | 5% | RMC1/16S 152JTH | J24189027 | | 1- | A | B1 |
| R 2026 | CHIP RES. | 1.5k | 1/16W | 5% | RMC1/16S 152JTH | J24189027 | | 1- | A | B1 |
| R 2027 | CHIP RES. | 1.5k | 1/16W | 5% | RMC1/16S 152JTH | J24189027 | | 1- | A | B1 |
| R 2028 | CHIP RES. | 2.2k | 1/16W | 5% | RMC1/16S 222JTH | J24189029 | | 1- | B | b1 |
| R 2029 | CHIP RES. | 47 | 1/16W | 5% | RMC1/16S 470JTH | J24189009 | | 1- | A | B2 |
| R 2030 | CHIP RES. | 47 | 1/16W | 5% | RMC1/16S 470JTH | J24189009 | | 1- | A | B2 |
| R 2031 | CHIP RES. | 6.8k | 1/16W | 5% | RMC1/16S 682JTH | J24189035 | | 66- | A | A1 |
| R 2032 | CHIP RES. | 100 | 1/16W | 5% | RMC1/16S 101JTH | J24189013 | | 1 | B | b1 |
| R 2032 | CHIP RES. | 47 | 1/16W | 5% | RMC1/16S 470JTH | J24189009 | | 2- | B | b1 |
| R 2032 | CHIP RES. | 100 | 1/16W | 5% | RMC1/16S 101JTH | J24189013 | | 12- | B | b1 |
| R 2041 | CHIP RES. | 470 | 1/16W | 5% | RMC1/16S 471JTH | J24189021 | | 1- | B | b1 |
| R 2041 | CHIP RES. | 100 | 1/16W | 5% | RMC1/16S 101JTH | J24189013 | | 66- | B | b1 |
| R 2043 | CHIP RES. | 470 | 1/16W | 5% | RMC1/16S 471JTH | J24189021 | | 1- | B | b2 |
| R 2043 | CHIP RES. | 100 | 1/16W | 5% | RMC1/16S 101JTH | J24189013 | | 66- | B | b2 |
| R 2044 | CHIP RES. | 470 | 1/16W | 5% | RMC1/16S 471JTH | J24189021 | | 1- | B | b2 |
| R 2044 | CHIP RES. | 100 | 1/16W | 5% | RMC1/16S 101JTH | J24189013 | | 66- | B | b2 |
| R 2045 | CHIP RES. | 470 | 1/16W | 5% | RMC1/16S 471JTH | J24189021 | | 1- | B | b2 |
| R 2045 | CHIP RES. | 100 | 1/16W | 5% | RMC1/16S 101JTH | J24189013 | | 66- | B | b2 |
| R 2047 | CHIP RES. | 470 | 1/16W | 5% | RMC1/16S 471JTH | J24189021 | | 1- | B | b1 |
| R 2047 | CHIP RES. | 100 | 1/16W | 5% | RMC1/16S 101JTH | J24189013 | | 66- | B | b1 |
| R 2049 | CHIP RES. | 470 | 1/16W | 5% | RMC1/16S 471JTH | J24189021 | | 1- | B | b1 |
| R 2049 | CHIP RES. | 100 | 1/16W | 5% | RMC1/16S 101JTH | J24189013 | | 66- | B | b1 |

PLL Unit

Parts List

| REF | DESCRIPTION | VALUE | V/W | TOL. | MFR'S DESIG | VXSTD P/N | VERS. | LOT | SIDE | LAY ADR |
|--------|-------------------|-------|-------|------|--------------------|-----------|-------|-------|------|---------|
| R 2052 | CHIP RES. | 27 | 1/16W | 5% | RMC1/16S 270JTH | J24189006 | | 1- | B | b1 |
| R 2053 | CHIP RES. | 2.2k | 1/16W | 5% | RMC1/16S 222JTH | J24189029 | | 1- | B | b1 |
| R 2054 | CHIP RES. | 6.8k | 1/16W | 5% | RMC1/16S 682JTH | J24189035 | | 1- | B | b1 |
| R 2055 | CHIP RES. | 220k | 1/16W | 5% | RMC1/16S 224JTH | J24189053 | | 1- | B | b1 |
| R 2056 | CHIP RES. | 1k | 1/16W | 5% | RMC1/16S 102JTH | J24189025 | | 1- | A | B1 |
| R 2056 | CHIP RES. | 47 | 1/16W | 5% | RMC1/16S 470JTH | J24189009 | | 66- | A | B1 |
| R 2056 | CHIP RES. | 220 | 1/16W | 5% | RMC1/16S 221JTH | J24189017 | | 68- | A | B1 |
| R 2057 | CHIP RES. | 1k | 1/16W | 5% | RMC1/16S 102JTH | J24189025 | | 1- | B | a2 |
| R 2058 | CHIP RES. | 1M | 1/16W | 5% | RMC1/16S 105JTH | J24189061 | | 1-65 | B | a2 |
| R 2059 | CHIP RES. | 1k | 1/16W | 5% | RMC1/16S 102JTH | J24189025 | | 1- | B | a2 |
| R 2060 | CHIP RES. | 470 | 1/16W | 5% | RMC1/16S 471JTH | J24189021 | | 1- | B | a1 |
| R 2060 | CHIP RES. | 33k | 1/16W | 5% | RMC1/16S 333JTH | J24189043 | | 66- | B | a1 |
| R 2061 | CHIP RES. | 470 | 1/16W | 5% | RMC1/16S 471JTH | J24189021 | | 1- | B | a1 |
| R 2062 | CHIP RES. | 470 | 1/16W | 5% | RMC1/16S 471JTH | J24189021 | | 1 | B | a2 |
| R 2062 | CHIP RES. | 270 | 1/16W | 5% | RMC1/16S 271JTH | J24189018 | | 2- | B | a2 |
| R 2063 | CHIP RES. | 470 | 1/16W | 5% | RMC1/16S 471JTH | J24189021 | | 1-65 | B | a1 |
| R 2064 | CHIP RES. | 3.3k | 1/16W | 5% | RMC1/16S 332JTH | J24189031 | | 1- | B | a2 |
| R 2065 | CHIP RES. | 0 | 1/16W | 5% | RMC1/16S JPTH | J24189070 | | 1-65 | B | a2 |
| R 2067 | CHIP RES. | 10 | 1/16W | 5% | RMC1/16S 100JTH | J24189001 | | 1- | A | B1 |
| R 2067 | CHIP RES. | 100 | 1/16W | 5% | RMC1/16S 101JTH | J24189013 | | 12- | A | B1 |
| R 2067 | CHIP RES. | 10 | 1/16W | 5% | RMC1/16S 100JTH | J24189001 | | 68- | A | B1 |
| R 2068 | CHIP RES. | 1k | 1/16W | 5% | RMC1/16S 102JTH | J24189025 | | 1- | B | b1 |
| R 2069 | CHIP RES. | 1k | 1/16W | 5% | RMC1/16S 102JTH | J24189025 | | 1- | B | b1 |
| R 2070 | CHIP RES. | 2.2k | 1/16W | 5% | RMC1/16S 222JTH | J24189029 | | 1- | A | B1 |
| R 2071 | CHIP RES. | 470 | 1/16W | 5% | RMC1/16S 471JTH | J24189021 | | 1- | B | a1 |
| R 2071 | CHIP RES. | 47 | 1/16W | 5% | RMC1/16S 470JTH | J24189009 | | 12- | B | a1 |
| R 2073 | CHIP RES. | 47 | 1/16W | 5% | RMC1/16S 470JTH | J24189009 | | 1- | B | a2 |
| R 2074 | CHIP RES. | 3.3k | 1/16W | 5% | RMC1/16S 332JTH | J24189031 | | 1- | A | B1 |
| R 2075 | CHIP RES. | 47k | 1/16W | 5% | RMC1/16S 473JTH | J24189045 | | 1- | A | B1 |
| R 2076 | CHIP RES. | 47k | 1/16W | 5% | RMC1/16S 473JTH | J24189045 | | 1- | A | B1 |
| R 2077 | CHIP RES. | 47k | 1/16W | 5% | RMC1/16S 473JTH | J24189045 | | 1- | A | B1 |
| R 2078 | CHIP RES. | 47 | 1/16W | 5% | RMC1/16S 470JTH | J24189009 | | 1- | A | A1 |
| R 2079 | CHIP RES. | 10 | 1/16W | 5% | RMC1/16S 100JTH | J24189001 | | 1- | B | a1 |
| R 2080 | CHIP RES. | 3.3k | 1/16W | 5% | RMC1/16S 332JTH | J24189031 | | 1- | A | B1 |
| R 2081 | CHIP RES. | 10 | 1/16W | 5% | RMC1/16S 100JTH | J24189001 | | 1- | B | a2 |
| R 2081 | CHIP RES. | 100 | 1/16W | 5% | RMC1/16S 101JTH | J24189013 | | 66- | B | a2 |
| R 2082 | CHIP RES. | 100 | 1/16W | 5% | RMC1/16S 101JTH | J24189013 | | 1- | A | B1 |
| R 2083 | CHIP RES. | 100 | 1/16W | 5% | RMC1/16S 101JTH | J24189013 | | 1- | A | B2 |
| R 2083 | CHIP RES. | 100k | 1/16W | 5% | RMC1/16S 104JTH | J24189049 | | 66- | A | B2 |
| R 2084 | CHIP RES. | 100 | 1/16W | 5% | RMC1/16S 101JTH | J24189013 | | 1- | B | a2 |
| R 2085 | CHIP RES. | 100 | 1/16W | 5% | RMC1/16S 101JTH | J24189013 | | 1- | B | a2 |
| R 2086 | CHIP RES. | 100 | 1/16W | 5% | RMC1/16S 101JTH | J24189013 | | 1- | B | a2 |
| R 2087 | CHIP RES. | 100 | 1/16W | 5% | RMC1/16S 101JTH | J24189013 | | 1-65 | | |
| R 2088 | CHIP RES. | 47 | 1/16W | 5% | RMC1/16S 470JTH | J24189009 | | 12-65 | | |
| R 2089 | CHIP RES. | 100 | 1/16W | 5% | RMC1/16S 101JTH | J24189013 | | 12-65 | | |
| T 2001 | COIL 05RF | | | | CS-4N 5203-JPS-076 | L0022507 | | 1- | A | A2 |
| T 2002 | COIL 05RF | | | | CS-4N 5203-JPS-077 | L0022508 | | 1- | A | A1 |
| T 2003 | COIL 05RF | | | | CS-4N 5203-JPS-078 | L0022509 | | 1- | A | A1 |
| | SHIELD CASE PLL | | | | | RA0271100 | | 1- | | |
| | SHIELD CASE COVER | | | | | RA02712A0 | | 1- | | |

PA Unit (Lot 1 ~ 59)

Note:

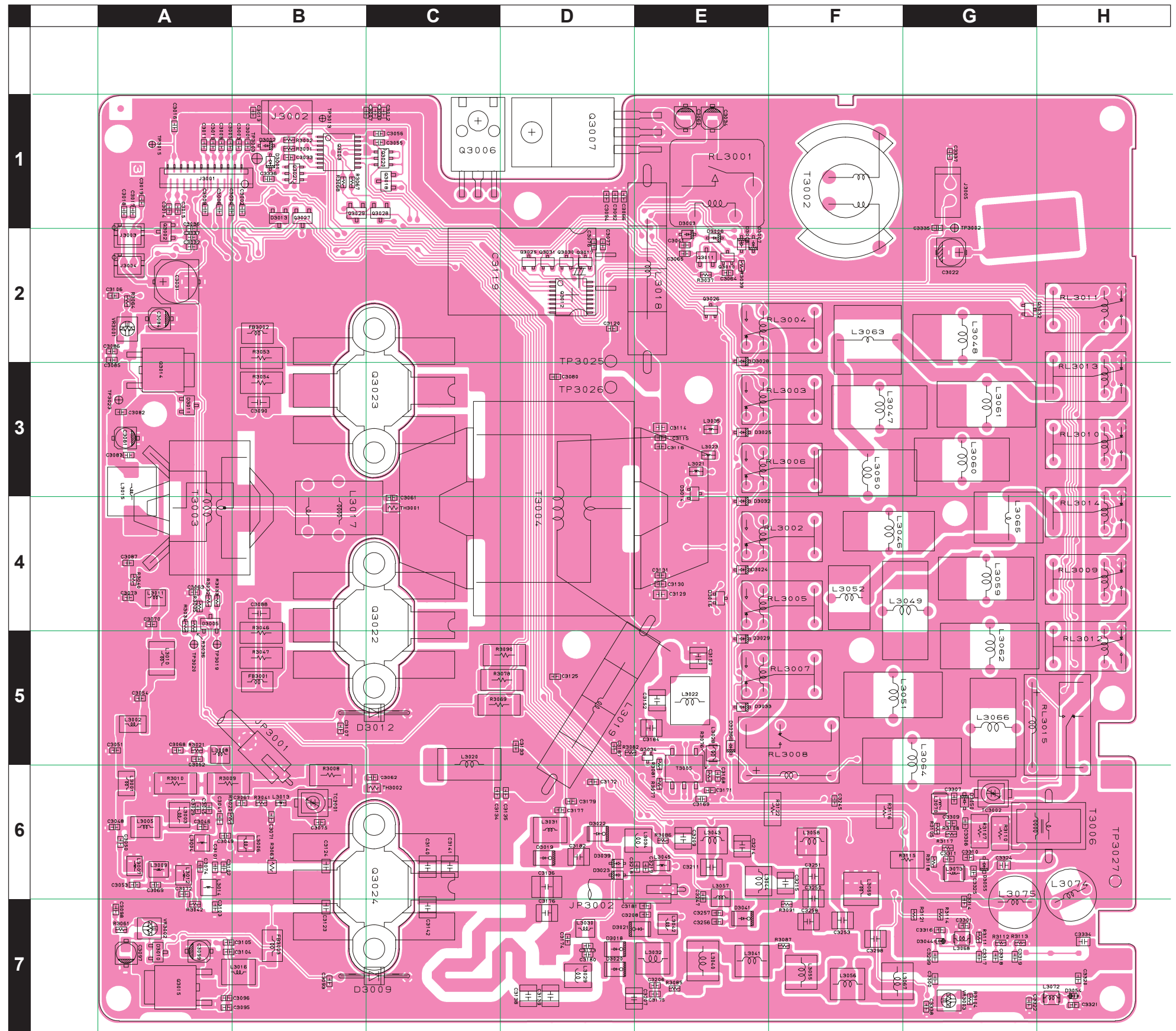
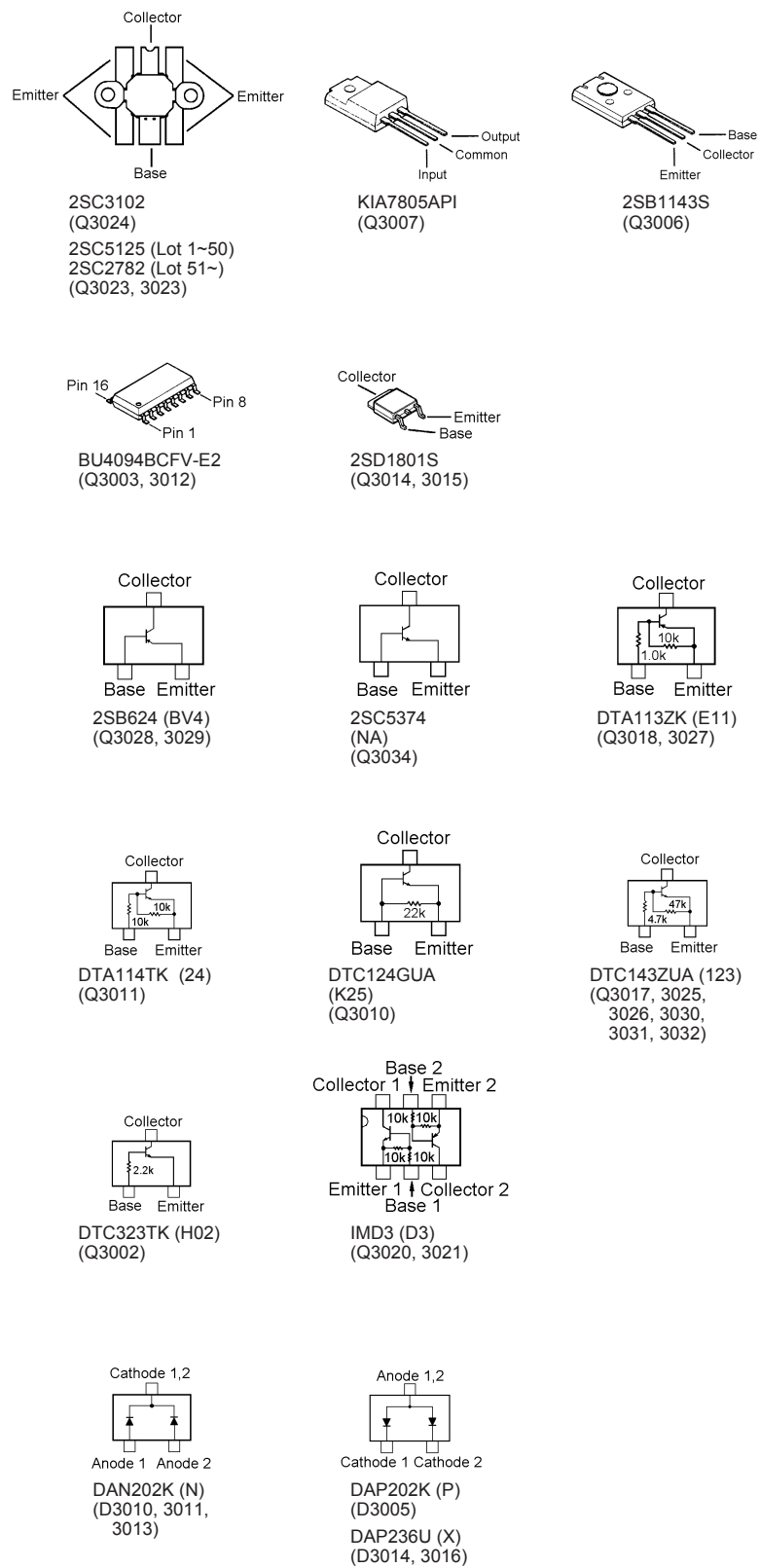

PA Unit (Lot 1 ~ 59)

Parts Layout

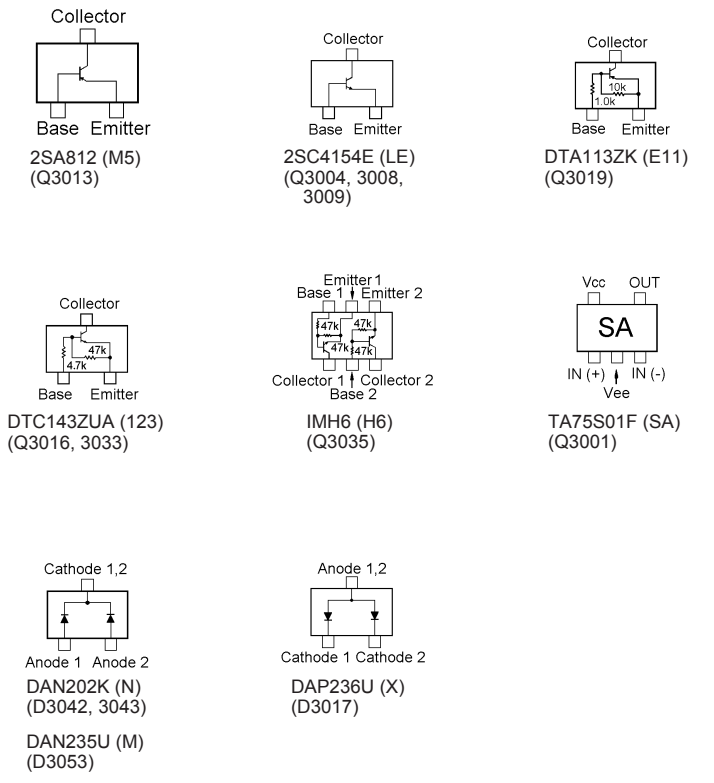
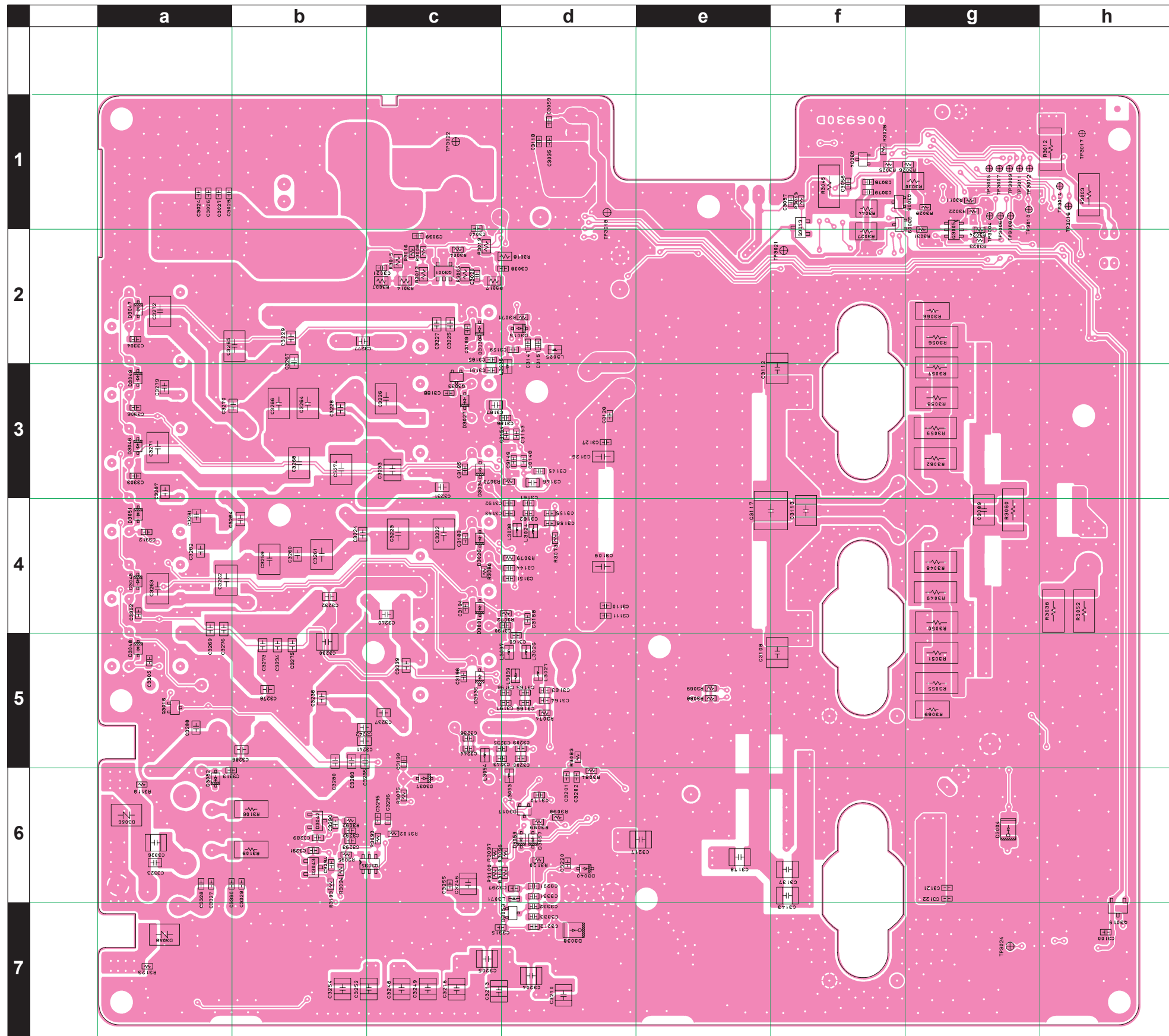

Side B

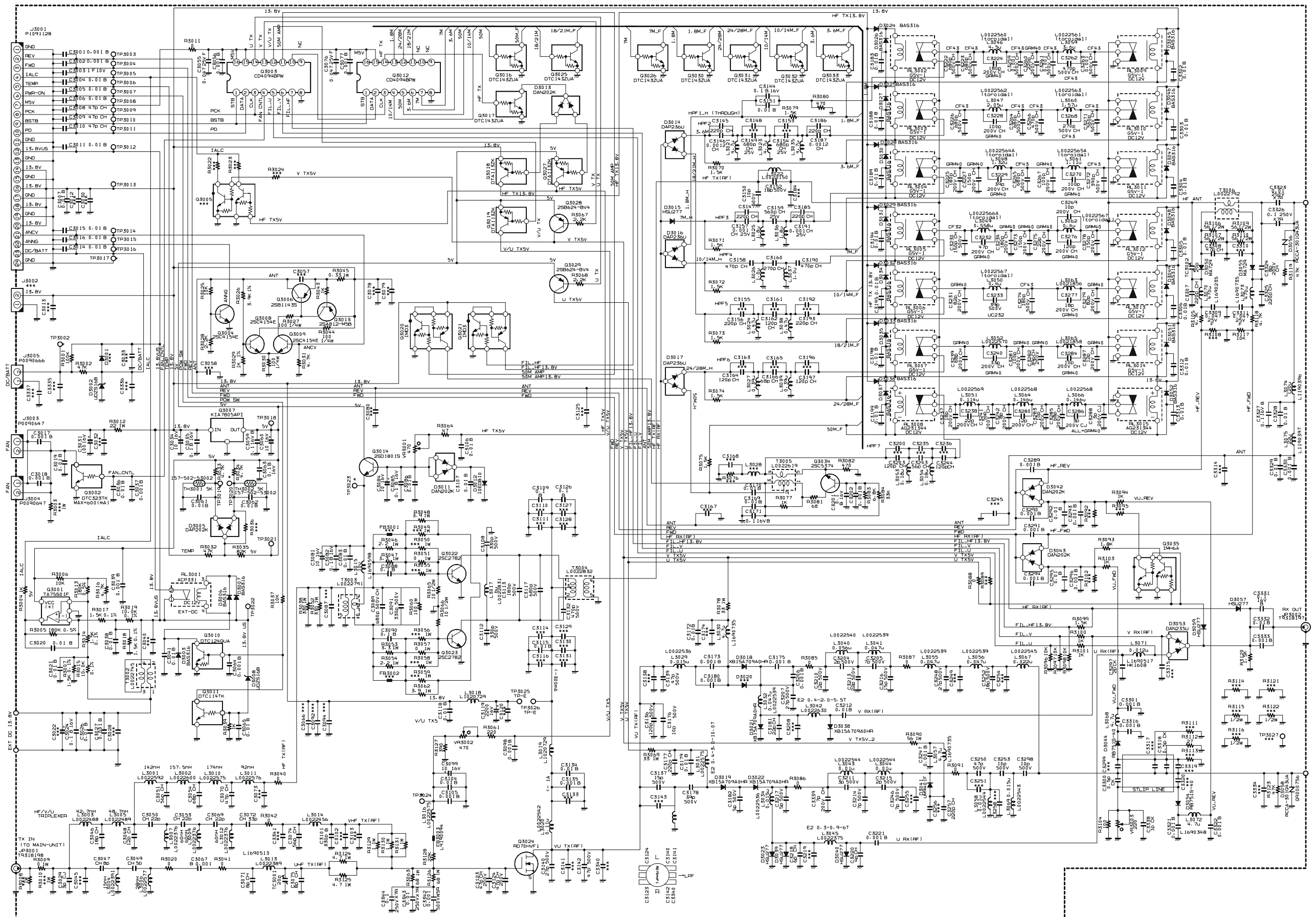

PA Unit (Lot 60 ~)

Note:

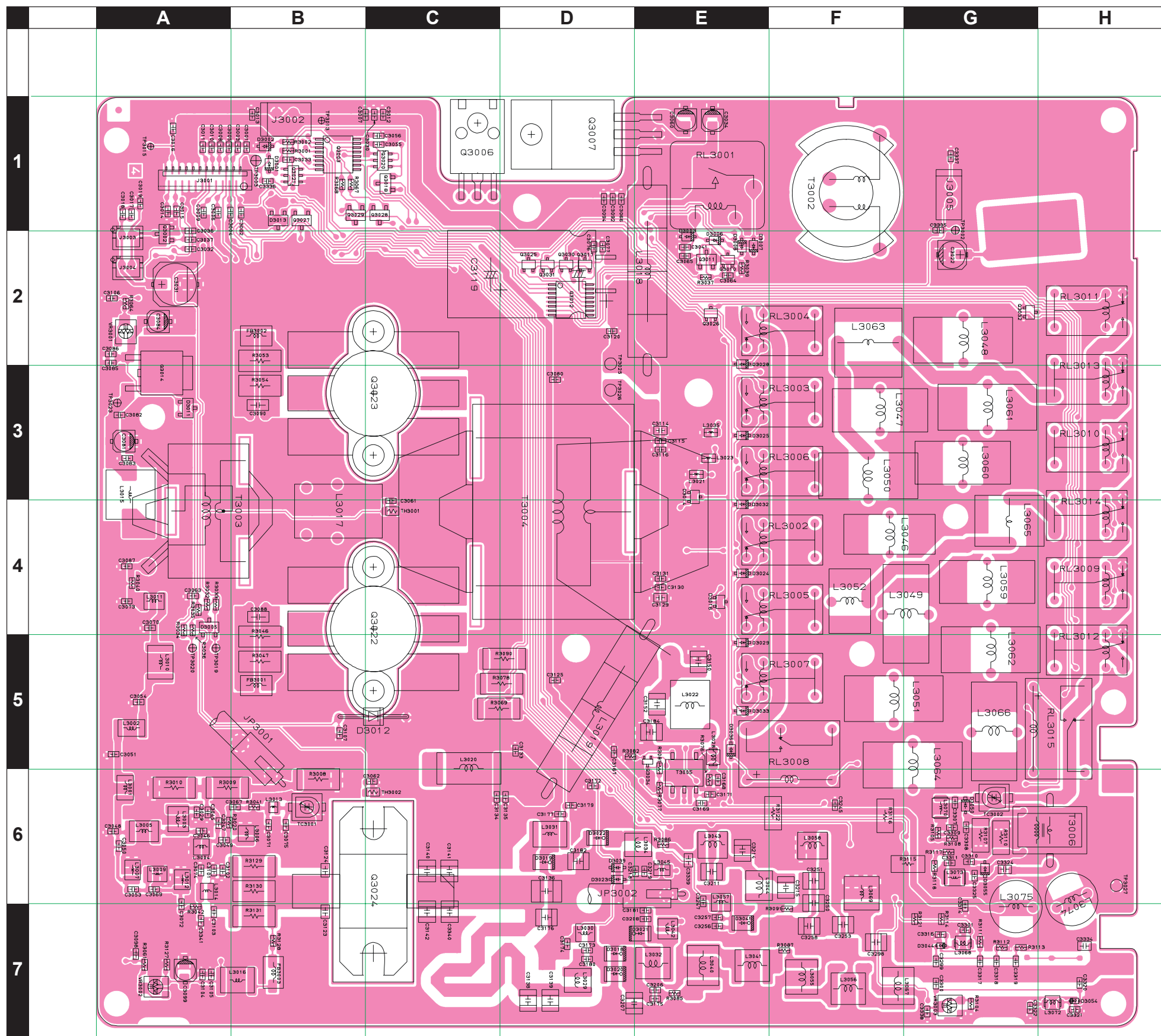
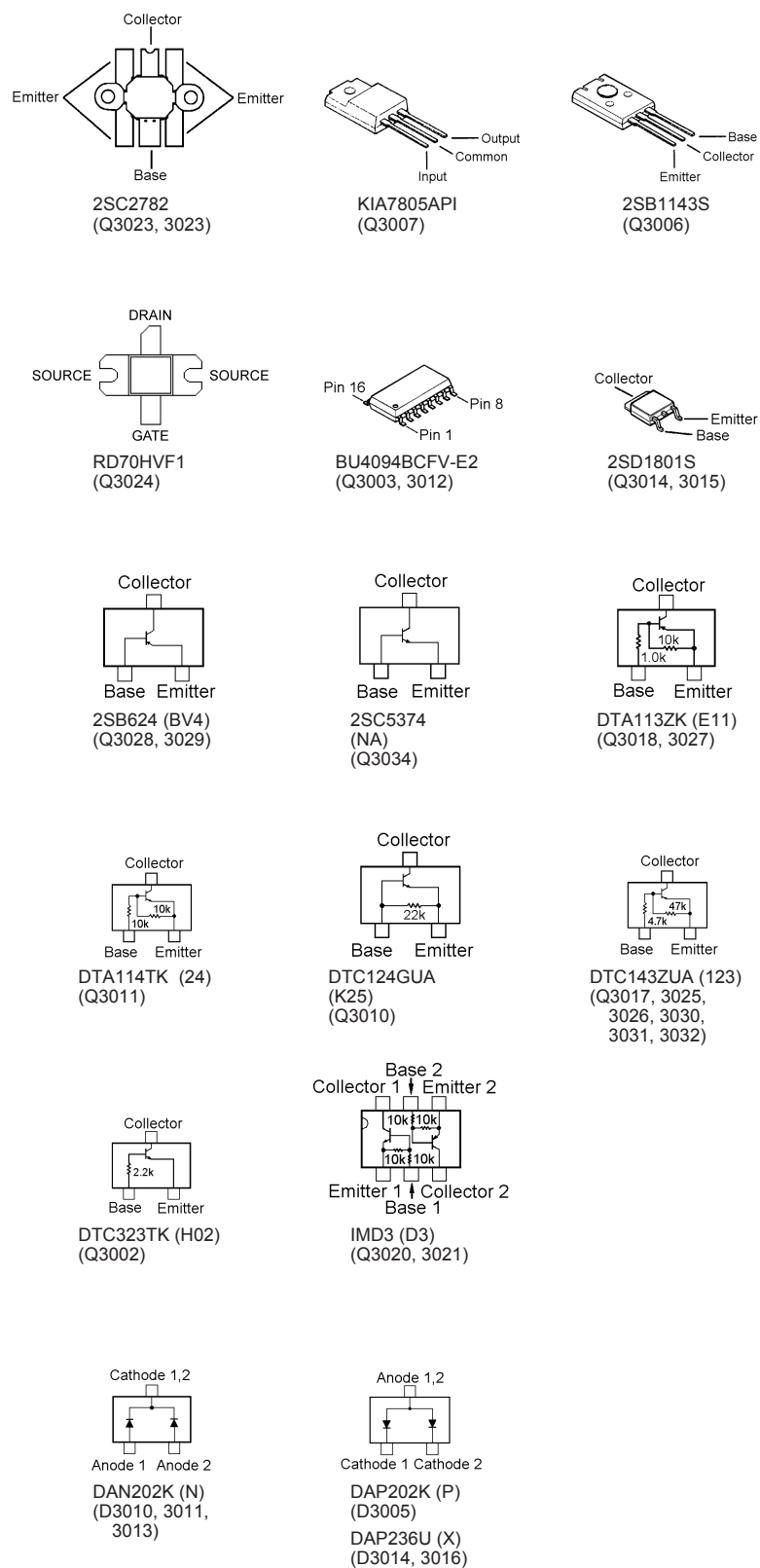

PA Unit (Lot 60 ~)

Parts Layout

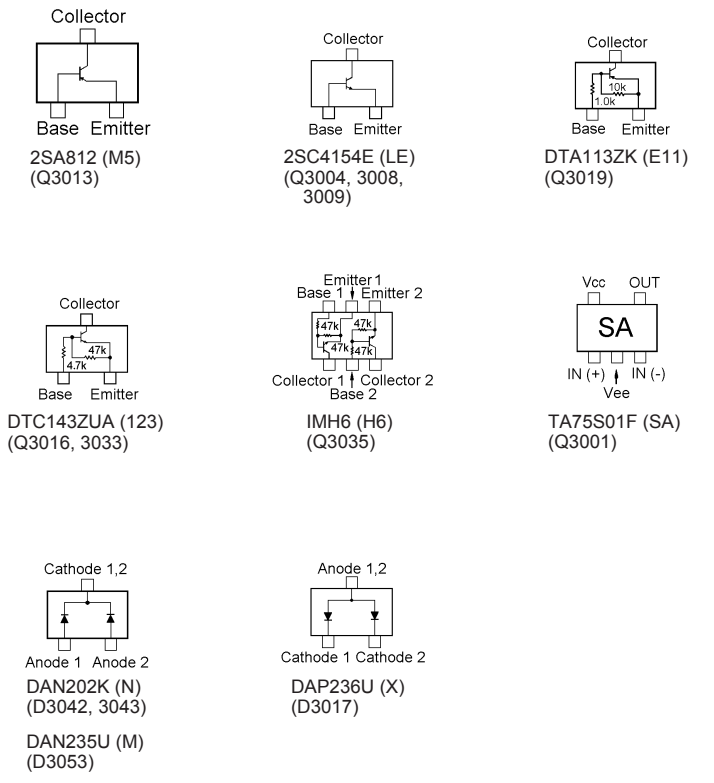
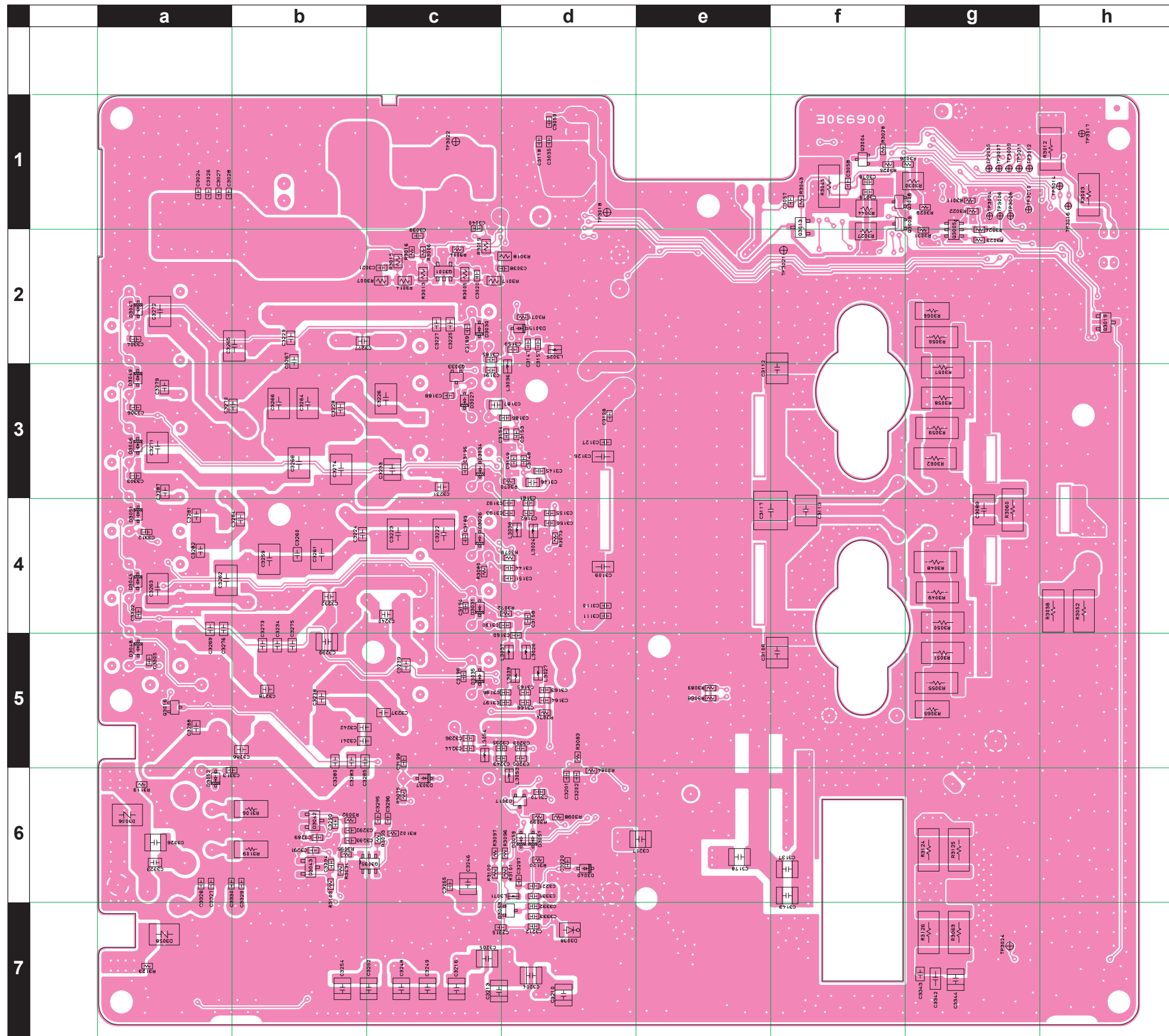

Side B

| REF | DESCRIPTION | VALUE | V/W | TOL. | MFR'S DESIG | VXSTD P/N | VERS. | LOT | SIDE | LAY | ADR |
|-----------------------|-----------------|---------|-----|------|--------------------|------------------------|-----------------------------|-----|------|-----|-----|
| PCB with Components | | | | | | CS1851002* | VER. USA (Lot 1-59) | | | | |
| | | | | | | CS1851003* | VER. EXP (CE OFF: Lot 1-59) | | | | |
| | | | | | | CS1851004* | VER. AUS (CE OFF: Lot 1-59) | | | | |
| | | | | | | CS1851005* | VER. FRA (CE OFF: Lot 1-59) | | | | |
| | | | | | | CS1851006* | VER. EXP (CE ON: Lot 1-59) | | | | |
| | | | | | | CS1851007* | VER. FRA (CE ON: Lot 1-59) | | | | |
| | | | | | | CS1869002 | VER. USA (Lot 60-) | | | | |
| | | | | | | CS1869003 | VER. EXP (CE OFF: Lot 60-) | | | | |
| | | | | | | CS1869004 | VER. AUS (CE OFF: Lot 60-) | | | | |
| | | | | | | CS1869005 | VER. FRA (CE OFF: Lot 60-) | | | | |
| | | | | | | CS1869006 | VER. EXP (CE ON: Lot 60-) | | | | |
| | | | | | | CS1869007 | VER. FRA (CE ON: Lot 60-) | | | | |
| | | | | | | *: W/O Q3022/3023/3024 | | | | | |
| Printed Circuit Board | | | | | AH007M000 | FR006930D | 1-59 | | | | |
| | | | | | AH007M000 | FR006930E | 60- | | | | |
| C 3001 | CHIP CAP. | 0.001uF | 50V | B | GRM188B11H102KA01D | K22174821 | | 1- | A | | G7 |
| C 3002 | CHIP CAP. | 0.001uF | 50V | B | GRM188B11H102KA01D | K22174821 | | 1- | A | | G6 |
| C 3003 | CHIP CAP. | 1uF | 10V | F | GRM188F11A105ZA01D | K22105001 | | 1- | A | | G7 |
| C 3004 | CHIP CAP. | 0.01uF | 50V | B | GRM188B11H103KA01D | K22174823 | | 1- | A | | G6 |
| C 3005 | CHIP CAP. | 0.01uF | 50V | B | GRM188B11H103KA01D | K22174823 | | 1- | A | | G7 |
| C 3006 | CHIP CAP. | 0.01uF | 50V | B | GRM188B11H103KA01D | K22174823 | | 1- | A | | G6 |
| C 3007 | CHIP CAP. | 0.01uF | 50V | B | GRM188B11H103KA01D | K22174823 | | 1- | A | | F7 |
| C 3008 | CHIP CAP. | 47pF | 50V | CH | GRM1882C1H470JA01D | K22174227 | | 1- | A | | G7 |
| C 3009 | CHIP CAP. | 47pF | 50V | CH | GRM1882C1H470JA01D | K22174227 | | 1- | A | | G6 |
| C 3010 | CHIP CAP. | 47pF | 50V | CH | GRM1882C1H470JA01D | K22174227 | | 1- | A | | G7 |
| C 3011 | CHIP CAP. | 0.01uF | 50V | B | GRM188B11H103KA01D | K22174823 | | 1- | A | | G7 |
| C 3014 | CHIP CAP. | 0.01uF | 50V | B | GRM188B11H103KA01D | K22174823 | | 1- | A | | H7 |
| C 3015 | CHIP CAP. | 0.01uF | 50V | B | GRM188B11H103KA01D | K22174823 | | 1- | A | | H7 |
| C 3016 | CHIP CAP. | 0.01uF | 50V | B | GRM188B11H103KA01D | K22174823 | | 1- | A | | H7 |
| C 3017 | CHIP CAP. | 0.001uF | 50V | B | GRM188B11H102KA01D | K22174821 | | 1- | A | | H6 |
| C 3018 | CHIP CAP. | 0.001uF | 50V | B | GRM188B11H102KA01D | K22174821 | | 1- | A | | H6 |
| C 3019 | CHIP CAP. | 0.01uF | 50V | B | GRM188B11H103KA01D | K22174823 | | 1- | A | | H7 |
| C 3020 | CHIP CAP. | 0.01uF | 50V | B | GRM188B11H103KA01D | K22174823 | | 1- | B | | e6 |
| C 3021 | CHIP CAP. | 0.01uF | 50V | B | GRM188B11H103KA01D | K22174823 | | 1- | B | | f6 |
| C 3022 | AL.ELECTRO.CAP. | 1uF | 50V | | ECEV1HA010SR | K48170019 | | 1 | A | | B6 |
| C 3022 | AL.ELECTRO.CAP. | 1uF | 50V | | ECEV1HA010SR | K48170019 | W/ CE | 2- | A | | B6 |
| C 3022 | AL.ELECTRO.CAP. | 1uF | 50V | | EEE1HA010SR | K48170027 | W/ CE | 69- | A | | B6 |
| C 3024 | CHIP CAP. | 0.1uF | 16V | B | GRM188B11C104KA01D | K22124805 | | 1- | B | | g7 |
| C 3026 | CHIP CAP. | 0.01uF | 50V | B | GRM188B11H103KA01D | K22174823 | | 1- | B | | g7 |
| C 3027 | CHIP CAP. | 0.001uF | 50V | B | GRM188B11H102KA01D | K22174821 | | 1- | B | | g7 |
| C 3029 | CHIP CAP. | 3pF | 50V | CJ | GRM1883C1H3R0CZ01D | K22174204 | | 1- | A | | G2 |
| C 3031 | AL.ELECTRO.CAP. | 100uF | 16V | | EEE1CA101WP | K48120012 | | 1- | A | | H6 |
| C 3034 | AL.ELECTRO.CAP. | 10uF | 16V | | RV2-16V100MB55U-R | K48120014 | | 1- | A | | D7 |
| C 3035 | CHIP CAP. | 0.1uF | 16V | B | GRM188B11C104KA01D | K22124805 | | 1- | B | | e7 |
| C 3036 | CHIP CAP. | 0.01uF | 50V | B | GRM188B11H103KA01D | K22174823 | | 1- | A | | H6 |
| C 3037 | CHIP CAP. | 0.001uF | 50V | B | GRM188B11H102KA01D | K22174821 | | 1- | A | | H6 |
| C 3038 | CHIP CAP. | 0.01uF | 50V | B | GRM188B11H103KA01D | K22174823 | | 1- | B | | e6 |
| C 3039 | CHIP CAP. | 0.001uF | 50V | B | GRM188B11H102KA01D | K22174821 | | 1- | B | | f6 |
| C 3041 | CHIP CAP. | 0.01uF | 50V | B | GRM188B11H103KA01D | K22174823 | | 1- | A | | D6 |
| C 3046 | CHIP CAP. | 18pF | 50V | CH | GRM1882C1H180JA01D | K22174217 | | 1- | A | | G2 |
| C 3047 | CHIP CAP. | 8pF | 50V | CH | GRM1882C1H8R0DZ01D | K22174209 | | 1- | A | | G2 |
| C 3048 | CHIP CAP. | 12pF | 50V | CH | GRM1882C1H120JA01D | K22174213 | | 1- | A | | H2 |
| C 3049 | CHIP CAP. | 5pF | 50V | CH | GRM1882C1H5R0CZ01D | K22174206 | | 1- | A | | G2 |
| C 3050 | CHIP CAP. | 22pF | 50V | CH | GRM1882C1H220JA01D | K22174219 | | 1- | A | | H2 |
| C 3051 | CHIP CAP. | 56pF | 50V | CH | GRM1882C1H560JA01D | K22174229 | | 1- | A | | H2 |
| C 3053 | CHIP CAP. | 22pF | 50V | CH | GRM1882C1H220JA01D | K22174219 | | 1- | A | | H1 |
| C 3054 | CHIP CAP. | 68pF | 50V | CH | GRM1882C1H680JA01D | K22174231 | | 1- | A | | H3 |
| C 3055 | CHIP CAP. | 0.047uF | 25V | F | GRM39F473Z25PT | K22145002 | | 1- | A | | F7 |
| C 3056 | CHIP CAP. | 0.001uF | 50V | B | GRM188B11H102KA01D | K22174821 | | 1- | A | | F7 |
| C 3059 | CHIP CAP. | 0.1uF | 16V | B | GRM188B11C104KA01D | K22124805 | | 1- | B | | e7 |
| C 3060 | AL.ELECTRO.CAP. | 10uF | 16V | | RV2-16V100MB55U-R | K48120014 | | 1- | A | | D7 |
| C 3061 | CHIP CAP. | 0.01uF | 50V | B | GRM188B11H103KA01D | K22174823 | | 1- | A | | F4 |
| C 3062 | CHIP CAP. | 0.01uF | 50V | B | GRM188B11H103KA01D | K22174823 | | 1- | A | | F2 |
| C 3063 | CHIP CAP. | 0.1uF | 16V | B | GRM188B11C104KA01D | K22124805 | | 1- | A | | H4 |
| C 3064 | CHIP CAP. | 0.001uF | 50V | B | GRM188B11H102KA01D | K22174821 | | 1- | A | | D6 |
| C 3065 | CHIP CAP. | 0.01uF | 50V | B | GRM188B11H103KA01D | K22174823 | | 1- | A | | D6 |
| C 3067 | CHIP CAP. | 0.001uF | 50V | B | GRM188B11H102KA01D | K22174821 | | 1- | A | | G2 |
| C 3069 | CHIP CAP. | 22pF | 50V | CH | GRM1882C1H220JA01D | K22174219 | | 1- | A | | H1 |
| C 3070 | CHIP CAP. | 47pF | 50V | CH | GRM1882C1H470JA01D | K22174227 | | 1- | A | | H3 |
| C 3071 | CHIP CAP. | 6pF | 50V | CH | GRM1882C1H6R0DZ01D | K22174207 | | 1- | A | | G2 |
| C 3071 | CHIP CAP. | 10pF | 50V | CH | GRM1882C1H100JA01D | K22174211 | | 60- | A | | G2 |
| C 3072 | CHIP CAP. | 33pF | 50V | CH | GRM1882C1H330JA01D | K22174223 | | 1- | A | | H1 |
| C 3074 | CHIP CAP. | 12pF | 50V | CH | GRM1882C1H120JA01D | K22174213 | | 1- | A | | G2 |

PA Unit

Parts List

| REF | DESCRIPTION | VALUE | V/W | TOL. | MFR'S DESIG | VXSTD P/N | VERS. | LOT | SIDE | LAY ADR |
|--------|-----------------|----------|------|------|--------------------|-----------|-------|------|------|---------|
| C 3074 | CHIP CAP. | 47pF | 50V | CH | GRM1882C1H470JA01D | K22174227 | | 60- | A | G2 |
| C 3075 | CHIP CAP. | 8pF | 50V | CH | GRM1882C1H8R0DZ01D | K22174209 | | 1- | A | G2 |
| C 3076 | CHIP CAP. | 0.047uF | 25V | F | GRM39F473Z25PT | K22145002 | | 1- | A | E6 |
| C 3077 | CHIP CAP. | 0.001uF | 50V | B | GRM188B11H102KA01D | K22174821 | | 1- | A | D6 |
| C 3081 | AL.ELECTRO.CAP. | 10uF | 16V | | RV2-16V100MB55U-R | K48120014 | | 1- | A | H5 |
| C 3082 | CHIP CAP. | 0.1uF | 16V | B | GRM188B11C104KA01D | K22124805 | | 1- | A | H5 |
| C 3083 | CHIP CAP. | 0.01uF | 50V | B | GRM188B11H103KA01D | K22174823 | | 1- | A | H5 |
| C 3084 | AL.ELECTRO.CAP. | 10uF | 16V | | RV2-16V100MB55U-R | K48120014 | | 1- | A | H6 |
| C 3085 | CHIP CAP. | 0.1uF | 16V | B | GRM188B11C104KA01D | K22124805 | | 1- | A | H5 |
| C 3086 | CHIP CAP. | 0.01uF | 50V | B | GRM188B11H103KA01D | K22174823 | | 1- | A | H5 |
| C 3088 | CHIP CAP. | 0.1uF | 50V | B | GRM42-6B104K50PT | K22171820 | | 1- | A | G3 |
| C 3089 | CHIP CAP. | 680pF | 500V | CH | CF43CH681J500AT | K22277218 | | 1- | B | b4 |
| C 3090 | CHIP CAP. | 0.1uF | 50V | B | GRM42-6B104K50PT | K22171820 | | 1- | A | G5 |
| C 3091 | FILM CAP. | 330pF | 500V | | UC342H3300J-T | K33279014 | | 1- | | |
| C 3093 | CHIP CAP. | 0.001uF | 50V | B | GRM188B11H102KA01D | K22174821 | | 1-59 | | |
| C 3095 | CHIP CAP. | 0.001uF | 50V | B | GRM188B11H102KA01D | K22174821 | | 1-59 | | |
| C 3096 | CHIP CAP. | 0.01uF | 50V | B | GRM188B11H103KA01D | K22174823 | | 1-59 | | |
| C 3097 | AL.ELECTRO.CAP. | 10uF | 16V | | RV2-16V100MB55U-R | K48120014 | | 1-59 | | |
| C 3098 | CHIP CAP. | 0.001uF | 50V | B | GRM188B11H102KA01D | K22174821 | | 1- | A | H1 |
| C 3099 | AL.ELECTRO.CAP. | 10uF | 16V | | RV2-16V100MB55U-R | K48120014 | | 1- | A | H1 |
| C 3100 | CHIP CAP. | 0.01uF | 50V | B | GRM188B11H103KA01D | K22174823 | | 1-59 | | |
| C 3101 | CHIP CAP. | 120pF | 50V | CH | GRM1882C1H121JA01D | K22174237 | | 1- | A | G2 |
| C 3101 | CHIP CAP. | 330pF | 50V | CH | GRM1882C1H331JA01D | K22174253 | | 60- | A | G2 |
| C 3102 | CHIP CAP. | 82pF | 50V | CH | GRM1882C1H820JA01D | K22174233 | | 1-59 | A | G2 |
| C 3104 | CHIP CAP. | 0.01uF | 50V | B | GRM188B11H103KA01D | K22174823 | | 1- | A | G1 |
| C 3105 | CHIP CAP. | 0.001uF | 50V | B | GRM188B11H102KA01D | K22174821 | | 1- | A | G1 |
| C 3106 | CHIP CAP. | 0.01uF | 50V | B | GRM188B11H103KA01D | K22174823 | | 1- | A | H6 |
| C 3107 | CHIP CAP. | 0.01uF | 50V | B | GRM188B11H103KA01D | K22174823 | | 1- | A | F3 |
| C 3108 | FILM CAP. | 330pF | 500V | | UC342H3300J-T | K33279014 | | 1- | B | c3 |
| C 3109 | CHIP CAP. | 0.1uF | 50V | B | GRM42-6B104K50PT | K22171820 | | 1- | B | d4 |
| C 3112 | FILM CAP. | 330pF | 500V | | UC342H3300J-T | K33279014 | | 1- | B | c5 |
| C 3113 | FILM CAP. | 180pF | 500V | | UC342H1800J-T | K33279039 | | 1- | B | c4 |
| C 3115 | CHIP CAP. | 0.01uF | 50V | B | GRM188B11H103KA01D | K22174823 | | 1- | A | D5 |
| C 3117 | FILM CAP. | 680pF | 500V | | UC552H6800J-T | K33279042 | | 1- | B | c4 |
| C 3118 | CHIP CAP. | 0.01uF | 50V | B | GRM188B11H103KA01D | K22174823 | | 1- | B | e7 |
| C 3119 | AL.ELECTRO.CAP. | 2200uF | 16V | | RE3-16V222MI5# | K40129064 | | 1- | A | D6 |
| C 3123 | CHIP CAP. | 47pF | 200V | CH | GRM2192C2D470JV01D | K22230224 | | 1- | A | G1 |
| C 3124 | CHIP CAP. | 47pF | 200V | CH | GRM2192C2D470JV01D | K22230224 | | 1- | A | G2 |
| C 3126 | CHIP CAP. | 0.1uF | 50V | B | GRM42-6B104K50PT | K22171820 | | 1- | B | d5 |
| C 3132 | FILM CAP. | 470pF | 500V | | UC342H4700J-T | K33279015 | | 1- | | |
| C 3133 | CHIP CAP. | 100pF | 50V | CH | GRM1882C1H101JA01D | K22174235 | W/ CE | 3- | A | E2 |
| C 3134 | CHIP CAP. | 0.01uF | 50V | B | GRM188B11H103KA01D | K22174823 | | 1- | A | E2 |
| C 3135 | CHIP CAP. | 0.001uF | 50V | B | GRM188B11H102KA01D | K22174821 | | 1- | A | E2 |
| C 3136 | FILM CAP. | 120pF | 500V | | UC342H1200J-T | K33279026 | | 1- | A | E1 |
| C 3137 | FILM CAP. | 15pF | 500V | | UC232H0150J-T | K33279028 | | 1- | B | c2 |
| C 3138 | FILM CAP. | 10pF | 500V | | UC232H0100D-T | K33279019 | | 1-59 | A | E1 |
| C 3139 | FILM CAP. | 47pF | 500V | | UC232H0470J-T | K33279034 | | 1- | A | E1 |
| C 3140 | FILM CAP. | 56pF | 500V | | UC232H0560J-T | K33279035 | | 1- | A | F2 |
| C 3140 | FILM CAP. | 27pF | 500V | | UC232H0270J-T | K33279023 | | 60- | A | F2 |
| C 3141 | FILM CAP. | 12pF | 500V | | UC232H0120J-T | K33279020 | | 1-59 | A | F2 |
| C 3142 | FILM CAP. | 47pF | 500V | | UC232H0470J-T | K33279034 | | 1- | A | F1 |
| C 3144 | CHIP CAP. | 0.1uF | 16V | B | GRM188B11C104KA01D | K22124805 | | 1- | B | e4 |
| C 3145 | CHIP CAP. | 220pF | 50V | CH | GRM1882C1H221JA01D | K22174243 | | 1- | B | e5 |
| C 3146 | CHIP CAP. | 0.0012uF | 50V | CH | GRM40CH122J50PT | K22170290 | | 1- | B | e4 |
| C 3147 | CHIP CAP. | 220pF | 50V | CH | GRM1882C1H221JA01D | K22174243 | | 1- | B | e6 |
| C 3149 | CHIP CAP. | 680pF | 25V | CH | GRM39CH681J25PT | K22144203 | | 1- | B | e5 |
| C 3150 | FILM CAP. | 18pF | 500V | | UC232H0180J-T | K33279029 | | 1-50 | A | D3 |
| C 3150 | FILM CAP. | 10pF | 500V | | UC232H0100D-T | K33279019 | | 53- | A | D3 |
| C 3151 | CHIP CAP. | 0.01uF | 50V | B | GRM188B11H103KA01D | K22174823 | | 1- | B | e4 |
| C 3152 | FILM CAP. | 8pF | 500V | | UC232H0080D-T | K33279005 | | 1- | A | D3 |
| C 3152 | FILM CAP. | 18pF | 500V | | UC232H0180J-T | K33279029 | | 5- | A | D3 |
| C 3154 | CHIP CAP. | 680pF | 25V | CH | GRM39CH681J25PT | K22144203 | | 1- | B | e5 |
| C 3156 | CHIP CAP. | 220pF | 50V | CH | GRM1882C1H221JA01D | K22174243 | | 1- | B | e4 |
| C 3157 | CHIP CAP. | 0.001uF | 25V | CH | GRM1882C1E102JA01D | K22144204 | | 1- | B | e6 |
| C 3158 | CHIP CAP. | 470pF | 50V | CH | GRM1882C1H471JA01D | K22174249 | | 1- | B | e3 |
| C 3159 | CHIP CAP. | 560pF | 25V | CH | GRM39CH561J25PT | K22144201 | | 1- | B | e5 |
| C 3160 | CHIP CAP. | 270pF | 50V | CH | GRM1882C1H271JA01D | K22174251 | | 1- | B | e3 |
| C 3162 | CHIP CAP. | 120pF | 50V | CH | GRM1882C1H121JA01D | K22174237 | | 1- | B | e4 |
| C 3164 | CHIP CAP. | 120pF | 50V | CH | GRM1882C1H121JA01D | K22174237 | | 1- | B | e3 |
| C 3166 | CHIP CAP. | 68pF | 50V | CH | GRM1882C1H680JA01D | K22174231 | | 1- | B | e3 |
| C 3169 | CHIP CAP. | 0.01uF | 50V | B | GRM188B11H103KA01D | K22174823 | | 1- | A | D2 |
| C 3170 | CHIP CAP. | 0.01uF | 50V | B | GRM188B11H103KA01D | K22174823 | | 1- | B | e2 |
| C 3171 | CHIP CAP. | 0.1uF | 16V | B | GRM188B11C104KA01D | K22124805 | | 1- | A | D2 |

| REF | DESCRIPTION | VALUE | V/W | TOL. | MFR'S DESIG | VXSTD P/N | VERS. | LOT | SIDE | LAY ADR |
|--------|-------------|----------|------|------|--------------------|-----------|--------|-----|------|---------|
| C 3172 | CHIP CAP. | 0.01uF | 50V | B | GRM188B11H103KA01D | K22174823 | | 1- | A | E2 |
| C 3173 | CHIP CAP. | 0.001uF | 50V | B | GRM188B11H102KA01D | K22174821 | | 1- | A | E1 |
| C 3175 | CHIP CAP. | 0.001uF | 50V | B | GRM188B11H102KA01D | K22174821 | | 1- | A | D1 |
| C 3176 | FILM CAP. | 10pF | 500V | | UC232H0100D-T | K33279019 | | 60- | A | E1 |
| C 3177 | CHIP CAP. | 220pF | 50V | CH | GRM1882C1H221JA01D | K22174243 | | 1- | A | E2 |
| C 3178 | FILM CAP. | 39pF | 500V | | UC232H0390J-T | K33279038 | | 1- | B | c2 |
| C 3179 | CHIP CAP. | 0.01uF | 50V | B | GRM188B11H103KA01D | K22174823 | | 1- | A | E2 |
| C 3180 | CHIP CAP. | 0.001uF | 50V | B | GRM188B11H102KA01D | K22174821 | | 1- | A | E1 |
| C 3181 | CHIP CAP. | 22pF | 50V | CH | GRM1882C1H220JA01D | K22174219 | | 1- | A | D1 |
| C 3182 | FILM CAP. | 5pF | 500V | | UC232H0050D-T | K33279010 | | 1- | A | E2 |
| C 3182 | FILM CAP. | 6pF | 500V | | UC232H0060D-T | K33279045 | | 64- | A | E2 |
| C 3183 | CHIP CAP. | 0.01uF | 50V | B | GRM188B11H103KA01D | K22174823 | | 1- | B | f4 |
| C 3185 | CHIP CAP. | 220pF | 50V | CH | GRM1882C1H221JA01D | K22174243 | | 1- | B | e5 |
| C 3186 | CHIP CAP. | 220pF | 50V | CH | GRM1882C1H221JA01D | K22174243 | | 1- | B | e5 |
| C 3187 | CHIP CAP. | 0.0012uF | 50V | CH | GRM40CH122J50PT | K22170290 | | 1- | B | e5 |
| C 3188 | CHIP CAP. | 0.01uF | 50V | B | GRM188B11H103KA01D | K22174823 | | 1- | B | f5 |
| C 3189 | CHIP CAP. | 0.01uF | 50V | B | GRM188B11H103KA01D | K22174823 | | 1- | B | e6 |
| C 3190 | CHIP CAP. | 470pF | 50V | CH | GRM1882C1H471JA01D | K22174249 | | 1- | B | e3 |
| C 3191 | CHIP CAP. | 0.001uF | 25V | CH | GRM1882C1E102JA01D | K22144204 | | 1- | B | e5 |
| C 3193 | CHIP CAP. | 220pF | 50V | CH | GRM1882C1H221JA01D | K22174243 | | 1- | B | e4 |
| C 3194 | CHIP CAP. | 0.01uF | 50V | B | GRM188B11H103KA01D | K22174823 | | 1- | B | f4 |
| C 3195 | CHIP CAP. | 0.01uF | 50V | B | GRM188B11H103KA01D | K22174823 | | 1- | B | f5 |
| C 3197 | CHIP CAP. | 120pF | 50V | CH | GRM1882C1H121JA01D | K22174237 | | 1- | B | e3 |
| C 3198 | CHIP CAP. | 0.01uF | 50V | B | GRM188B11H103KA01D | K22174823 | | 1- | B | f3 |
| C 3199 | CHIP CAP. | 0.01uF | 50V | B | GRM188B11H103KA01D | K22174823 | | 1- | B | f2 |
| C 3201 | CHIP CAP. | 0.1uF | 16V | B | GRM188B11C104KA01D | K22124805 | | 1- | B | e2 |
| C 3202 | CHIP CAP. | 0.001uF | 50V | B | GRM188B11H102KA01D | K22174821 | | 1- | B | e2 |
| C 3203 | CHIP CAP. | 120pF | 50V | CH | GRM1882C1H121JA01D | K22174237 | | 1- | B | e3 |
| C 3204 | FILM CAP. | 2pF | 500V | | UC232H0020D-T | K33279043 | | 1- | B | e1 |
| C 3205 | FILM CAP. | 7pF | 500V | | UC232H0070D-T | K33279046 | | 1- | B | e1 |
| C 3206 | CHIP CAP. | 0.001uF | 50V | B | GRM188B11H102KA01D | K22174821 | | 1- | A | D1 |
| C 3207 | FILM CAP. | 27pF | 500V | | UC232H0270J-T | K33279023 | | 1- | A | D1 |
| C 3210 | FILM CAP. | 12pF | 500V | | UC232H0120J-T | K33279020 | | 1- | B | e1 |
| C 3211 | FILM CAP. | 3pF | 500V | | UC232H0030D-T | K33279027 | | 1- | A | D2 |
| C 3212 | CHIP CAP. | 0.01uF | 50V | B | GRM188B11H103KA01D | K22174823 | | 1- | B | e1 |
| C 3213 | FILM CAP. | 22pF | 500V | | UC232H0220J-T | K33279021 | | 1- | B | e1 |
| C 3214 | FILM CAP. | 7pF | 500V | | UC232H0070D-T | K33279046 | | 1- | A | C2 |
| C 3215 | FILM CAP. | 2pF | 500V | | UC232H0020D-T | K33279043 | | 1- | A | C1 |
| C 3216 | FILM CAP. | 15pF | 500V | | UC232H0150J-T | K33279028 | | 1- | B | f1 |
| C 3217 | FILM CAP. | 5pF | 500V | | UC232H0050D-T | K33279010 | | 1- | B | d2 |
| C 3218 | CHIP CAP. | 6pF | 50V | CH | GRM1882C1H6R0DZ01D | K22174207 | | 1- | A | D2 |
| C 3220 | CHIP CAP. | 4pF | 50V | CH | GRM1882C1H4R0CZ01D | K22174205 | | 1- | B | e2 |
| C 3221 | CHIP CAP. | 0.001uF | 50V | B | GRM188B11H102KA01D | K22174821 | | 1- | B | e1 |
| C 3222 | CHIP CAP. | 680pF | 500V | CH | CF43CH681J500AT | K22277218 | | 1- | B | f4 |
| C 3223 | CHIP CAP. | 680pF | 500V | CH | CF43CH681J500AT | K22277218 | | 1- | B | f4 |
| C 3224 | CHIP CAP. | 180pF | 200V | CH | GRM21B2C2D181JY21L | K22230231 | | 1- | B | f4 |
| C 3225 | CHIP CAP. | 180pF | 200V | CH | GRM21B2C2D181JY21L | K22230231 | | 1- | B | f6 |
| C 3226 | CHIP CAP. | 680pF | 500V | CH | CF43CH681J500AT | K22277218 | | 1- | B | f5 |
| C 3227 | CHIP CAP. | 150pF | 200V | CH | GRM21B2C2D151JV01L | K22230230 | | 1- | B | f6 |
| C 3228 | CHIP CAP. | 100pF | 200V | CH | GRM21B2C2D101JV01L | K22230228 | | 1- | B | f5 |
| C 3229 | CHIP CAP. | 39pF | 200V | CH | GRM2192C2D390JV01D | K22230223 | | 1- | B | g6 |
| C 3230 | CHIP CAP. | 150pF | 500V | CH | CF32CH151J500AT | K22275249 | | 1- | B | g3 |
| C 3231 | CHIP CAP. | 82pF | 200V | CH | GRM21B2C2D820JV01L | K22230227 | | 1- | B | f4 |
| C 3232 | CHIP CAP. | 47pF | 200V | CH | GRM2192C2D470JV01D | K22230224 | | 1- | B | g4 |
| C 3233 | FILM CAP. | 39pF | 500V | | UC232H0390J-T | K33279038 | | 1-2 | B | f5 |
| C 3233 | FILM CAP. | 33pF | 500V | | UC232H0330J-T | K33279024 | W/ CE | 3- | B | f5 |
| C 3233 | FILM CAP. | 39pF | 500V | | UC232H0390J-T | K33279038 | W/O CE | 3- | B | f5 |
| C 3234 | CHIP CAP. | 180pF | 200V | CH | GRM21B2C2D181JY21L | K22230231 | | 1- | B | g3 |
| C 3237 | CHIP CAP. | 18pF | 200V | CH | GRM2192C2D180JV01D | K22230219 | | 1- | B | f3 |
| C 3238 | CHIP CAP. | 22pF | 200V | CH | GRM2192C2D220JV01D | K22230220 | | 1- | B | g3 |
| C 3239 | CHIP CAP. | 68pF | 200V | CH | GRM21B2C2D680JV01L | K22230226 | | 1- | B | f3 |
| C 3240 | CHIP CAP. | 33pF | 200V | CH | GRM2192C2D330JV01D | K22230222 | | 1- | B | f3 |
| C 3241 | CHIP CAP. | 56pF | 200V | CH | GRM2192C2D560JV01D | K22230225 | | 1- | B | f3 |
| C 3242 | CHIP CAP. | 8pF | 200V | CH | GRM2192C2D8R0DY21D | K22230214 | | 1- | B | f3 |
| C 3243 | CHIP CAP. | 56pF | 50V | CH | GRM1882C1H560JA01D | K22174229 | | 1- | B | e2 |
| C 3244 | CHIP CAP. | 120pF | 50V | CH | GRM1882C1H121JA01D | K22174237 | | 1- | B | e3 |
| C 3246 | FILM CAP. | 7pF | 500V | | UC232H0070D-T | K33279046 | | 1- | B | e1 |
| C 3246 | FILM CAP. | 10pF | 500V | | UC232H0100D-T | K33279019 | | 4 | B | e1 |
| C 3246 | FILM CAP. | 7pF | 500V | | UC232H0070D-T | K33279046 | | 5- | B | e1 |
| C 3246 | FILM CAP. | 10pF | 500V | | UC232H0100D-T | K33279019 | | 18- | B | e1 |
| C 3246 | FILM CAP. | 7pF | 500V | | UC232H0070D-T | K33279046 | | 23- | B | e1 |
| C 3247 | CHIP CAP. | 0.001uF | 50V | B | GRM188B11H102KA01D | K22174821 | | 1- | A | D1 |
| C 3248 | FILM CAP. | 27pF | 500V | | UC232H0270J-T | K33279023 | | 1- | B | f1 |

PA Unit

Parts List

| REF | DESCRIPTION | VALUE | V/W | TOL. | MFR'S DESIG | VXSTD P/N | VERS. | LOT | SIDE | LAY ADR |
|--------|-------------|---------|------|------|--------------------|-----------|--------------|-------|------|---------|
| C 3250 | FILM CAP. | 47pF | 500V | | UC232H0470J-T | K33279034 | | 1- | A | C1 |
| C 3252 | FILM CAP. | 18pF | 500V | | UC232H0180J-T | K33279029 | | 1- | B | f1 |
| C 3253 | FILM CAP. | 10pF | 500V | | UC232H0100D-T | K33279019 | | 1- | A | C1 |
| C 3256 | CHIP CAP. | 0.001uF | 50V | B | GRM188B11H102KA01D | K22174821 | | 64- | A | D1 |
| C 3257 | CHIP CAP. | 220pF | 50V | CH | GRM1882C1H221JA01D | K22174243 | | 1- | A | D1 |
| C 3259 | CHIP CAP. | 0.001uF | 500V | CH | CF43CH102J500AT | K22277222 | | 1- | B | g4 |
| C 3260 | CHIP CAP. | 220pF | 200V | CH | GRM21B2C2D221JY21L | K22230232 | | 1- | B | g4 |
| C 3261 | CHIP CAP. | 0.001uF | 500V | CH | CF43CH102J500AT | K22277222 | | 1- | B | g4 |
| C 3262 | CHIP CAP. | 470pF | 500V | CH | CF43CH471J500AT | K22277214 | | 1- | B | g4 |
| C 3263 | CHIP CAP. | 0.001uF | 500V | CH | CF43CH102J500AT | K22277222 | | 1- | B | h4 |
| C 3264 | CHIP CAP. | 680pF | 500V | CH | CF43CH681J500AT | K22277218 | | 1- | B | g5 |
| C 3265 | CHIP CAP. | 680pF | 500V | CH | CF43CH681J500AT | K22277218 | | 1- | B | g5 |
| C 3266 | CHIP CAP. | 470pF | 500V | CH | CF43CH471J500AT | K22277214 | | 1- | B | g5 |
| C 3267 | CHIP CAP. | 100pF | 200V | CH | GRM21B2C2D101JV01L | K22230228 | | 1- | B | g5 |
| C 3268 | CHIP CAP. | 270pF | 500V | CH | CF43CH271J500AT | K22277208 | | 1- | B | g5 |
| C 3269 | CHIP CAP. | 10pF | 200V | CH | GRM2192C2D100JV01D | K22230216 | | 1- | B | g3 |
| C 3270 | CHIP CAP. | 100pF | 200V | CH | GRM21B2C2D101JV01L | K22230228 | | 1- | B | g5 |
| C 3271 | CHIP CAP. | 560pF | 500V | CH | CF43CH561J500AT | K22277216 | | 1- | B | h5 |
| C 3272 | CHIP CAP. | 390pF | 500V | CH | CF43CH391J500AT | K22277212 | | 1- | B | h6 |
| C 3273 | CHIP CAP. | 150pF | 200V | CH | GRM21B2C2D151JV01L | K22230230 | | 1- | B | g3 |
| C 3274 | CHIP CAP. | 220pF | 500V | CH | CF43CH221J500AT | K22277206 | | 1- | B | f5 |
| C 3274 | CHIP CAP. | 180pF | 500V | CH | CF43CH181J500AT | K22277204 | | 12- | B | f5 |
| C 3275 | CHIP CAP. | 22pF | 200V | CH | GRM2192C2D220JV01D | K22230220 | | 1- | B | g3 |
| C 3276 | CHIP CAP. | 120pF | 200V | CH | GRM21B2C2D121JV01L | K22230229 | | 1- | B | g3 |
| C 3277 | CHIP CAP. | 22pF | 200V | CH | GRM2192C2D220JV01D | K22230220 | W/ CE | 1- | B | f6 |
| C 3277 | CHIP CAP. | 18pF | 200V | CH | GRM2192C2D180JV01D | K22230219 | W/O CE | 1- | B | f6 |
| C 3278 | CHIP CAP. | 150pF | 200V | CH | GRM21B2C2D151JV01L | K22230230 | | 1- | B | g3 |
| C 3279 | CHIP CAP. | 82pF | 200V | CH | GRM21B2C2D820JV01L | K22230227 | | 1- | B | h5 |
| C 3280 | CHIP CAP. | 12pF | 200V | CH | GRM2192C2D120JV01D | K22230217 | | 1- | B | f2 |
| C 3281 | CHIP CAP. | 100pF | 200V | CH | GRM21B2C2D101JV01L | K22230228 | | 1- | B | h4 |
| C 3282 | CHIP CAP. | 39pF | 200V | CH | GRM2192C2D390JV01D | K22230223 | | 1- | B | g4 |
| C 3283 | CHIP CAP. | 10pF | 200V | CH | GRM2192C2D100JV01D | K22230216 | | 1- | B | f2 |
| C 3284 | CHIP CAP. | 10pF | 200V | CH | GRM2192C2D100JV01D | K22230216 | | 1- | B | g4 |
| C 3285 | CHIP CAP. | 68pF | 200V | CH | GRM21B2C2D680JV01L | K22230226 | | 1- | B | f2 |
| C 3286 | CHIP CAP. | 3pF | 200V | CJ | GRM2193C2D3R0CY21D | K22230210 | | 1- | B | g2 |
| C 3287 | CHIP CAP. | 12pF | 200V | CH | GRM2192C2D120JV01D | K22230217 | | 1- | B | h4 |
| C 3288 | CHIP CAP. | 3pF | 200V | CJ | GRM2193C2D3R0CY21D | K22230210 | | 1-76 | B | h3 |
| C 3288 | CHIP CAP. | 3pF | 200V | CJ | GRM2193C2D3R0CY21D | K22230210 | VER A2 (EXP) | 77-78 | B | h3 |
| C 3288 | CHIP CAP. | 27pF | 200V | CH | GRM2192C2D270JV01D | K22230221 | VER. FH | 77-78 | B | h3 |
| C 3288 | CHIP CAP. | 3pF | 200V | CJ | GRM2193C2D3R0CY21D | K22230210 | VER. A1 | 77-78 | B | h3 |
| C 3288 | CHIP CAP. | 3pF | 200V | CJ | GRM2193C2D3R0CY21D | K22230210 | VER. A2 | 77-78 | B | h3 |
| C 3288 | CHIP CAP. | 3pF | 200V | CJ | GRM2193C2D3R0CY21D | K22230210 | VER. A3 | 77-78 | B | h3 |
| C 3288 | CHIP CAP. | 3pF | 200V | CJ | GRM2193C2D3R0CY21D | K22230210 | VER. B1 | 77-78 | B | h3 |
| C 3288 | CHIP CAP. | 3pF | 200V | CJ | GRM2193C2D3R0CY21D | K22230210 | VER. B2 | 77-78 | B | h3 |
| C 3288 | CHIP CAP. | 3pF | 200V | CJ | GRM2193C2D3R0CY21D | K22230210 | VER. B3 | 77-78 | B | h3 |
| C 3288 | CHIP CAP. | 3pF | 200V | CJ | GRM2193C2D3R0CY21D | K22230210 | VER. C1 | 77-78 | B | h3 |
| C 3288 | CHIP CAP. | 3pF | 200V | CJ | GRM2193C2D3R0CY21D | K22230210 | VER. C2 | 77-78 | B | h3 |
| C 3288 | CHIP CAP. | 3pF | 200V | CJ | GRM2193C2D3R0CY21D | K22230210 | VER. C3 | 77-78 | B | h3 |
| C 3288 | CHIP CAP. | 3pF | 200V | CJ | GRM2193C2D3R0CY21D | K22230210 | VER. D1 | 77-78 | B | h3 |
| C 3288 | CHIP CAP. | 3pF | 200V | CJ | GRM2193C2D3R0CY21D | K22230210 | VER. D2 | 77-78 | B | h3 |
| C 3288 | CHIP CAP. | 3pF | 200V | CJ | GRM2193C2D3R0CY21D | K22230210 | VER. E1 | 77-78 | B | h3 |
| C 3288 | CHIP CAP. | 3pF | 200V | CJ | GRM2193C2D3R0CY21D | K22230210 | VER. E2 | 77-78 | B | h3 |
| C 3288 | CHIP CAP. | 3pF | 200V | CJ | GRM2193C2D3R0CY21D | K22230210 | VER. E3 | 77-78 | B | h3 |
| C 3288 | CHIP CAP. | 3pF | 200V | CJ | GRM2193C2D3R0CY21D | K22230210 | VER. F | 77-78 | B | h3 |
| C 3288 | CHIP CAP. | 3pF | 200V | CJ | GRM2193C2D3R0CY21D | K22230210 | VER. FM | 77-78 | B | h3 |
| C 3288 | CHIP CAP. | 3pF | 200V | CJ | GRM2193C2D3R0CY21D | K22230210 | VER. H1 | 77-78 | B | h3 |
| C 3288 | CHIP CAP. | 3pF | 200V | CJ | GRM2193C2D3R0CY21D | K22230210 | VER. H2 | 77-78 | B | h3 |
| C 3288 | CHIP CAP. | 27pF | 200V | CH | GRM2192C2D270JV01D | K22230221 | | 79- | B | h3 |
| C 3289 | CHIP CAP. | 0.001uF | 50V | B | GRM188B11H102KA01D | K22174821 | | 1- | B | g2 |
| C 3290 | CHIP CAP. | 0.001uF | 50V | B | GRM188B11H102KA01D | K22174821 | | 1- | B | f2 |
| C 3291 | CHIP CAP. | 0.001uF | 50V | B | GRM188B11H102KA01D | K22174821 | | 1- | B | g2 |
| C 3292 | CHIP CAP. | 0.01uF | 50V | B | GRM188B11H103KA01D | K22174823 | | 1- | B | f2 |
| C 3293 | CHIP CAP. | 0.001uF | 50V | B | GRM188B11H102KA01D | K22174821 | | 1- | B | f2 |
| C 3294 | CHIP CAP. | 0.001uF | 50V | B | GRM188B11H102KA01D | K22174821 | | 1- | B | f2 |
| C 3295 | CHIP CAP. | 0.01uF | 50V | B | GRM188B11H103KA01D | K22174823 | | 1- | B | f2 |
| C 3296 | CHIP CAP. | 0.001uF | 50V | B | GRM188B11H102KA01D | K22174821 | | 1- | B | f2 |
| C 3297 | CHIP CAP. | 2pF | 50V | CK | GRM1884C1H2R0CZ01D | K22174203 | | 1- | B | e2 |
| C 3298 | FILM CAP. | 10pF | 500V | | UC232H0100D-T | K33279019 | | 1- | A | B1 |
| C 3300 | CHIP CAP. | 0.5pF | 50V | CK | GRM1884C1HR50CZ01D | K22174201 | | 1 | A | B1 |
| C 3300 | CHIP CAP. | 0.5pF | 50V | CK | GRM1884C1HR50BZ01D | K22174265 | | 2- | A | B1 |
| C 3301 | CHIP CAP. | 0.001uF | 50V | B | GRM188B11H102KA01D | K22174821 | | 1- | A | B1 |
| C 3302 | CHIP CAP. | 0.01uF | 50V | B | GRM188B11H103KA01D | K22174823 | | 1- | B | h4 |
| C 3303 | CHIP CAP. | 0.01uF | 50V | B | GRM188B11H103KA01D | K22174823 | | 1- | B | h5 |

| REF | DESCRIPTION | VALUE | V/W | TOL. | MFR'S DESIG | VXSTD P/N | VERS. | LOT | SIDE | LAY ADR |
|--------|-------------|---------|------|------|--------------------|-----------|---------|-------|------|---------|
| C 3304 | CHIP CAP. | 0.01uF | 50V | B | GRM188B11H103KA01D | K22174823 | | 1- | B | h6 |
| C 3305 | CHIP CAP. | 0.01uF | 50V | B | GRM188B11H103KA01D | K22174823 | | 1- | B | h3 |
| C 3306 | CHIP CAP. | 0.01uF | 50V | B | GRM188B11H103KA01D | K22174823 | | 1- | B | h5 |
| C 3307 | CHIP CAP. | 220pF | 50V | CH | GRM1882C1H221JA01D | K22174243 | | 1- | A | B2 |
| C 3308 | CHIP CAP. | 47pF | 50V | CH | GRM1882C1H470JA01D | K22174227 | | 1- | A | B2 |
| C 3309 | CHIP CAP. | 0.047uF | 25V | F | GRM39F473Z25PT | K22145002 | | 1- | A | B2 |
| C 3311 | CHIP CAP. | 0.047uF | 25V | F | GRM39F473Z25PT | K22145002 | | 1- | A | B2 |
| C 3312 | CHIP CAP. | 0.01uF | 50V | B | GRM188B11H103KA01D | K22174823 | | 1- | B | h4 |
| C 3313 | CHIP CAP. | 0.01uF | 50V | B | GRM188B11H103KA01D | K22174823 | | 1- | B | g2 |
| C 3316 | CHIP CAP. | 0.001uF | 50V | B | GRM188B11H102KA01D | K22174821 | | 1- | A | B1 |
| C 3318 | CHIP CAP. | 0.5pF | 50V | CK | GRM1884C1HR50CZ01D | K22174201 | | 1 | A | B1 |
| C 3318 | CHIP CAP. | 0.5pF | 50V | CK | GRM1884C1HR50BZ01D | K22174265 | | 2- | A | B1 |
| C 3321 | CHIP CAP. | 0.001uF | 50V | B | GRM188B11H102KA01D | K22174821 | | 1- | A | A1 |
| C 3322 | CHIP CAP. | 0.001uF | 50V | B | GRM188B11H102KA01D | K22174821 | | 1- | A | A1 |
| C 3323 | CHIP CAP. | 0.01uF | 250V | X7R | GRM21BR72E103KW03L | K22240801 | | 1- | B | h2 |
| C 3324 | CHIP CAP. | 8pF | 200V | CH | GRM2192C2D8R0DY21D | K22230214 | | 1- | A | A2 |
| C 3325 | CHIP CAP. | 220pF | 50V | CH | GRM1882C1H221JA01D | K22174243 | | 1- | A | B2 |
| C 3326 | CHIP CAP. | 0.1uF | 250V | X7R | GRM32DR72E104KW01L | K22245801 | | 1- | B | h2 |
| C 3327 | CHIP CAP. | 0.1uF | 16V | B | GRM188B11C104KA01D | K22124805 | | 1- | B | g1 |
| C 3328 | CHIP CAP. | 0.01uF | 50V | B | GRM188B11H103KA01D | K22174823 | | 1- | B | g1 |
| C 3329 | CHIP CAP. | 0.01uF | 50V | B | GRM188B11H103KA01D | K22174823 | | 1- | B | g1 |
| C 3330 | CHIP CAP. | 0.001uF | 50V | B | GRM188B11H102KA01D | K22174821 | | 1- | B | g1 |
| C 3331 | CHIP CAP. | 0.1uF | 16V | B | GRM188B11C104KA01D | K22124805 | | 1- | B | e1 |
| C 3332 | CHIP CAP. | 0.01uF | 50V | B | GRM188B11H103KA01D | K22174823 | | 1- | B | e1 |
| C 3333 | CHIP CAP. | 0.001uF | 50V | B | GRM188B11H102KA01D | K22174821 | | 1- | B | e1 |
| C 3334 | CHIP CAP. | 1pF | 200V | CK | GRM2194C2D1R0CY21D | K22230208 | VER. FH | 77-78 | A | A1 |
| C 3334 | CHIP CAP. | 1pF | 200V | CK | GRM2194C2D1R0CY21D | K22230208 | | 79- | A | A1 |
| C 3338 | CHIP CAP. | 1pF | 50V | CK | GRM1884C1H1R0CZ01D | K22174202 | EXPORT | 1- | A | B1 |
| C 3338 | CHIP CAP. | 1pF | 50V | CK | GRM1884C1H1R0CZ01D | K22174202 | FRANCE | 1- | A | B1 |
| C 3339 | CHIP CAP. | 7pF | 200V | CH | GRM2192C2D7R0DY21D | K22230213 | | 1- | A | D2 |
| C 3340 | FILM CAP. | 10pF | 500V | | UC232H0100D-T | K33279019 | | 18-59 | A | F1 |
| C 3342 | CHIP CAP. | 0.001uF | 630V | R | GRM31BR32J102KY01L | K22281801 | | 60- | B | b1 |
| C 3343 | CHIP CAP. | 0.01uF | 250V | X7R | GRM21BR72E103KW03L | K22240801 | | 60- | B | b1 |
| D 3001 | DIODE | | | | BAS316 | G2070716 | | 1-5 | A | G7 |
| D 3002 | DIODE | | | | BAS316 | G2070716 | | 1- | A | G7 |
| D 3002 | DIODE | | | | UDZS TE-17 16B | G2070914 | | 6- | A | G7 |
| D 3003 | DIODE | | | | BAS316 | G2070716 | | 1- | A | D6 |
| D 3005 | DIODE | | | | DAP202K T146 | G2070180 | | 1- | A | G3 |
| D 3006 | DIODE | | | | BAS316 | G2070716 | | 1- | A | D6 |
| D 3007 | DIODE | | | | BAS316 | G2070716 | | 1- | A | C6 |
| D 3008 | DIODE | | | | UDZS TE-17 16B | G2070914 | | 1- | A | C6 |
| D 3009 | DIODE | | | | 11ES1 | G2090499 | | 1- | | |
| D 3009 | DIODE | | | | 10EDB10 | G2090781 | | 19-59 | | |
| D 3010 | DIODE | | | | DAN202K T146 | G2070182 | | 1-59 | | |
| D 3011 | DIODE | | | | DAN202K T146 | G2070182 | | 1- | A | H5 |
| D 3012 | DIODE | | | | 11ES1 | G2090499 | | 1- | A | F3 |
| D 3012 | DIODE | | | | 10EDB10 | G2090781 | | 19- | A | F3 |
| D 3013 | DIODE | | | | DAN202K T146 | G2070182 | | 1- | A | G6 |
| D 3014 | DIODE | | | | DAP236U T106 | G2070592 | | 1- | A | D4 |
| D 3015 | DIODE | | | | HSU277TRF-E | G2070118 | | 1- | B | e6 |
| D 3016 | DIODE | | | | DAP236U T106 | G2070592 | | 1- | A | D4 |
| D 3017 | DIODE | | | | DAP236U T106 | G2070592 | | 1- | B | e2 |
| D 3018 | DIODE | | | | UM9957F/TR | G2070562 | | 1- | A | D1 |
| D 3018 | DIODE | | | | XB15A709A0HR | G2070826 | | 10- | A | D1 |
| D 3018 | DIODE | | | | L709CER | G2071124 | | 64- | A | D1 |
| D 3019 | DIODE | | | | UM9957F/TR | G2070562 | | 1- | A | E2 |
| D 3019 | DIODE | | | | XB15A709A0HR | G2070826 | | 10- | A | E2 |
| D 3019 | DIODE | | | | L709CER | G2071124 | | 64- | A | E2 |
| D 3021 | DIODE | | | | UM9957F/TR | G2070562 | | 1- | A | D1 |
| D 3021 | DIODE | | | | XB15A709A0HR | G2070826 | | 10- | A | D1 |
| D 3021 | DIODE | | | | L709CER | G2071124 | | 64- | A | D1 |
| D 3022 | DIODE | | | | UM9957F/TR | G2070562 | | 1- | A | E2 |
| D 3022 | DIODE | | | | XB15A709A0HR | G2070826 | | 10- | A | E2 |
| D 3022 | DIODE | | | | L709CER | G2071124 | | 64- | A | E2 |
| D 3023 | DIODE | | | | HSU277TRF-E | G2070118 | | 1- | A | D2 |
| D 3024 | DIODE | | | | BAS316 | G2070716 | | 1- | A | C4 |
| D 3025 | DIODE | | | | BAS316 | G2070716 | | 1- | A | C5 |
| D 3026 | DIODE | | | | BAS316 | G2070716 | | 1- | B | e4 |
| D 3027 | DIODE | | | | BAS316 | G2070716 | | 1- | B | f5 |
| D 3028 | DIODE | | | | BAS316 | G2070716 | | 1- | A | C5 |
| D 3029 | DIODE | | | | BAS316 | G2070716 | | 1- | A | C3 |
| D 3030 | DIODE | | | | BAS316 | G2070716 | | 1- | B | e6 |
| D 3031 | DIODE | | | | BAS316 | G2070716 | | 1- | B | e4 |

PA Unit

Parts List

| REF | DESCRIPTION | VALUE | V/W | TOL. | MFR'S DESIG | VXSTD P/N | VERS. | LOT | SIDE | LAY ADR |
|--------|----------------|----------|-----|------|----------------------|-----------|---------|-------|------|---------|
| D 3032 | DIODE | | | | BAS316 | G2070716 | | 1- | A | C4 |
| D 3033 | DIODE | | | | BAS316 | G2070716 | | 1- | A | C3 |
| D 3034 | DIODE | | | | BAS316 | G2070716 | | 1- | B | e5 |
| D 3035 | DIODE | | | | BAS316 | G2070716 | | 1- | B | e3 |
| D 3036 | DIODE | | | | BAS316 | G2070716 | | 1- | A | D2 |
| D 3037 | DIODE | | | | BAS316 | G2070716 | | 1- | B | f2 |
| D 3038 | DIODE | | | | UM9957F/TR | G2070562 | | 1- | B | e1 |
| D 3038 | DIODE | | | | XB15A709A0HR | G2070826 | | 10- | B | e1 |
| D 3038 | DIODE | | | | L709CER | G2071124 | | 64- | B | e1 |
| D 3039 | DIODE | | | | HSU277TRF-E | G2070118 | | 1- | A | D2 |
| D 3040 | DIODE | | | | HSU277TRF-E | G2070118 | | 1- | B | e2 |
| D 3041 | DIODE | | | | UM9957F/TR | G2070562 | | 1- | A | C1 |
| D 3041 | DIODE | | | | MA4P1250 | G2070974 | | 18- | A | C1 |
| D 3041 | DIODE | | | | UM9401F/TR | G2070516 | | 25- | A | C1 |
| D 3042 | DIODE | | | | DAN202K T146 | G2070182 | | 1- | B | g2 |
| D 3043 | DIODE | | | | DAN202K T146 | G2070182 | | 1- | B | g2 |
| D 3044 | DIODE | | | | RB751S-40TE61 | G2070850 | | 1- | A | B1 |
| D 3045 | DIODE | | | | BAS316 | G2070716 | | 1- | B | h4 |
| D 3046 | DIODE | | | | BAS316 | G2070716 | | 1- | B | h5 |
| D 3047 | DIODE | | | | BAS316 | G2070716 | | 1- | B | h6 |
| D 3048 | DIODE | | | | BAS316 | G2070716 | | 1- | B | h3 |
| D 3049 | DIODE | | | | BAS316 | G2070716 | | 1- | B | h5 |
| D 3050 | DIODE | | | | MA729-(TX) | G2070320 | | 1- | A | B2 |
| D 3051 | DIODE | | | | BAS316 | G2070716 | | 1- | B | h4 |
| D 3052 | DIODE | | | | BAS316 | G2070716 | | 1- | B | g2 |
| D 3053 | DIODE | | | | DAN235U TL | G2070176 | | 1- | B | e1 |
| D 3054 | DIODE | | | | RB751S-40TE61 | G2070850 | | 1- | A | A1 |
| D 3055 | DIODE | | | | MA729-(TX) | G2070320 | | 1- | A | B2 |
| D 3056 | SURGE ABSORBER | | | | RCCA-301Q43UA | Q9000756 | | 1- | B | h2 |
| D 3057 | DIODE | | | | HSU277TRF-E | G2070118 | | 1- | B | e2 |
| D 3058 | SURGE ABSORBER | | | | RCCA-301Q43UA | Q9000756 | | 1- | B | h1 |
| D 3059 | DIODE | | | | HSU277TRF-E | G2070118 | | 1- | B | e2 |
| FB3003 | FERRITE BEADS | | | | SMB304729 | L9190094 | | 1- | A | G1 |
| FB3004 | FERRITE BEADS | | | | FB-43-801 | L9190025 | | 1- | | |
| J 3001 | CONNECTOR | | | | 24FLT-SM1-TB(LF)(SN) | P1091128 | | 1- | A | G7 |
| J 3002 | CONNECTOR | | | | SC25-02WS | P0090621 | | 1 | A | G7 |
| J 3003 | CONNECTOR | | | | B2B-ZR(LF)(SN) | P0090647 | | 1- | A | H6 |
| J 3004 | CONNECTOR | | | | B2B-ZR(LF)(SN) | P0090647 | | 1- | A | H6 |
| J 3005 | CONNECTOR | | | | B2B-EH(LF)(SN) | P0090666 | | 1- | A | B7 |
| JP3001 | WIRE ASSY | | | | RED 140 TMP/TMP(B1) | T9318198 | | 1-2 | A | G2 |
| JP3001 | WIRE ASSY | | | | RED 140 TMP/TMP(B1) | T9318201 | W/ CE | 3- | A | G2 |
| JP3001 | WIRE ASSY | | | | RED 140 TMP/TMP(B1) | T9318198 | W/O CE | 3- | A | G2 |
| JP3002 | WIRE ASSY | | | | GRN 290 TMP/TMP(B1) | T9318197 | | 1- | A | D1 |
| JP3003 | WIRE ASSY | | | | AH007M | T9207026 | | 1 | | |
| JP3003 | WIRE ASSY | | | | AH007M | T9207030 | W/ CE | 2- | | |
| JP3003 | WIRE ASSY | | | | AH007M | T9207026 | W/O CE | 2- | | |
| JP3004 | WIRE ASSY | | | | GRN 25 2/2 | T50502500 | VER. FH | 77-78 | | |
| L 3001 | COIL | | | | E2 0.25-1.9-12T-L | L0022592 | | 1- | A | H2 |
| L 3002 | COIL | | | | E2 0.25-1.9-12.5T-L | L0022600 | | 1- | A | H3 |
| L 3003 | COIL | | | | E2 0.5-2.0-6T-R | L0022488 | | 1- | A | H2 |
| L 3004 | COIL | | | | E2 0.45-1.4-4T-L | L0022391 | | 1- | A | G2 |
| L 3005 | COIL | | | | E2 0.5-2.0-7T-R | L0022489 | | 1- | A | H2 |
| L 3006 | COIL | | | | E2 0.35-1.6-4.5T-L | L0022577 | | 1- | A | G2 |
| L 3007 | COIL | | | | E2 0.3-1.7-8T-L | L0022376 | | 1- | A | H2 |
| L 3009 | COIL | | | | E2 0.3-1.7-8T-L | L0022376 | | 1- | A | H2 |
| L 3010 | COIL | | | | E2 0.4-3.0-9.5T-L | L0022575 | | 1- | A | H3 |
| L 3011 | COIL | | | | E2 0.25-1.85-8.5T-L | L0022576 | | 1- | A | H4 |
| L 3012 | COIL | | | | E2 0.3-1.7-8T-L | L0022376 | | 1- | A | H2 |
| L 3013 | M.RFC | 0.0056uH | | | HK1608 5N6S-T | L1690513 | | 1- | A | G2 |
| L 3013 | COIL | | | | E2 0.3-0.9-3T-R | L0022389 | | 60- | A | G2 |
| L 3014 | COIL | | | | E2 0.45-1.4-4T-L | L0022391 | | 1- | A | G1 |
| L 3014 | COIL | | | | E2 0.35-1.6-4T-L | L0022456 | | 60- | A | G1 |
| L 3015 | M.RFC | 10uH | | | CDRH73NP-100MC | L1690598 | | 1- | A | H4 |
| L 3016 | COIL | | | | E2 0.4-3.0-9.5T-L | L0022575 | | 1- | A | G1 |
| L 3017 | TOROIDAL COIL | 6uH | | | 6H3 TR10X5X5 | L0022831 | | 1- | A | F4 |
| L 3018 | RFC WITH BEADS | | | | 3A RI5.8X6.4-2 | L1020729 | | 1- | A | D7 |
| L 3019 | RFC WITH BEADS | | | | 3A RI5.8X6.4-2 | L1020729 | | 1- | A | E2 |
| L 3020 | COIL | 0.11uH | | | AS0810-B0NK | L0022542 | | 1- | A | E2 |
| L 3021 | M.RFC | 4.7uH | | | LK2125 4R7K-T | L1690327 | | 1- | A | D5 |
| L 3022 | COIL A1 | | | | 4.5T6.0D1.2UEW R | L0022150 | | 1- | A | D3 |
| L 3023 | M.RFC | 4.7uH | | | LK2125 4R7K-T | L1690327 | | 1- | A | D5 |
| L 3024 | M.RFC | 0.47uH | | | LK2125 R47K-T | L1690315 | | 1- | B | e4 |
| L 3025 | M.RFC | 1.8uH | | | LK2125 1R8K-T | L1690322 | | 1- | B | e5 |

PA Unit

Parts List

| REF | DESCRIPTION | VALUE | V/W | TOL. | MFR'S DESIG | VXSTD P/N | VERS. | LOT | SIDE | LAY ADR |
|--------|---------------|---------|-----|------|-------------------|-----------|-------|------|------|---------|
| L 3026 | M.RFC | 1uH | | | LK2125 1R0K-T | L1690319 | | 1- | B | e3 |
| L 3027 | M.RFC | 0.39uH | | | LK2125 R39K-T | L1690314 | | 1- | B | e3 |
| L 3029 | COIL | 0.015uH | | | AS0803-15NK | L0022536 | | 1- | A | E1 |
| L 3030 | CHIP COIL | 4.7uH | | | C2520C-4R7K | L1690735 | | 1- | A | E1 |
| L 3030 | CHIP COIL | 1uH | | 2% | C2520C-1R0G | L1691309 | | 62- | A | E1 |
| L 3031 | COIL | | | | E2 0.4-3.0-9.5T-L | L0022575 | | 1- | A | E2 |
| L 3032 | COIL | 0.047uH | | | AS0805-47NK | L0022539 | | 1- | A | D1 |
| L 3034 | COIL | 0.015uH | | | AS0803-15NK | L0022536 | | 1- | A | D2 |
| L 3035 | M.RFC | 4.7uH | | | LK2125 4R7K-T | L1690327 | | 1- | A | D5 |
| L 3036 | M.RFC | 1.8uH | | | LK2125 1R8K-T | L1690322 | | 1- | B | e5 |
| L 3037 | M.RFC | 1uH | | | LK2125 1R0K-T | L1690319 | | 1- | B | e3 |
| L 3038 | M.RFC | 0.47uH | | | LK2125 R47K-T | L1690315 | | 1- | B | e4 |
| L 3039 | M.RFC | 0.39uH | | | LK2125 R39K-T | L1690314 | | 1- | B | e3 |
| L 3040 | COIL | 0.056uH | | | AS0806-56NK | L0022540 | | 1- | A | D1 |
| L 3041 | COIL | 0.047uH | | | AS0805-47NK | L0022539 | | 1- | A | C1 |
| L 3042 | COIL | | | | E2 0.4-2.0-5.5T-L | L0022630 | | 1- | A | D1 |
| L 3043 | COIL | 0.01uH | | | AS1003-10NK | L0022544 | | 1- | A | D2 |
| L 3044 | COIL | 0.01uH | | | AS1003-10NK | L0022544 | | 1- | A | C1 |
| L 3045 | COIL | | | | E2 0.3-0.9-6T-R | L0022375 | | 1- | A | D2 |
| L 3046 | TOROIDAL COIL | 4.5uH | | | 4.50U T44-2 | L0022560 | | 1- | A | B4 |
| L 3047 | TOROIDAL COIL | 2.05uH | | | 2.05U T44-2 | L0022562 | | 1- | A | B5 |
| L 3048 | TOROIDAL COIL | 1.32uH | | | 1.32U T44-2 | L0022564A | | 1- | A | B6 |
| L 3049 | TOROIDAL COIL | 0.558uH | | | 0.558U T44-10 | L0022566A | | 1- | A | B4 |
| L 3050 | TOROIDAL COIL | 0.4uH | | | 0.400U T44-10 | L0022567 | | 1- | A | B4 |
| L 3051 | TOROIDAL COIL | 0.114uH | | | 0.114U T44-10 | L0022569 | | 1- | A | B3 |
| L 3052 | COIL B1 | | | | 6.0T8.0D0.8UEW L | L0022570 | | 1- | A | C4 |
| L 3053 | M.RFC | 0.18uH | | | LK2125 R18K-T | L1690310 | | 1- | B | e2 |
| L 3054 | M.RFC | 0.18uH | | | LK2125 R18K-T | L1690310 | | 1- | B | e2 |
| L 3055 | COIL | 0.047uH | | | AS0805-47NK | L0022539 | | 1- | A | C1 |
| L 3056 | COIL | 0.047uH | | | AS0805-47NK | L0022539 | | 1- | A | C1 |
| L 3057 | CHIP COIL | 4.7uH | | | C2520C-4R7K | L1690735 | | 1- | A | D1 |
| L 3058 | COIL | 0.01uH | | | AS1003-10NK | L0022544 | | 1- | A | C2 |
| L 3059 | TOROIDAL COIL | 3.6uH | | | 3.60U T44-2 | L0022561 | | 1- | A | B4 |
| L 3060 | TOROIDAL COIL | 1.57uH | | | 1.57U T44-2 | L0022563 | | 1- | A | B5 |
| L 3061 | TOROIDAL COIL | 1.11uH | | | 1.11U T44-2 | L0022565A | | 1- | A | B5 |
| L 3062 | TOROIDAL COIL | 0.4uH | | | 0.400U T44-10 | L0022567 | | 1- | A | B3 |
| L 3063 | COIL B1 | | | | 9.0T8.5D0.9UEW R | L0021856 | | 1- | A | C6 |
| L 3064 | TOROIDAL COIL | 0.146uH | | | 0.146U T44-10 | L0022568 | | 1- | A | B3 |
| L 3065 | COIL B1 | | | | 7.0T8.5D0.9UEW R | L0021858 | | 1- | A | A4 |
| L 3066 | TOROIDAL COIL | 0.146uH | | | 0.146U T44-10 | L0022568 | | 1- | A | B3 |
| L 3067 | COIL | 0.022uH | | | AS1004-22NK | L0022545 | | 1- | A | B1 |
| L 3068 | M.RFC | 4.7uH | | | ELJ-FC4R7KF | L1690348 | | 1- | A | B1 |
| L 3069 | COIL | 0.015uH | | | AS1203-15NK | L0022543 | | 1- | A | C1 |
| L 3070 | M.RFC | 470uH | | | FLC32T-471J | L1690235 | | 1- | A | B2 |
| L 3071 | M.RFC | 0.012uH | | | HK1608 12NJ-T | L1690517 | | 1- | B | e1 |
| L 3072 | M.RFC | 4.7uH | | | ELJ-FC4R7KF | L1690348 | | 1- | A | A1 |
| L 3073 | M.RFC | 470uH | | | FLC32T-471J | L1690235 | | 1- | A | B2 |
| L 3074 | M.RFC | 120uH | | | RCH-875 121K | L1190396 | | 1- | A | A1 |
| L 3075 | M.RFC | 22uH | | | RCR875DNP-220L | L1190397 | | 1- | A | B1 |
| Q 3001 | IC | | | | TA75S01F(TE85R.F) | G1091593 | | 1- | B | f6 |
| Q 3002 | TRANSISTOR | | | | DTC323TK T146 | G3070042 | | 1- | A | H6 |
| Q 3003 | IC | | | | BU4094BCFV-E2 | G1093527 | | 1- | A | F7 |
| Q 3003 | IC | | | | CD4094BPWR | G1093866 | | 17- | A | F7 |
| Q 3004 | TRANSISTOR | | | | 2SC4154-T11-1E | G3341548E | | 1- | B | c7 |
| Q 3006 | TRANSISTOR | | | | 2SB1143S | G3211430S | | 1- | A | E7 |
| Q 3007 | IC | | | | KIA7805API | G1093163 | | 1- | A | E7 |
| Q 3008 | TRANSISTOR | | | | 2SC4154-T11-1E | G3341548E | | 1- | B | b7 |
| Q 3009 | TRANSISTOR | | | | 2SC4154-T11-1E | G3341548E | | 1- | B | b6 |
| Q 3010 | TRANSISTOR | | | | DTC124GUA T106 | G3070184 | | 1- | A | D6 |
| Q 3011 | TRANSISTOR | | | | DTC114TK T146 | G3070073 | | 1- | A | D6 |
| Q 3012 | IC | | | | BU4094BCFV-E2 | G1093527 | | 1- | A | E6 |
| Q 3012 | IC | | | | CD4094BPWR | G1093866 | | 17- | A | E6 |
| Q 3013 | TRANSISTOR | | | | 2SA812-T2B M5B | G3108127E | | 1- | B | c6 |
| Q 3014 | TRANSISTOR | | | | 2SD1801S-TL | G3418018S | | 1- | A | H5 |
| Q 3015 | TRANSISTOR | | | | 2SD1801S-TL | G3418018S | | 1-59 | A | H5 |
| Q 3016 | TRANSISTOR | | | | DTC143ZUA T106 | G3070188 | | 1- | B | h3 |
| Q 3017 | TRANSISTOR | | | | DTC143ZUA T106 | G3070188 | | 1- | A | E6 |
| Q 3018 | TRANSISTOR | | | | DTA113ZKA T146 | G3070129 | | 1- | A | F7 |
| Q 3019 | TRANSISTOR | | | | DTA113ZKA T146 | G3070129 | | 1- | B | a6 |
| Q 3020 | TRANSISTOR | | | | IMD3 T108 | G3070053 | | 1- | A | F7 |
| Q 3021 | TRANSISTOR | | | | IMD3 T108 | G3070053 | | 1- | A | G7 |
| Q 3022 | TRANSISTOR | | | | 2SC5125-21 | G3351250 | | 1- | A | F3 |
| Q 3022 | TRANSISTOR | | | | 2SC2782 | G3327820 | | 51- | A | F3 |

PA Unit

Parts List

| REF | DESCRIPTION | VALUE | V/W | TOL. | MFR'S DESIG | VXSTD P/N | VERS. | LOT | SIDE | LAY ADR |
|--------|-------------|-------|-------|------|------------------|-----------|-------|-----|------|---------|
| Q 3023 | TRANSISTOR | | | | 2SC5125-21 | G3351250 | | 1- | A | F5 |
| Q 3023 | TRANSISTOR | | | | 2SC2782 | G3327820 | | 51- | A | F5 |
| Q 3024 | TRANSISTOR | | | | 2SC3102 | G3331020 | | 1- | A | F1 |
| Q 3024 | FET | | | | RD70HVF1-101 | G3090140 | | 60- | A | F1 |
| Q 3025 | TRANSISTOR | | | | DTC143ZUA T106 | G3070188 | | 1- | A | E6 |
| Q 3026 | TRANSISTOR | | | | DTC143ZUA T106 | G3070188 | | 1- | A | D6 |
| Q 3027 | TRANSISTOR | | | | DTA113ZKA T146 | G3070129 | | 1- | A | G6 |
| Q 3028 | TRANSISTOR | | | | 2SB624-T2B BV4 | G3206247D | | 1- | A | F6 |
| Q 3029 | TRANSISTOR | | | | 2SB624-T2B BV4 | G3206247D | | 1- | A | F6 |
| Q 3030 | TRANSISTOR | | | | DTC143ZUA T106 | G3070188 | | 1- | A | E6 |
| Q 3031 | TRANSISTOR | | | | DTC143ZUA T106 | G3070188 | | 1- | A | E6 |
| Q 3032 | TRANSISTOR | | | | DTC143ZUA T106 | G3070188 | | 1- | A | A6 |
| Q 3033 | TRANSISTOR | | | | DTC143ZUA T106 | G3070188 | | 1- | B | f5 |
| Q 3034 | TRANSISTOR | | | | 2SC5374-TL | G3353748 | | 1- | A | D2 |
| Q 3035 | TRANSISTOR | | | | IMH6A T108 | G3070066 | | 1- | B | f2 |
| Q 3036 | TRANSISTOR | | | | DTC143ZUA T106 | G3070188 | | 79- | | |
| R 3001 | CHIP RES. | 100k | 1/16W | 5% | RMC1/16 104JATP | J24185104 | | 1- | A | G7 |
| R 3002 | CHIP RES. | 47k | 1/16W | 5% | RMC1/16 473JATP | J24185473 | | 1- | A | G7 |
| R 3004 | CHIP RES. | 1k | 1/16W | 5% | RMC1/16 102JATP | J24185102 | | 1- | B | f6 |
| R 3005 | CHIP RES. | 180k | 1/10W | 0.5% | RR1220R-184-D-T5 | J24209225 | | 1- | B | f6 |
| R 3006 | CHIP RES. | 10k | 1/16W | 5% | RMC1/16 103JATP | J24185103 | | 1- | B | f6 |
| R 3007 | CHIP RES. | 1.5k | 1/10W | 0.1% | RR1220P-152-B | J24209078 | | 1- | B | f6 |
| R 3008 | CHIP RES. | 470 | 1W | 5% | RMC1 471JTE | J24305471 | | 79- | A | G2 |
| R 3009 | CHIP RES. | 0 | 1W | 5% | RMC1 JPATE | J24305000 | | 1- | A | G2 |
| R 3009 | CHIP RES. | 10 | 1W | 5% | RMC1 100JTE | J24305100 | | 79- | A | G2 |
| R 3010 | CHIP RES. | 470 | 1W | 5% | RMC1 471JTE | J24305471 | | 79- | A | H2 |
| R 3011 | CHIP RES. | 0 | 1/16W | 5% | RMC1/16 000JATP | J24185000 | | 1- | B | b7 |
| R 3012 | CHIP RES. | 22 | 1W | 5% | RMC1 220JTE | J24305220 | | 1- | B | a7 |
| R 3013 | CHIP RES. | 180k | 1/10W | 0.5% | RR1220R-184-D-T5 | J24209225 | | 1- | B | f6 |
| R 3014 | CHIP RES. | 1.5k | 1/10W | 0.1% | RR1220P-152-B | J24209078 | | 1- | B | f6 |
| R 3015 | CHIP RES. | 10k | 1/10W | 0.1% | RR1220P-103-B | J24209098 | | 1- | B | f6 |
| R 3016 | CHIP RES. | 4.7k | 1/16W | 5% | RMC1/16 472JATP | J24185472 | | 1- | B | f6 |
| R 3017 | CHIP RES. | 1.5k | 1/10W | 0.1% | RR1220P-152-B | J24209078 | | 1- | B | e6 |
| R 3018 | CHIP RES. | 1.5k | 1/10W | 0.1% | RR1220P-152-B | J24209078 | | 1- | B | e6 |
| R 3019 | CHIP RES. | 10k | 1/10W | 0.1% | RR1220P-103-B | J24209098 | | 1- | B | e6 |
| R 3020 | CHIP RES. | 0 | 1/16W | 5% | RMC1/16 000JATP | J24185000 | | 1- | A | G2 |
| R 3025 | CHIP RES. | 10k | 1/16W | 5% | RMC1/16 103JATP | J24185103 | | 1- | B | b7 |
| R 3026 | CHIP RES. | 3.9k | 1/16W | 1% | RMC1/16 392FTP | J24183392 | | 1- | B | b7 |
| R 3027 | CHIP RES. | 100 | 1/4W | 5% | RMC1/4 101JATP | J24245101 | | 1- | B | c6 |
| R 3028 | CHIP RES. | 2.2k | 1/16W | 5% | RMC1/16 222JATP | J24185222 | | 1- | B | b7 |
| R 3029 | CHIP RES. | 1k | 1/16W | 1% | RMC1/16 102FTP | J24183102 | | 1- | B | b7 |
| R 3030 | CHIP RES. | 100 | 1/4W | 5% | RMC1/4 101JATP | J24245101 | | 1- | B | b7 |
| R 3031 | CHIP RES. | 4.7k | 1/16W | 5% | RMC1/16 472JATP | J24185472 | | 1- | B | b6 |
| R 3032 | CHIP RES. | 47k | 1/16W | 5% | RMC1/16 473JATP | J24185473 | | 1- | A | G4 |
| R 3033 | CHIP RES. | 4.7k | 1/16W | 5% | RMC1/16 472JATP | J24185472 | | 1- | A | G4 |
| R 3034 | CHIP RES. | 4.7k | 1/16W | 5% | RMC1/16 472JATP | J24185472 | | 1- | A | H3 |
| R 3035 | CHIP RES. | 82k | 1/16W | 5% | RMC1/16 823JATP | J24185823 | | 1- | A | G4 |
| R 3037 | CHIP RES. | 10k | 1/16W | 5% | RMC1/16 103JATP | J24185103 | | 1- | A | D6 |
| R 3038 | CHIP RES. | 330 | 1W | 5% | RMC1 331JTE | J24305331 | | 1- | B | a4 |
| R 3039 | CHIP RES. | 1k | 1/16W | 5% | RMC1/16 102JATP | J24185102 | | 1- | A | C6 |
| R 3040 | CHIP RES. | 0 | 1/16W | 5% | RMC1/16 000JATP | J24185000 | | 1- | A | H4 |
| R 3041 | CHIP RES. | 0 | 1/16W | 5% | RMC1/16 000JATP | J24185000 | | 1- | A | G2 |
| R 3042 | CHIP RES. | 0 | 1/16W | 5% | RMC1/16 000JATP | J24185000 | | 1- | A | G1 |
| R 3043 | CHIP RES. | 1k | 1/16W | 5% | RMC1/16 102JATP | J24185102 | | 1- | B | c7 |
| R 3044 | CHIP RES. | 100 | 1/4W | 5% | RMC1/4 101JATP | J24245101 | | 1- | B | c7 |
| R 3045 | CHIP RES. | 0.33 | 1W | 10% | RMC1 R33KATE | J24309001 | | 1- | B | c7 |
| R 3046 | CHIP RES. | 2.2 | 1W | 5% | RMC1 2R2JTE | J24305229 | | 1- | A | G3 |
| R 3047 | CHIP RES. | 3.3 | 1W | 5% | RMC1 3R3JTE | J24305339 | | 1- | A | G3 |
| R 3048 | CHIP RES. | 3.9 | 1W | 5% | RMC1 3R9JTE | J24305399 | | 1- | B | b4 |
| R 3051 | CHIP RES. | 0 | 1W | 5% | RMC1 JPATE | J24305000 | | 1- | B | b3 |
| R 3052 | CHIP RES. | 330 | 1W | 5% | RMC1 331JTE | J24305331 | | 1- | B | a4 |
| R 3053 | CHIP RES. | 3.3 | 1W | 5% | RMC1 3R3JTE | J24305339 | | 1- | A | G5 |
| R 3054 | CHIP RES. | 2.2 | 1W | 5% | RMC1 2R2JTE | J24305229 | | 1- | A | G5 |
| R 3057 | CHIP RES. | 0 | 1W | 5% | RMC1 JPATE | J24305000 | | 1- | B | b5 |
| R 3060 | CHIP RES. | 100 | 1W | 5% | RMC1 101JTE | J24305101 | | 1- | B | a4 |
| R 3061 | CHIP RES. | 220 | 1/16W | 5% | RMC1/16 221JATP | J24185221 | | 1- | A | H1 |
| R 3062 | CHIP RES. | 3.9 | 1W | 5% | RMC1 3R9JTE | J24305399 | | 1- | B | b5 |
| R 3063 | CHIP RES. | 56 | 1/10W | 5% | RMC1/10T 560J | J24205560 | | 1- | B | b1 |
| R 3063 | CHIP RES. | 68 | 1W | 5% | RMC1 680JTE | J24305680 | | 60- | B | b1 |
| R 3064 | CHIP RES. | 100 | 1/16W | 5% | RMC1/16 101JATP | J24185101 | | 1- | A | H6 |
| R 3064 | CHIP RES. | 47 | 1/16W | 5% | RMC1/16 470JATP | J24185470 | | 51- | A | H6 |
| R 3065 | CHIP RES. | 10 | 1/2W | 5% | RMC1/2 100JCTP | J24275100 | | 1- | B | b3 |
| R 3066 | CHIP RES. | 10 | 1/2W | 5% | RMC1/2 100JCTP | J24275100 | | 1- | B | b6 |

PA Unit

Parts List

| REF | DESCRIPTION | VALUE | V/W | TOL. | MFR'S DESIG | VXSTD P/N | VERS. | LOT | SIDE | LAY ADR |
|--------|---------------|-------|-------|------|---------------------|-----------|-------|-----|------|---------|
| R 3067 | CHIP RES. | 2.2k | 1/16W | 5% | RMC1/16 222JATP | J24185222 | | 1- | A | F7 |
| R 3068 | CHIP RES. | 2.2k | 1/16W | 5% | RMC1/16 222JATP | J24185222 | | 1- | A | F7 |
| R 3069 | CHIP RES. | 33 | 1W | 5% | RMC1 330JTE | J24305330 | | 1- | A | E3 |
| R 3070 | CHIP RES. | 1.5k | 1/16W | 5% | RMC1/16 152JATP | J24185152 | | 1- | B | e4 |
| R 3071 | CHIP RES. | 1.5k | 1/16W | 5% | RMC1/16 152JATP | J24185152 | | 1- | B | e6 |
| R 3072 | CHIP RES. | 1.5k | 1/16W | 5% | RMC1/16 152JATP | J24185152 | | 1- | B | e4 |
| R 3073 | CHIP RES. | 1.5k | 1/16W | 5% | RMC1/16 152JATP | J24185152 | | 1- | B | e4 |
| R 3074 | CHIP RES. | 1.5k | 1/16W | 5% | RMC1/16 152JATP | J24185152 | | 1- | B | e3 |
| R 3075 | CHIP RES. | 1.5k | 1/16W | 5% | RMC1/16 152JATP | J24185152 | | 1- | B | f2 |
| R 3077 | CHIP RES. | 1k | 1/16W | 5% | RMC1/16 102JATP | J24185102 | | 1- | A | D2 |
| R 3078 | CHIP RES. | 33 | 1W | 5% | RMC1 330JTE | J24305330 | | 1- | A | E3 |
| R 3079 | CHIP RES. | 1.5k | 1/16W | 5% | RMC1/16 152JATP | J24185152 | | 1- | B | e4 |
| R 3080 | CHIP RES. | 470 | 1/16W | 5% | RMC1/16 471JATP | J24185471 | | 1- | B | e4 |
| R 3081 | CHIP RES. | 68 | 1/16W | 5% | RMC1/16 680JATP | J24185680 | | 1- | A | D2 |
| R 3082 | CHIP RES. | 470 | 1/16W | 5% | RMC1/16 471JATP | J24185471 | | 1- | A | D2 |
| R 3083 | CHIP RES. | 6.8k | 1/16W | 5% | RMC1/16 682JATP | J24185682 | | 1- | B | e2 |
| R 3084 | CHIP RES. | 33k | 1/16W | 5% | RMC1/16 333JATP | J24185333 | | 1- | B | e2 |
| R 3085 | CHIP RES. | 0 | 1/16W | 5% | RMC1/16 000JATP | J24185000 | | 1- | A | D1 |
| R 3086 | CHIP RES. | 0 | 1/16W | 5% | RMC1/16 000JATP | J24185000 | | 1- | A | D2 |
| R 3087 | CHIP RES. | 0 | 1/16W | 5% | RMC1/16 000JATP | J24185000 | | 1- | A | C1 |
| R 3088 | CHIP RES. | 0 | 1/16W | 5% | RMC1/16 000JATP | J24185000 | | 1- | B | d3 |
| R 3090 | CHIP RES. | 56 | 1W | 5% | RMC1 560JTE | J24305560 | | 1- | A | E3 |
| R 3091 | CHIP RES. | 0 | 1/16W | 5% | RMC1/16 000JATP | J24185000 | | 1- | A | C1 |
| R 3093 | CHIP RES. | 1.8k | 1/16W | 5% | RMC1/16 182JATP | J24185182 | | 1- | B | f2 |
| R 3094 | CHIP RES. | 1k | 1/16W | 5% | RMC1/16 102JATP | J24185102 | | 1- | B | f2 |
| R 3096 | CHIP RES. | 10k | 1/16W | 5% | RMC1/16 103JATP | J24185103 | | 1- | B | e2 |
| R 3097 | CHIP RES. | 10k | 1/16W | 5% | RMC1/16 103JATP | J24185103 | | 1- | B | e2 |
| R 3098 | CHIP RES. | 10k | 1/16W | 5% | RMC1/16 103JATP | J24185103 | | 1- | B | e2 |
| R 3099 | CHIP RES. | 1.5k | 1/16W | 5% | RMC1/16 152JATP | J24185152 | | 1- | B | e2 |
| R 3100 | CHIP RES. | 1k | 1/16W | 5% | RMC1/16 102JATP | J24185102 | | 1- | B | e2 |
| R 3101 | CHIP RES. | 1k | 1/16W | 5% | RMC1/16 102JATP | J24185102 | | 1- | B | e2 |
| R 3103 | CHIP RES. | 1k | 1/16W | 5% | RMC1/16 102JATP | J24185102 | | 1- | B | g1 |
| R 3104 | CHIP RES. | 100 | 1/16W | 5% | RMC1/16 101JATP | J24185101 | | 1- | A | B1 |
| R 3105 | CHIP RES. | 4.7k | 1/16W | 5% | RMC1/16 472JATP | J24185472 | | 1- | A | B2 |
| R 3106 | CHIP RES. | 56 | 1/2W | 5% | RMC1/2 560JTE | J24275560 | | 1- | B | g2 |
| R 3107 | CHIP RES. | 56 | 1/2W | 5% | RMC1/2 560JTE | J24275560 | | 1- | A | B2 |
| R 3109 | CHIP RES. | 56 | 1/2W | 5% | RMC1/2 560JTE | J24275560 | | 1- | B | g2 |
| R 3110 | CHIP RES. | 56 | 1/2W | 5% | RMC1/2 560JTE | J24275560 | | 1- | A | B2 |
| R 3112 | CHIP RES. | 27 | 1/16W | 5% | RMC1/16 270JATP | J24185270 | | 1- | A | B1 |
| R 3117 | CHIP RES. | 10k | 1/16W | 5% | RMC1/16 103JATP | J24185103 | | 1- | A | B2 |
| R 3118 | CHIP RES. | 4.7k | 1/16W | 5% | RMC1/16 472JATP | J24185472 | | 1- | A | B2 |
| R 3119 | CHIP RES. | 47k | 1/16W | 5% | RMC1/16 473JATP | J24185473 | | 1- | B | h2 |
| R 3120 | CHIP RES. | 1.5k | 1/16W | 5% | RMC1/16 152JATP | J24185152 | | 1- | B | e2 |
| R 3123 | CHIP RES. | 47k | 1/16W | 5% | RMC1/16 473JATP | J24185473 | | 1- | B | h1 |
| R 3124 | CHIP RES. | 4.7 | 1W | 5% | RMC1 4R7JTE | J24305479 | | 60- | B | b2 |
| R 3125 | CHIP RES. | 4.7 | 1W | 5% | RMC1 4R7JTE | J24305479 | | 60- | B | b2 |
| R 3126 | CHIP RES. | 68 | 1W | 5% | RMC1 680JTE | J24305680 | | 60- | B | b1 |
| R 3127 | CHIP RES. | 390 | 1/16W | 5% | RMC1/16 391JATP | J24185391 | | 60- | A | H1 |
| R 3128 | CHIP RES. | 22k | 1/16W | 5% | RMC1/16 223JATP | J24185223 | | 60- | A | G1 |
| R 3129 | CHIP RES. | 1 | 1W | 5% | RMC1 1R0JTE | J24305010 | | 60- | A | G2 |
| R 3130 | CHIP RES. | 1 | 1W | 5% | RMC1 1R0JTE | J24305010 | | 60- | A | G1 |
| R 3131 | CHIP RES. | 1 | 1W | 5% | RMC1 1R0JTE | J24305010 | | 60- | A | G1 |
| R 3132 | CHIP RES. | 10k | 1/16W | 5% | RMC1/16 103JATP | J24185103 | | 79- | | |
| RL3001 | RELAY | | DC12V | | ACP331 DC12V | M1190175 | | 1- | A | D7 |
| RL3002 | RELAY | | DC12V | | G5V-1 DC12V | M1190120 | | 1- | A | C4 |
| RL3003 | RELAY | | DC12V | | G5V-1 DC12V | M1190120 | | 1- | A | C5 |
| RL3004 | RELAY | | DC12V | | G5V-1 DC12V | M1190120 | | 1- | A | C5 |
| RL3005 | RELAY | | DC12V | | G5V-1 DC12V | M1190120 | | 1- | A | C3 |
| RL3006 | RELAY | | DC12V | | G5V-1 DC12V | M1190120 | | 1- | A | C4 |
| RL3007 | RELAY | | DC12V | | G5V-1 DC12V | M1190120 | | 1- | A | C3 |
| RL3008 | RELAY | | DC12V | | AG201344 DC12V | M1190124 | | 1- | A | C2 |
| RL3008 | RELAY | | DC12V | | AG231344 DC12V | M1190145 | | 3- | A | C2 |
| RL3009 | RELAY | | DC12V | | G5V-1 DC12V | M1190120 | | 1- | A | A4 |
| RL3010 | RELAY | | DC12V | | G5V-1 DC12V | M1190120 | | 1- | A | A5 |
| RL3011 | RELAY | | DC12V | | G5V-1 DC12V | M1190120 | | 1- | A | A6 |
| RL3012 | RELAY | | DC12V | | G5V-1 DC12V | M1190120 | | 1- | A | A3 |
| RL3013 | RELAY | | DC12V | | G5V-1 DC12V | M1190120 | | 1- | A | A5 |
| RL3014 | RELAY | | DC12V | | G5V-1 DC12V | M1190120 | | 1- | A | A4 |
| RL3015 | RELAY | | DC12V | | AG201344 DC12V | M1190124 | | 1- | A | A3 |
| RL3015 | RELAY | | DC12V | | AG231344 DC12V | M1190145 | | 3- | A | A3 |
| T 3002 | TOROIDAL COIL | | | | D12A RI16X8X8(H007) | L0022745 | | 1- | A | C7 |
| T 3003 | COIL PWR-WIDE | | | | 3A5 RIB10 | L0022791 | | 1- | A | H4 |
| T 3004 | COIL PWR-WIDE | | | | D12A RIB16X32X22 | L0022832 | | 1- | A | D4 |

PA Unit

Parts List

| REF | DESCRIPTION | VALUE | V/W | TOL. | MFR'S DESIG | VXSTD P/N | VERS. | LOT | SIDE | LAY ADR |
|--------|------------------|-------|-----|------|-----------------|-----------|-------|-------|------|---------|
| T 3005 | COIL WIDE-TRANS. | | | | 3-318707 | L0022619 | | 1- | A | D2 |
| T 3006 | COIL WIDE-TRANS. | | | | #223093 | L0022792 | | 1- | A | A2 |
| TC3001 | TRIMMER CAP. | 20pF | | | ECR-JA020E11X | K91000228 | | 1- | A | G2 |
| TC3002 | TRIMMER CAP. | 20pF | | | ECR-JA020E11X | K91000228 | | 1- | A | B2 |
| TH3001 | THERMISTOR | | | | 157-502-53002TP | G9090049 | | 1- | A | F4 |
| TH3002 | THERMISTOR | | | | 157-502-53002TP | G9090049 | | 1- | A | F2 |
| TP3025 | TERMINAL | | | | TP-E/MS-60124 | Q5000016 | | 1- | A | D5 |
| TP3026 | TERMINAL | | | | TP-E/MS-60124 | Q5000016 | | 1- | A | D5 |
| VR3001 | POT. | 470 | | | EVN-5ESX50BQ2 | J51811471 | | 1- | A | H6 |
| VR3002 | POT. | 470 | | | EVN-5ESX50BQ2 | J51811471 | | 1- | A | H1 |
| VR3003 | POT. | 220 | | | EVN-5ESX50BE2 | J51811221 | | 1- | A | B1 |
| | LEAF SPRING | | | | | R0132100 | W/ CE | 3- | | |
| | LEAF SPRING | | | | | R0132100 | | 60-63 | | |
| | LEAF SPRING | | | | | R0132100 | | 64- | | |
| | GROUND PLATE | | | | | RA0415200 | | 64- | | |
| | GROUND PLATE | | | | | RA0415200 | | 64- | | |

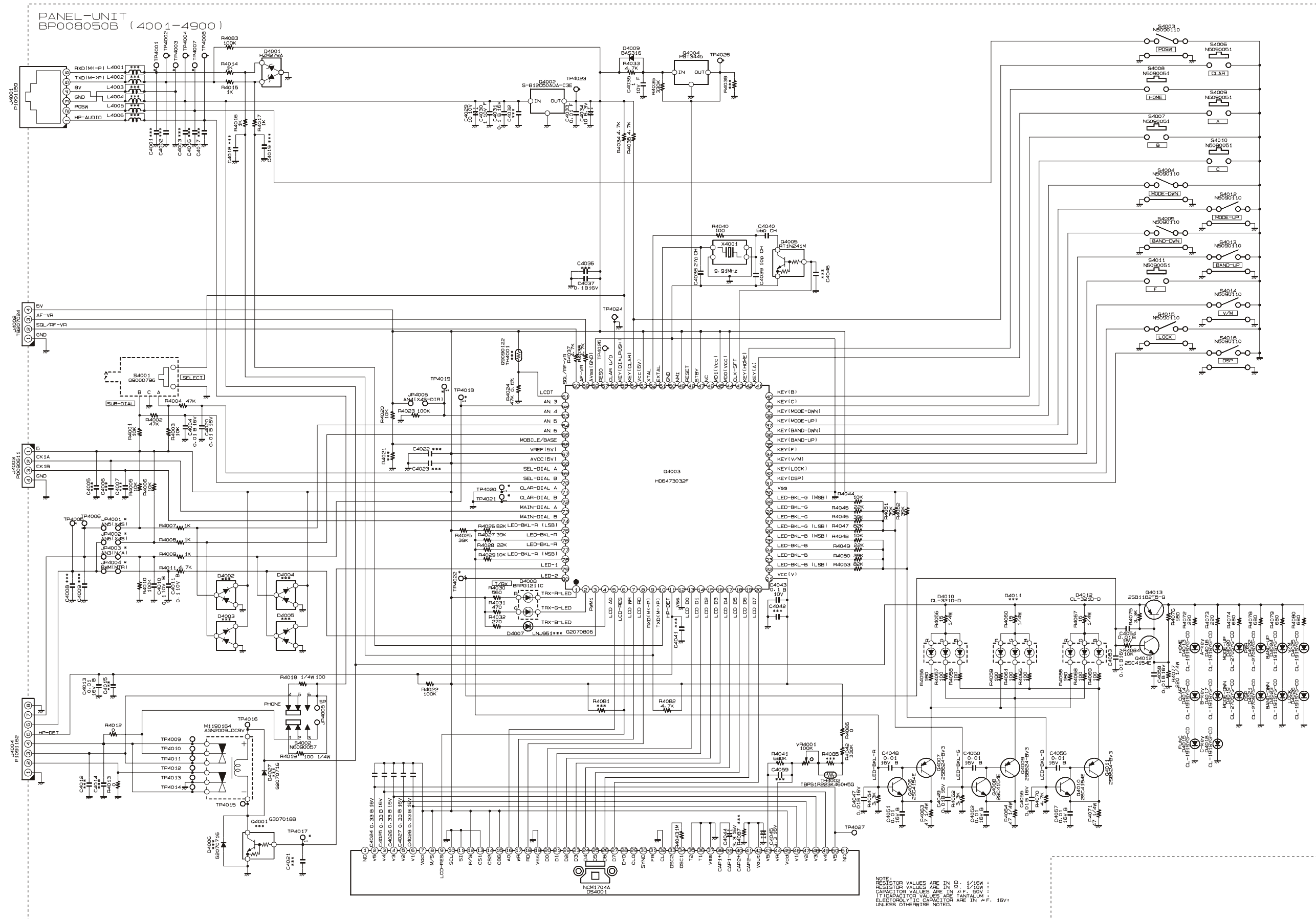

PANEL Unit

Parts List

| REF | DESCRIPTION | VALUE | V/W | TOL. | MFR'S DESIG | VXSTD P/N | VERS. | LOT | SIDE | LAY ADR | |
|-----------------------|--------------|--------|------|------|------------------------|-----------|-----------|-----|------|---------|--|
| PCB with Components | | | | | | CB1231001 | | | | | |
| Printed Circuit Board | | | | | | AH007M000 | FR0098400 | | 1- | | |
| C 4001 | CHIP CAP. | 470pF | 50V | B | GRM155B11H471KA01D | K22178805 | | 1- | B | e1 | |
| C 4002 | CHIP CAP. | 470pF | 50V | B | GRM155B11H471KA01D | K22178805 | | 1- | B | e1 | |
| C 4003 | CHIP CAP. | 470pF | 50V | B | GRM155B11H471KA01D | K22178805 | | 1- | B | e1 | |
| C 4004 | CHIP CAP. | 0.01uF | 16V | B | GRM36B103K16PT | K22128804 | | 1- | B | g2 | |
| C 4010 | CHIP CAP. | 0.1uF | 10V | B | GRM155B11A104KA01D | K22108802 | | 1- | B | b2 | |
| C 4011 | CHIP CAP. | 0.1uF | 10V | B | GRM155B11A104KA01D | K22108802 | | 1- | B | b2 | |
| C 4013 | CHIP CAP. | 0.01uF | 16V | B | GRM36B103K16PT | K22128804 | | 1- | A | G2 | |
| C 4016 | CHIP CAP. | 470pF | 50V | B | GRM155B11H471KA01D | K22178805 | | 1- | B | e1 | |
| C 4017 | CHIP CAP. | 470pF | 50V | B | GRM155B11H471KA01D | K22178805 | | 1- | B | f1 | |
| C 4020 | CHIP CAP. | 0.01uF | 16V | B | GRM36B103K16PT | K22128804 | | 1- | B | g2 | |
| C 4024 | CHIP CAP. | 0.33uF | 16V | B | GRM40B334K16PT | K22120807 | | 1- | B | e2 | |
| C 4025 | CHIP CAP. | 0.33uF | 16V | B | GRM40B334K16PT | K22120807 | | 1- | B | e2 | |
| C 4026 | CHIP CAP. | 0.33uF | 16V | B | GRM40B334K16PT | K22120807 | | 1- | B | e2 | |
| C 4027 | CHIP CAP. | 0.33uF | 16V | B | GRM40B334K16PT | K22120807 | | 1- | B | e2 | |
| C 4028 | CHIP CAP. | 0.33uF | 16V | B | GRM40B334K16PT | K22120807 | | 1- | B | e2 | |
| C 4029 | CHIP TA.CAP. | 10uF | 10V | | TEMSVA1A106M-8R | K78100028 | | 1- | B | e1 | |
| C 4030 | CHIP CAP. | 1uF | 10V | F | GRM188F11A105ZA01D | K22105001 | | 1- | B | e1 | |
| C 4031 | CHIP CAP. | 0.1uF | 16V | B | GRM188B11C104KA01D | K22124805 | | 1- | B | e1 | |
| C 4033 | CHIP CAP. | 0.01uF | 50V | F | UMK105F103ZW-F | K22179017 | | 1- | B | f1 | |
| C 4034 | CHIP TA.CAP. | 10uF | 6.3V | | TEMSVA0J106M-8R | K78080027 | | 1- | B | f2 | |
| C 4035 | CHIP CAP. | 1uF | 10V | F | GRM188F11A105ZA01D | K22105001 | | 1- | B | f2 | |
| C 4037 | CHIP CAP. | 0.1uF | 16V | B | GRM188B11C104KA01D | K22124805 | | 1- | B | e1 | |
| C 4038 | CHIP CAP. | 27pF | 50V | CH | UMK105CH270JV-F | K22178268 | | 1- | B | e1 | |
| C 4039 | CHIP CAP. | 10pF | 50V | CH | UMK105CH100DV-F | K22178258 | | 1- | B | e1 | |
| C 4040 | CHIP CAP. | 56pF | 50V | CH | UMK105CH560JV-F | K22178276 | | 1- | B | e1 | |
| C 4043 | CHIP CAP. | 0.1uF | 10V | B | GRM155B11A104KA01D | K22108802 | | 1- | B | d2 | |
| C 4044 | CHIP TA.CAP. | 3.3uF | 16V | | TESVB21C335M8R | K78120010 | | 1- | B | e2 | |
| C 4045 | CHIP TA.CAP. | 3.3uF | 16V | | TESVB21C335M8R | K78120010 | | 1- | B | e2 | |
| C 4047 | CHIP CAP. | 0.01uF | 16V | B | GRM36B103K16PT | K22128804 | | 1- | B | c1 | |
| C 4048 | CHIP CAP. | 0.01uF | 16V | B | GRM36B103K16PT | K22128804 | | 1- | B | c1 | |
| C 4049 | CHIP CAP. | 0.01uF | 16V | B | GRM36B103K16PT | K22128804 | | 1- | B | c1 | |
| C 4050 | CHIP CAP. | 0.01uF | 16V | B | GRM36B103K16PT | K22128804 | | 1- | B | c1 | |
| C 4051 | CHIP CAP. | 0.01uF | 16V | B | GRM36B103K16PT | K22128804 | | 1- | B | c1 | |
| C 4052 | CHIP CAP. | 0.01uF | 16V | B | GRM36B103K16PT | K22128804 | | 1- | B | c1 | |
| C 4053 | CHIP CAP. | 0.01uF | 16V | B | GRM36B103K16PT | K22128804 | | 1- | B | f2 | |
| C 4054 | CHIP CAP. | 0.01uF | 16V | B | GRM36B103K16PT | K22128804 | | 1- | B | f2 | |
| C 4055 | CHIP CAP. | 0.01uF | 16V | B | GRM36B103K16PT | K22128804 | | 1- | B | c2 | |
| C 4056 | CHIP CAP. | 0.01uF | 16V | B | GRM36B103K16PT | K22128804 | | 1- | B | c2 | |
| C 4057 | CHIP CAP. | 0.01uF | 16V | B | GRM36B103K16PT | K22128804 | | 1- | B | c2 | |
| C 4058 | CHIP CAP. | 0.01uF | 16V | B | GRM36B103K16PT | K22128804 | | 1- | B | g1 | |
| D 4001 | DIODE | | | | HZM27WA TR-E | G2070530 | | 1- | B | e1 | |
| D 4007 | LED | | | | LNJ951C4BRA | G2070806 | | 1- | A | F1 | |
| D 4008 | LED | | | | BRPG1211C-TR | G2070654 | | 1- | A | F1 | |
| D 4009 | DIODE | | | | BAS316 | G2070716 | | 1- | B | f2 | |
| D 4010 | LED | | | | CL-321D-D-T | G2070904 | | 1- | A | F1 | |
| D 4010 | LED | | | | CL-321G-D-T | G2071008 | | 19- | A | F1 | |
| D 4012 | LED | | | | CL-321D-D-T | G2070904 | | 1- | A | F2 | |
| D 4012 | LED | | | | CL-321G-D-T | G2071008 | | 19- | A | F2 | |
| D 4013 | LED | | | | 19-215UYOC/S530-A2/TR8 | G2070884 | | 1- | A | B1 | |
| D 4013 | LED | | | | 19-215UYOC/S530-A2/TR8 | G2070884 | | 4- | A | B1 | |
| D 4013 | LED | | | | 19-213/S2C-AN1P2B/3T | G2071096 | | 46- | A | B1 | |
| D 4014 | LED | | | | 19-215UYOC/S530-A2/TR8 | G2070884 | | 1- | A | B2 | |
| D 4014 | LED | | | | 19-215UYOC/S530-A2/TR8 | G2070884 | | 4- | A | B2 | |
| D 4014 | LED | | | | 19-213/S2C-AN1P2B/3T | G2071096 | | 46- | A | B2 | |
| D 4015 | LED | | | | 19-215UYOC/S530-A2/TR8 | G2070884 | | 1- | A | B2 | |
| D 4015 | LED | | | | 19-215UYOC/S530-A2/TR8 | G2070884 | | 4- | A | B2 | |
| D 4015 | LED | | | | 19-213/S2C-AN1P2B/3T | G2071096 | | 46- | A | B2 | |
| D 4016 | LED | | | | 19-215UYOC/S530-A2/TR8 | G2070884 | | 1- | A | C2 | |
| D 4016 | LED | | | | 19-215UYOC/S530-A2/TR8 | G2070884 | | 4- | A | C2 | |
| D 4016 | LED | | | | 19-213/S2C-AN1P2B/3T | G2071096 | | 46- | A | C2 | |
| D 4017 | LED | | | | 19-215UYOC/S530-A2/TR8 | G2070884 | | 1- | A | D2 | |
| D 4017 | LED | | | | 19-215UYOC/S530-A2/TR8 | G2070884 | | 4- | A | D2 | |
| D 4017 | LED | | | | 19-213/S2C-AN1P2B/3T | G2071096 | | 46- | A | D2 | |
| D 4018 | LED | | | | 19-215UYOC/S530-A2/TR8 | G2070884 | | 1- | A | E2 | |
| D 4018 | LED | | | | 19-215UYOC/S530-A2/TR8 | G2070884 | | 4- | A | E2 | |
| D 4018 | LED | | | | 19-213/S2C-AN1P2B/3T | G2071096 | | 46- | A | E2 | |
| D 4019 | LED | | | | CL-270TD-C-TS | G2070930 | | 1- | A | C1 | |
| D 4019 | LED | | | | CL-270TD-C-TS | G2070930 | | 4- | A | C1 | |
| D 4020 | LED | | | | CL-270TD-C-TS | G2070930 | | 1- | A | C1 | |
| D 4020 | LED | | | | CL-270TD-C-TS | G2070930 | | 4- | A | C1 | |
| D 4021 | LED | | | | CL-270TD-C-TS | G2070930 | | 1- | A | D1 | |

PANEL Unit

Parts List

| REF | DESCRIPTION | VALUE | V/W | TOL. | MFR'S DESIG | VXSTD P/N | VERS. | LOT | SIDE | LAY ADR |
|--------|-------------|-------|-------|------|------------------------|-----------|-------|-----|------|---------|
| D 4021 | LED | | | | CL-270TD-C-TS | G2070930 | | 4- | A | D1 |
| D 4022 | LED | | | | CL-270TD-C-TS | G2070930 | | 1- | A | E1 |
| D 4022 | LED | | | | CL-270TD-C-TS | G2070930 | | 4- | A | E1 |
| D 4023 | LED | | | | 19-215UYOC/S530-A2/TR8 | G2070884 | | 1- | A | G1 |
| D 4023 | LED | | | | 19-215UYOC/S530-A2/TR8 | G2070884 | | 4- | A | G1 |
| D 4023 | LED | | | | 19-213/S2C-AN1P2B/3T | G2071096 | | 46- | A | G1 |
| D 4024 | LED | | | | 19-215UYOC/S530-A2/TR8 | G2070884 | | 1- | A | G1 |
| D 4024 | LED | | | | 19-215UYOC/S530-A2/TR8 | G2070884 | | 4- | A | G1 |
| D 4024 | LED | | | | 19-213/S2C-AN1P2B/3T | G2071096 | | 46- | A | G1 |
| D 4025 | LED | | | | 19-215UYOC/S530-A2/TR8 | G2070884 | | 1- | A | H1 |
| D 4025 | LED | | | | 19-215UYOC/S530-A2/TR8 | G2070884 | | 4- | A | H1 |
| D 4025 | LED | | | | 19-213/S2C-AN1P2B/3T | G2071096 | | 46- | A | H1 |
| D 4026 | LED | | | | 19-215UYOC/S530-A2/TR8 | G2070884 | | 1- | A | H2 |
| D 4026 | LED | | | | 19-215UYOC/S530-A2/TR8 | G2070884 | | 4- | A | H2 |
| D 4026 | LED | | | | 19-213/S2C-AN1P2B/3T | G2071096 | | 46- | A | H2 |
| DS4001 | LCD MODULE | | | | NCM1704A | Q7000428 | | 1- | A | D1 |
| J 4001 | CONNECTOR | | | | HJC0271-011023 | P1091159 | | 1- | B | f1 |
| J 4002 | WIRE ASSY | | | | AH007M | T9207024 | | 1- | B | g1 |
| J 4003 | CONNECTOR | | | | SB20-04WS | P0090611 | | 1- | B | b1 |
| J 4004 | CONNECTOR | | | | 52745-0896 | P1091162 | | 1- | B | b2 |
| JP4003 | CHIP RES. | 0 | 1/16W | 5% | RMC1/16S JPTH | J24189070 | | 1- | B | b2 |
| JP4004 | CHIP RES. | 0 | 1/16W | 5% | RMC1/16S JPTH | J24189070 | | 1- | B | b2 |
| L 4001 | M.RFC | 10uH | | | LK1608 100K-T | L1690689 | | 1- | B | f1 |
| L 4002 | M.RFC | 10uH | | | LK1608 100K-T | L1690689 | | 1- | B | f1 |
| Q 4002 | IC | | | | S-812C50AUA-C3E-T2G | G1093652 | | 1- | B | f1 |
| Q 4003 | IC | | | | HD6473032F(NO PROG.) | G1093506 | | 1 | B | d2 |
| Q 4003 | IC | | | | HD6473032F R0717 | G1093818 | | 2- | B | d2 |
| Q 4003 | IC | | | | HD6433032ST09F | G1093882 | | 7- | B | d2 |
| Q 4004 | IC | | | | PST3445UR | G1093232 | | 1- | B | f2 |
| Q 4005 | TRANSISTOR | | | | RT1N241M-T11-1 | G3070249 | | 1- | B | e1 |
| Q 4006 | TRANSISTOR | | | | 2SC4154-T11-1E | G3341548E | | 1- | B | c1 |
| Q 4007 | TRANSISTOR | | | | 2SB624-T2B BV3 | G3206247C | | 1- | B | c1 |
| Q 4008 | TRANSISTOR | | | | 2SC4154-T11-1E | G3341548E | | 1- | B | c2 |
| Q 4009 | TRANSISTOR | | | | 2SB624-T2B BV3 | G3206247C | | 1- | B | c1 |
| Q 4010 | TRANSISTOR | | | | 2SC4154-T11-1E | G3341548E | | 1- | B | c2 |
| Q 4011 | TRANSISTOR | | | | 2SB624-T2B BV3 | G3206247C | | 1- | B | c2 |
| Q 4012 | TRANSISTOR | | | | 2SC4154-T11-1E | G3341548E | | 1- | B | f1 |
| Q 4013 | TRANSISTOR | | | | 2SB1182-TLQ | G3070063 | | 1- | B | f2 |
| R 4001 | CHIP RES. | 10k | 1/16W | 5% | RMC1/16S 103JTH | J24189037 | | 1- | B | g2 |
| R 4002 | CHIP RES. | 47k | 1/16W | 5% | RMC1/16S 473JTH | J24189045 | | 1- | B | g2 |
| R 4003 | CHIP RES. | 10k | 1/16W | 5% | RMC1/16S 103JTH | J24189037 | | 1- | B | g2 |
| R 4004 | CHIP RES. | 47k | 1/16W | 5% | RMC1/16S 473JTH | J24189045 | | 1- | B | g2 |
| R 4005 | CHIP RES. | 10k | 1/16W | 5% | RMC1/16S 103JTH | J24189037 | | 1- | B | c2 |
| R 4006 | CHIP RES. | 10k | 1/16W | 5% | RMC1/16S 103JTH | J24189037 | | 1- | B | c2 |
| R 4007 | CHIP RES. | 1k | 1/16W | 5% | RMC1/16S 102JTH | J24189025 | | 1- | B | c2 |
| R 4008 | CHIP RES. | 1k | 1/16W | 5% | RMC1/16S 102JTH | J24189025 | | 1- | B | c2 |
| R 4009 | CHIP RES. | 1k | 1/16W | 5% | RMC1/16S 102JTH | J24189025 | | 1- | B | c2 |
| R 4010 | CHIP RES. | 100k | 1/16W | 5% | RMC1/16S 104JTH | J24189049 | | 1- | B | c2 |
| R 4011 | CHIP RES. | 4.7k | 1/16W | 5% | RMC1/16S 472JTH | J24189033 | | 1- | B | c2 |
| R 4012 | CHIP RES. | 0 | 1/16W | 5% | RMC1/16 000JATP | J24185000 | | 1- | B | a2 |
| R 4013 | CHIP RES. | 0 | 1/16W | 5% | RMC1/16 000JATP | J24185000 | | 1- | B | a2 |
| R 4014 | CHIP RES. | 1k | 1/16W | 5% | RMC1/16S 102JTH | J24189025 | | 1- | B | e1 |
| R 4015 | CHIP RES. | 1k | 1/16W | 5% | RMC1/16S 102JTH | J24189025 | | 1- | B | e1 |
| R 4016 | CHIP RES. | 1k | 1/16W | 5% | RMC1/16S 102JTH | J24189025 | | 1- | B | e1 |
| R 4017 | CHIP RES. | 1k | 1/16W | 5% | RMC1/16S 102JTH | J24189025 | | 1- | B | e1 |
| R 4018 | CHIP RES. | 100 | 1/4W | 5% | RMC1/4 101JATP | J24245101 | | 1- | B | a1 |
| R 4019 | CHIP RES. | 100 | 1/4W | 5% | RMC1/4 101JATP | J24245101 | | 1- | A | G1 |
| R 4020 | CHIP RES. | 10k | 1/16W | 5% | RMC1/16S 103JTH | J24189037 | | 1- | B | d1 |
| R 4022 | CHIP RES. | 100k | 1/16W | 5% | RMC1/16S 104JTH | J24189049 | | 1- | B | d2 |
| R 4023 | CHIP RES. | 100k | 1/16W | 5% | RMC1/16S 104JTH | J24189049 | | 1- | B | d1 |
| R 4024 | CHIP RES. | 47k | 1/16W | 0.5% | RR0510R-473-D | J24189159 | | 1- | B | d1 |
| R 4025 | CHIP RES. | 39k | 1/16W | 5% | RMC1/16S 393JTH | J24189044 | | 1- | B | d1 |
| R 4026 | CHIP RES. | 82k | 1/16W | 5% | RMC1/16S 823JTH | J24189048 | | 1- | B | d1 |
| R 4027 | CHIP RES. | 39k | 1/16W | 5% | RMC1/16S 393JTH | J24189044 | | 1- | B | d1 |
| R 4028 | CHIP RES. | 22k | 1/16W | 5% | RMC1/16S 223JTH | J24189041 | | 1- | B | d1 |
| R 4029 | CHIP RES. | 10k | 1/16W | 5% | RMC1/16S 103JTH | J24189037 | | 1- | B | d1 |
| R 4030 | CHIP RES. | 560 | 1/10W | 5% | RMC1/10T 561J | J24205561 | | 1- | B | c1 |
| R 4031 | CHIP RES. | 470 | 1/10W | 5% | RMC1/10T 471J | J24205471 | | 1- | B | b1 |
| R 4032 | CHIP RES. | 270 | 1/10W | 5% | RMC1/10T 271J | J24205271 | | 1- | B | b1 |
| R 4033 | CHIP RES. | 4.7k | 1/16W | 5% | RMC1/16S 472JTH | J24189033 | | 1- | B | f2 |
| R 4034 | CHIP RES. | 4.7k | 1/16W | 5% | RMC1/16S 472JTH | J24189033 | | 1- | B | g2 |
| R 4035 | CHIP RES. | 4.7k | 1/16W | 5% | RMC1/16S 472JTH | J24189033 | | 1- | B | f2 |
| R 4036 | CHIP RES. | 330k | 1/16W | 5% | RMC1/16S 334JTH | J24189055 | | 1- | B | e2 |

PANEL Unit

Parts List

| REF | DESCRIPTION | VALUE | V/W | TOL. | MFR'S DESIG | VXSTD P/N | VERS. | LOT | SIDE | LAY ADR |
|--------|-----------------|---------|-------|------|------------------|-----------|-------|-----|------|---------|
| R 4037 | CHIP RES. | 4.7k | 1/16W | 5% | RMC1/16S 472JTH | J24189033 | | 1- | B | d1 |
| R 4038 | CHIP RES. | 4.7k | 1/16W | 5% | RMC1/16S 472JTH | J24189033 | | 1- | B | d1 |
| R 4040 | CHIP RES. | 100 | 1/16W | 5% | RMC1/16S 101JTH | J24189013 | | 1- | B | e1 |
| R 4041 | CHIP RES. | 680k | 1/16W | 5% | RMC1/16S 684JTH | J24189059 | | 1- | A | C2 |
| R 4041 | CHIP RES. | 560k | 1/16W | 0.5% | MCR01MZPD5603 | J24189335 | | 26- | A | C2 |
| R 4042 | CHIP RES. | 330k | 1/16W | 5% | RMC1/16S 334JTH | J24189055 | | 1- | B | e2 |
| R 4042 | CHIP RES. | 220k | 1/16W | 0.5% | MCR01MZPD2203 | J24189389 | | 26- | B | e2 |
| R 4043 | CHIP RES. | 1M | 1/16W | 5% | RMC1/16S 105JTH | J24189061 | | 1- | A | D2 |
| R 4044 | CHIP RES. | 10k | 1/16W | 5% | RMC1/16S 103JTH | J24189037 | | 1- | B | d2 |
| R 4045 | CHIP RES. | 22k | 1/16W | 5% | RMC1/16S 223JTH | J24189041 | | 1- | B | d2 |
| R 4046 | CHIP RES. | 39k | 1/16W | 5% | RMC1/16S 393JTH | J24189044 | | 1- | B | d2 |
| R 4047 | CHIP RES. | 82k | 1/16W | 5% | RMC1/16S 823JTH | J24189048 | | 1- | B | d2 |
| R 4048 | CHIP RES. | 10k | 1/16W | 5% | RMC1/16S 103JTH | J24189037 | | 1- | B | d2 |
| R 4049 | CHIP RES. | 22k | 1/16W | 5% | RMC1/16S 223JTH | J24189041 | | 1- | B | d2 |
| R 4050 | CHIP RES. | 39k | 1/16W | 5% | RMC1/16S 393JTH | J24189044 | | 1- | B | d2 |
| R 4051 | CHIP RES. | 39k | 1/16W | 5% | RMC1/16S 393JTH | J24189044 | | 1- | B | d2 |
| R 4052 | CHIP RES. | 39k | 1/16W | 5% | RMC1/16S 393JTH | J24189044 | | 1- | B | d2 |
| R 4053 | CHIP RES. | 82k | 1/16W | 5% | RMC1/16S 823JTH | J24189048 | | 1- | B | d2 |
| R 4054 | CHIP RES. | 3.3k | 1/10W | 5% | RMC1/10T 332J | J24205332 | | 1- | B | c1 |
| R 4055 | CHIP RES. | 180 | 1/10W | 5% | RMC1/10T 181J | J24205181 | | 1- | B | c1 |
| R 4056 | CHIP RES. | 15 | 1/4W | 5% | RMC1/4 150JATP | J24245150 | | 1- | B | b1 |
| R 4057 | CHIP RES. | 100 | 1/10W | 5% | RMC1/10T 101J | J24205101 | | 1- | B | c1 |
| R 4058 | CHIP RES. | 100 | 1/10W | 5% | RMC1/10T 101J | J24205101 | | 1- | B | b1 |
| R 4059 | CHIP RES. | 180 | 1/10W | 5% | RMC1/10T 181J | J24205181 | | 1- | B | c1 |
| R 4060 | CHIP RES. | 15 | 1/4W | 5% | RMC1/4 150JATP | J24245150 | | 1- | B | b1 |
| R 4061 | CHIP RES. | 100 | 1/10W | 5% | RMC1/10T 101J | J24205101 | | 1- | B | c1 |
| R 4062 | CHIP RES. | 3.3k | 1/10W | 5% | RMC1/10T 332J | J24205332 | | 1- | B | c1 |
| R 4063 | CHIP RES. | 47 | 1/4W | 5% | RMC1/4 470JATP | J24245470 | | 1- | B | c1 |
| R 4064 | CHIP RES. | 47 | 1/4W | 5% | RMC1/4 470JATP | J24245470 | | 1- | B | c1 |
| R 4065 | CHIP RES. | 100 | 1/10W | 5% | RMC1/10T 101J | J24205101 | | 1- | B | b1 |
| R 4066 | CHIP RES. | 180 | 1/10W | 5% | RMC1/10T 181J | J24205181 | | 1- | B | c2 |
| R 4067 | CHIP RES. | 15 | 1/4W | 5% | RMC1/4 150JATP | J24245150 | | 1- | B | b2 |
| R 4068 | CHIP RES. | 100 | 1/10W | 5% | RMC1/10T 101J | J24205101 | | 1- | B | c2 |
| R 4069 | CHIP RES. | 100 | 1/10W | 5% | RMC1/10T 101J | J24205101 | | 1- | B | b2 |
| R 4070 | CHIP RES. | 4.7k | 1/10W | 5% | RMC1/10T 472J | J24205472 | | 1- | B | c2 |
| R 4071 | CHIP RES. | 47 | 1/4W | 5% | RMC1/4 470JATP | J24245470 | | 1- | B | c2 |
| R 4072 | CHIP RES. | 680 | 1/10W | 5% | RMC1/10T 681J | J24205681 | | 1- | B | f1 |
| R 4073 | CHIP RES. | 680 | 1/10W | 5% | RMC1/10T 681J | J24205681 | | 1- | B | f2 |
| R 4074 | CHIP RES. | 1.2k | 1/10W | 5% | RMC1/10T 122J | J24205122 | | 1- | B | e1 |
| R 4075 | CHIP RES. | 3.3k | 1/16W | 5% | RMC1/16S 332JTH | J24189031 | | 1- | B | f1 |
| R 4076 | CHIP RES. | 180 | 1/16W | 5% | RMC1/16S 181JTH | J24189016 | | 1- | B | f1 |
| R 4077 | CHIP RES. | 220 | 1/4W | 5% | RMC1/4 221JATP | J24245221 | | 1- | B | g2 |
| R 4078 | CHIP RES. | 1.2k | 1/10W | 5% | RMC1/10T 122J | J24205122 | | 1- | B | c1 |
| R 4079 | CHIP RES. | 1.2k | 1/10W | 5% | RMC1/10T 122J | J24205122 | | 1- | B | a1 |
| R 4080 | CHIP RES. | 1.2k | 1/10W | 5% | RMC1/10T 122J | J24205122 | | 1- | B | a1 |
| R 4082 | CHIP RES. | 4.7k | 1/16W | 5% | RMC1/16S 472JTH | J24189033 | | 1- | B | d2 |
| R 4083 | CHIP RES. | 100k | 1/16W | 5% | RMC1/16S 104JTH | J24189049 | | 1- | B | e1 |
| R 4084 | CHIP RES. | 10k | 1/16W | 5% | RMC1/16S 103JTH | J24189037 | | 1- | B | g2 |
| R 4086 | CHIP RES. | 33k | 1/16W | 5% | RMC1/16S 333JTH | J24189043 | | 1- | B | e2 |
| S 4001 | ROTARY ENCODER | | | | EC12E24244A4 | Q9000796 | | 1- | A | A2 |
| S 4002 | SLIDE SWITCH | | | | SSSS22 | N6090057 | | 1- | B | a1 |
| S 4003 | TACT SWITCH | | | | SKQTLA | N5090110 | | 1- | A | E1 |
| S 4004 | TACT SWITCH | | | | SKQTLA | N5090110 | | 1- | A | C1 |
| S 4005 | TACT SWITCH | | | | SKQTLA | N5090110 | | 1- | A | G1 |
| S 4006 | TACT SWITCH | | | | SKQDAA | N5090051 | | 1- | A | B1 |
| S 4007 | TACT SWITCH | | | | SKQDAA | N5090051 | | 1- | A | D2 |
| S 4008 | TACT SWITCH | | | | SKQDAA | N5090051 | | 1- | A | B1 |
| S 4009 | TACT SWITCH | | | | SKQDAA | N5090051 | | 1- | A | C2 |
| S 4010 | TACT SWITCH | | | | SKQDAA | N5090051 | | 1- | A | E2 |
| S 4011 | TACT SWITCH | | | | SKQDAA | N5090051 | | 1- | A | B2 |
| S 4012 | TACT SWITCH | | | | SKQTLA | N5090110 | | 1- | A | D1 |
| S 4013 | TACT SWITCH | | | | SKQTLA | N5090110 | | 1- | A | G1 |
| S 4014 | TACT SWITCH | | | | SKQTLA | N5090110 | | 1- | A | H1 |
| S 4015 | TACT SWITCH | | | | SKQTLA | N5090110 | | 1- | A | H2 |
| S 4016 | TACT SWITCH | | | | SKQTLA | N5090110 | | 1- | A | D1 |
| S 4017 | ROTARY ENCODER | | | | RES20D50-201-1G | Q9000709A | | 1- | | |
| TH4002 | THERMISTOR | | | | TBPS1R223K460H5Q | G9090085 | | 1- | B | e2 |
| VR4001 | POT. | 100k | | | EVN-5ESX50B15 | J51811104 | | 1- | B | e2 |
| X 4001 | XTAL TSS-7050A | 9.91MHZ | | | 9.91MHZ | H0103276 | | 1- | B | e1 |
| | LIGHT GUIDE | | | | (LCD) | RA0451000 | | 1- | | |
| | LCD HOLDER | | | | | RA0450900 | | 1- | | |
| | REFLECTOR SHEET | | | | | RA0452400 | | 1- | | |
| | DIFFUSER SHEET | | | | | RA0452500 | | 1- | | |

PANEL Unit

Parts List

| REF | DESCRIPTION | VALUE | V/W | TOL. | MFR'S DESIG | VXSTD P/N | VERS. | LOT | SIDE | LAY ADR |
|-----|---------------|-------|-----|------|-------------|-----------|-------|-----|------|---------|
| | SHEET | | | | (LCD) | RA0481000 | | 1- | | |
| | SPACER | | | | (LCD) | RA0481900 | | 1- | | |
| | SPONGE RUBBER | | | | (TX) | RA0484900 | | 1- | | |
| | LIGHT SHEET | | | | (A) | RA0485300 | | 1- | | |
| | LIGHT SHEET | | | | (B) | RA0485400 | | 1- | | |
| | SHIELD SHEET | | | | (DSP) | RA0460300 | | 3- | | |

REF Unit

Circuit Diagram

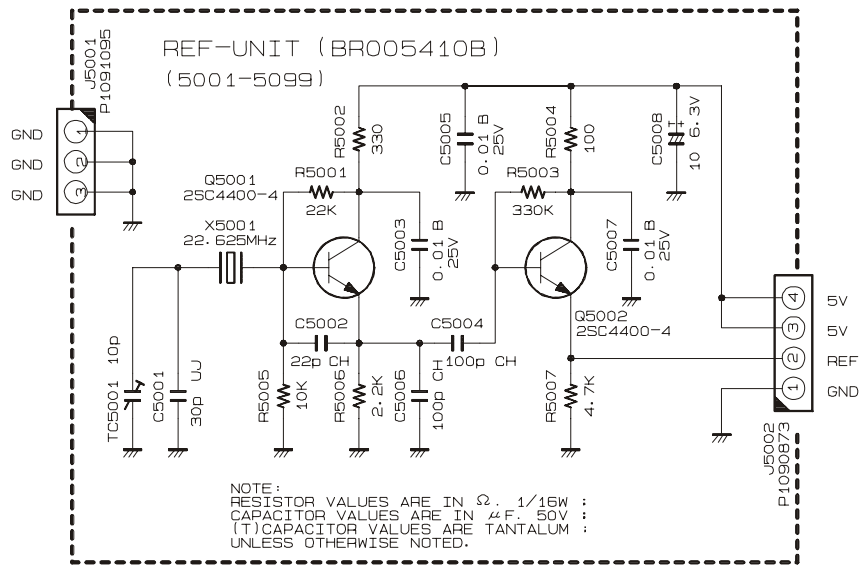

Parts Layout

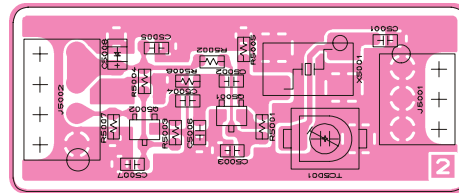
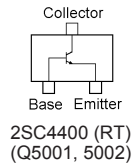

Side A



Side B

Parts List

| REF | DESCRIPTION | VALUE | V/W | TOL. | MFR'S DESIG | VXSTD P/N | VERS. | LOT | SIDE | LAY ADR |
|-----------------------|----------------|--------|-------|------|-----------------|-----------|-------|-----|------|---------|
| PCB with Components | | | | | | CB1232001 | | | | |
| Printed Circuit Board | | | | | | FR0054100 | | | 1- | |
| C 5001 | CHIP CAP. | 27pF | 50V | CH | GRM39CH270J50PT | K22174221 | | 1- | | |
| C 5002 | CHIP CAP. | 22pF | 50V | CH | GRM39CH220J50PT | K22174219 | | 1- | | |
| C 5003 | CHIP CAP. | 0.01uF | 50V | B | GRM39B103M50PT | K22174823 | | 1- | | |
| C 5004 | CHIP CAP. | 100pF | 50V | CH | GRM39CH101J50PT | K22174235 | | 1- | | |
| C 5005 | CHIP CAP. | 0.01uF | 50V | B | GRM39B103M50PT | K22174823 | | 1- | | |
| C 5006 | CHIP CAP. | 100pF | 50V | CH | GRM39CH101J50PT | K22174235 | | 1- | | |
| C 5007 | CHIP CAP. | 0.01uF | 50V | B | GRM39B103M50PT | K22174823 | | 1- | | |
| C 5008 | CHIP TA.CAP. | 10uF | 6.3V | | TESVSP0J106M-8R | K78080055 | | 1- | | |
| J 5001 | CONNECTOR | | | | 9117S-03D | P1091095 | | 1- | | |
| J 5002 | CONNECTOR | | | | 9117S-04D | P1090873 | | 1- | | |
| Q 5001 | TRANSISTOR | | | | 2SC4400-4-TL | G3344008D | | 1- | | |
| Q 5002 | TRANSISTOR | | | | 2SC4400-4-TL | G3344008D | | 1- | | |
| R 5001 | CHIP RES. | 22k | 1/16W | 5% | RMC1/16 223JATP | J24185223 | | 1- | | |
| R 5002 | CHIP RES. | 330 | 1/16W | 5% | RMC1/16 331JATP | J24185331 | | 1- | | |
| R 5003 | CHIP RES. | 330k | 1/16W | 5% | RMC1/16 334JATP | J24185334 | | 1- | | |
| R 5004 | CHIP RES. | 100 | 1/16W | 5% | RMC1/16 101JATP | J24185101 | | 1- | | |
| R 5005 | CHIP RES. | 10k | 1/16W | 5% | RMC1/16 103JATP | J24185103 | | 1- | | |
| R 5006 | CHIP RES. | 2.2k | 1/16W | 5% | RMC1/16 222JATP | J24185222 | | 1- | | |
| R 5007 | CHIP RES. | 4.7k | 1/16W | 5% | RMC1/16 472JATP | J24185472 | | 1- | | |
| TC5001 | TRIMMER CAP. | 20pF | | | ECR-JA020E11X | K91000228 | | 1- | | |
| X 5001 | XTAL TSS-6035B | | | | 22.625MHZ | H0103273 | | 1- | | |

PHONE-JACK Unit

Circuit Diagram

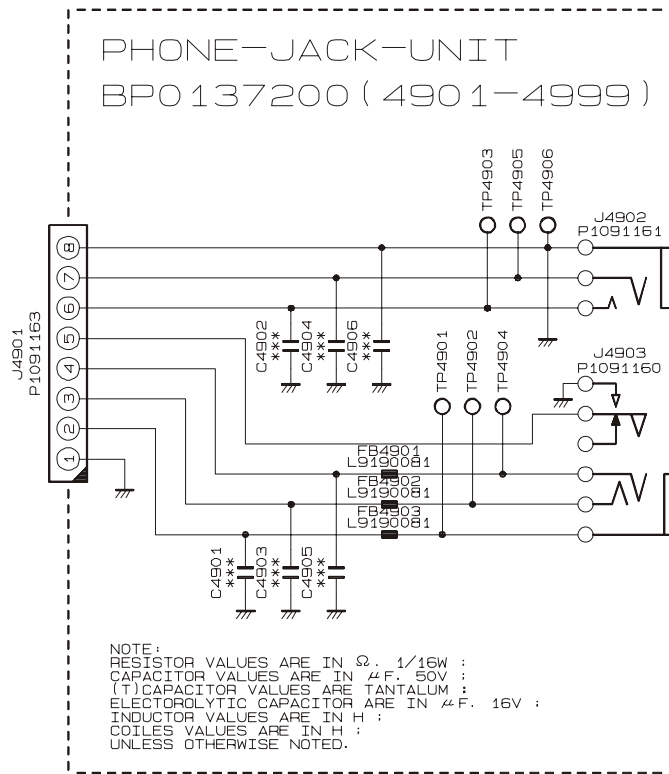

Parts Layout

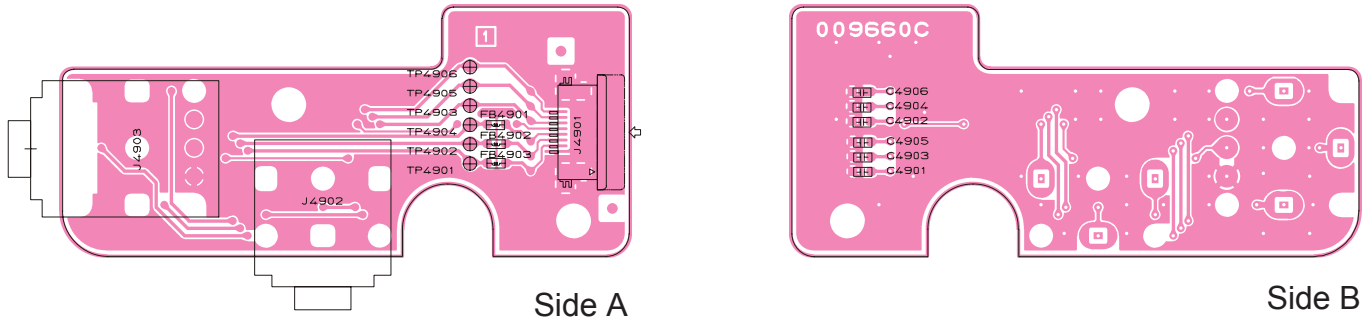

Parts List

| REF | DESCRIPTION | VALUE | V/W | TOL. | MFR'S DESIG | VXSTD P/N | VERS. | LOT | SIDE | LAY ADR |
|--------|-----------------------|-------|-----|------|----------------|-----------|-------|-----|------|---------|
| | PCB with Components | | | | | CB2331001 | | | | |
| | Printed Circuit Board | | | | AH007M000 | FR0096600 | | 1- | | |
| FB4901 | FERRITE BEADS | | | | BK1608HS121-T | L9190081 | | 1- | | |
| FB4902 | FERRITE BEADS | | | | BK1608HS121-T | L9190081 | | 1- | | |
| FB4903 | FERRITE BEADS | | | | BK1608HS121-T | L9190081 | | 1- | | |
| J 4901 | CONNECTOR | | | | 52746-0890 | P1091163 | | 1- | | |
| J 4902 | CONNECTOR | | | | HSJ7062-01-440 | P1091161 | | 1- | | |
| J 4903 | CONNECTOR | | | | HSJ7063-01-440 | P1091160 | | 1- | | |
| P 4901 | WIRE ASSY | | | | AH007M | T9207025 | | 1- | | |

VR Unit

Circuit Diagram

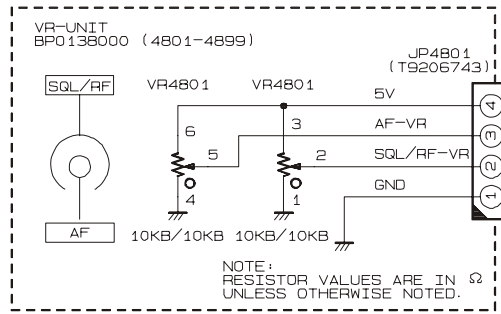

Parts Layout

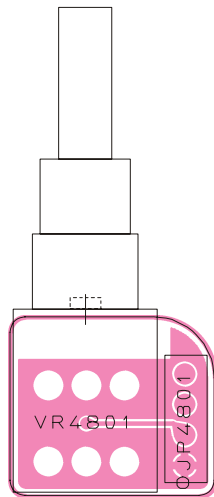

Side A

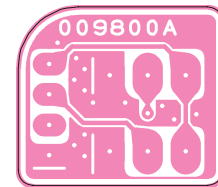

Side B

Parts List

| REF | DESCRIPTION | VALUE | VW | TOL. | MFR'S DESIG | VXSTD P/N | VERS. | LOT | SIDE | LAY ADR |
|--------|-----------------------|-------|----|------|---------------------|-----------|-------|-----|------|---------|
| | PCB with Components | | | | | CB2339001 | | | | |
| | Printed Circuit Board | | | | AH007M000 | FR0098000 | | | | |
| VR4801 | POT. | | | | RK0972210 10KB/10KB | J62800141 | | 1- | A | |

CONNECTOR Unit

Circuit Diagram

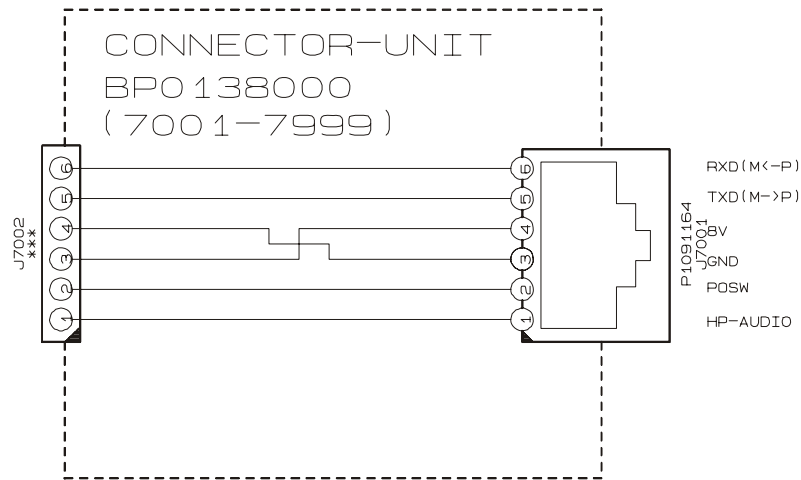

Parts Layout

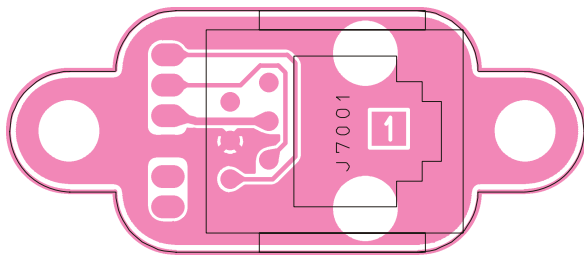

Side A

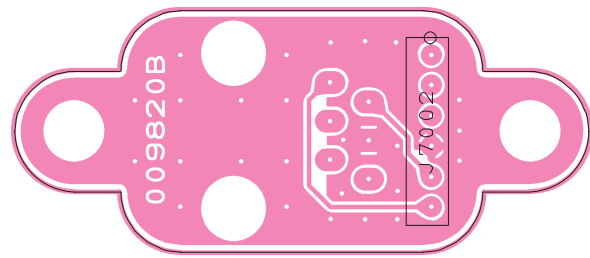

Side B

Parts List

| REF | DESCRIPTION | VALUE | V/W | TOL. | MFR'S DESIG | VXSTD P/N | VERS. | LOT | SIDE | LAY ADR |
|--------|-----------------------|-------|-----|------|----------------|-----------|-------|-----|------|---------|
| | PCB with Components | | | | | CB2338001 | | | | |
| | Printed Circuit Board | | | | AH007M000 | FR009820B | | 1- | | |
| J 7001 | CONNECTOR | | | | HJC0278-010022 | P1091164 | | 1- | | |
| J 7002 | WIRE ASSY | | | | AH007M | T9207023 | | 1- | | |

DSP-2 Unit (FT-857 Option)

Parts List

| REF | DESCRIPTION | VALUE | V/W | TOL. | MFR'S DESIG | VXSTD P/N | VERS. | LOT | SIDE | LAY ADR |
|--------|-----------------------|----------|-------|------|-----------------------|-----------|-------|-----|------|---------|
| | Printed Circuit Board | | | | AAC62X000 | FR0079600 | | 1- | | |
| C 6001 | CHIP CAP. | 1uF | 10V | B | GRM40B105K10PT | K22100802 | | 1- | B | |
| C 6002 | CHIP CAP. | 1uF | 10V | B | GRM40B105K10PT | K22100802 | | 1- | B | |
| C 6004 | CHIP CAP. | 0.01uF | 16V | B | GRM36B103K16PT | K22128804 | | 1- | A | |
| C 6005 | CHIP CAP. | 0.0018uF | 50V | B | GRM39B182M50PT | K22174812 | | 1- | A | |
| C 6006 | CHIP CAP. | 1uF | 10V | B | GRM40B105K10PT | K22100802 | | 1- | B | |
| C 6007 | CHIP CAP. | 1uF | 10V | B | GRM40B105K10PT | K22100802 | | 1- | B | |
| C 6008 | CHIP CAP. | 0.0015uF | 50V | B | GRM36B152K50PT | K22178811 | | 1- | B | |
| C 6009 | CHIP CAP. | 0.0015uF | 50V | B | GRM36B152K50PT | K22178811 | | 1- | A | |
| C 6010 | CHIP CAP. | 0.012uF | 50V | B | GRM39B123K50PT | K22174825 | | 1- | B | |
| C 6011 | CHIP TA.CAP. | 10uF | 10V | | TEMSVA1A106M-8R | K78100028 | | 1- | B | |
| C 6012 | CHIP TA.CAP. | 10uF | 10V | | TEMSVA1A106M-8R | K78100028 | | 1- | A | |
| C 6013 | CHIP CAP. | 0.1uF | 16V | B | GRM39B104K16PT | K22124805 | | 1- | B | |
| C 6014 | CHIP TA.CAP. | 10uF | 10V | | TEMSVA1A106M-8R | K78100028 | | 1- | A | |
| C 6015 | CHIP CAP. | 0.01uF | 16V | B | GRM36B103K16PT | K22128804 | | 1- | B | |
| C 6016 | CHIP CAP. | 0.0047uF | 25V | B | GRM36B472K25PT | K22148830 | | 1- | B | |
| C 6017 | CHIP CAP. | 0.1uF | 16V | B | GRM39B104K16PT | K22124805 | | 1- | A | |
| C 6018 | CHIP CAP. | 0.1uF | 16V | B | GRM39B104K16PT | K22124805 | | 1- | A | |
| C 6019 | CHIP CAP. | 0.0056uF | 25V | B | GRM36B562K50PT | K22148802 | | 1- | B | |
| C 6020 | CHIP CAP. | 1uF | 10V | B | GRM40B105K10PT | K22100802 | | 1- | B | |
| C 6021 | CHIP TA.CAP. | 10uF | 10V | | TEMSVA1A106M-8R | K78100028 | | 1- | B | |
| C 6022 | CHIP CAP. | 0.01uF | 16V | B | GRM36B103K16PT | K22128804 | | 1- | B | |
| C 6023 | CHIP TA.CAP. | 10uF | 10V | | TEMSVA1A106M-8R | K78100028 | | 1- | A | |
| C 6024 | CHIP CAP. | 0.01uF | 16V | B | GRM36B103K16PT | K22128804 | | 1- | B | |
| C 6025 | CHIP CAP. | 0.01uF | 16V | B | GRM36B103K16PT | K22128804 | | 1- | B | |
| C 6027 | CHIP CAP. | 47pF | 50V | CH | GRM36CH470J50PT | K22178228 | | 1- | A | |
| C 6028 | CHIP CAP. | 0.1uF | 16V | B | GRM39B104K16PT | K22124805 | | 1- | B | |
| C 6029 | CHIP CAP. | 0.01uF | 16V | B | GRM36B103K16PT | K22128804 | | 1- | B | |
| C 6030 | CHIP CAP. | 0.01uF | 16V | B | GRM36B103K16PT | K22128804 | | 1- | B | |
| C 6031 | CHIP CAP. | 10pF | 50V | CH | GRM36CH100D50PT | K22178212 | | 1- | A | |
| C 6032 | CHIP CAP. | 0.01uF | 16V | B | GRM36B103K16PT | K22128804 | | 1- | B | |
| C 6033 | CHIP CAP. | 33pF | 50V | CH | GRM36CH330J50PT | K22178224 | | 1- | A | |
| C 6034 | CHIP CAP. | 0.1uF | 16V | B | GRM39B104K16PT | K22124805 | | 1- | A | |
| C 6035 | CHIP CAP. | 0.01uF | 16V | B | GRM36B103K16PT | K22128804 | | 1- | A | |
| C 6036 | CHIP CAP. | 4pF | 50V | CH | GRM36CH040C50PT | K22178206 | | 1- | B | |
| J 6001 | CONNECTOR | | | | IL-WX-16PB-HF-B-E1000 | P0091321 | | 1- | A | |
| L 6001 | CHIP COIL | 10uH | | | C2520F-100K | L1690596 | | 1- | A | |
| L 6002 | CHIP COIL | 10uH | | | C2520F-100K | L1690596 | | 1- | A | |
| L 6003 | CHIP COIL | 10uH | | | C2520F-100K | L1690596 | | 1- | A | |
| Q 6001 | IC | | | | NJM2902V-TE1 | G1091679 | | 1- | B | |
| Q 6002 | IC | | | | NJM2902V-TE1 | G1091679 | | 1- | B | |
| Q 6003 | IC | | | | AK7712VT | G1092699 | | 1- | B | |
| Q 6004 | TRANSISTOR | | | | DTC114EU T106 | G3070084 | | 1- | A | |
| R 6001 | CHIP RES. | 10k | 1/16W | 5% | RMC1/16S 103JTH | J24189037 | | 1- | B | |
| R 6002 | CHIP RES. | 10k | 1/16W | 5% | RMC1/16S 103JTH | J24189037 | | 1- | B | |
| R 6003 | CHIP RES. | 10k | 1/16W | 5% | RMC1/16S 103JTH | J24189037 | | 1- | B | |
| R 6004 | CHIP RES. | 10k | 1/16W | 5% | RMC1/16S 103JTH | J24189037 | | 1- | B | |
| R 6005 | CHIP RES. | 3.3k | 1/16W | 5% | RMC1/16S 332JTH | J24189031 | | 1- | A | |
| R 6006 | CHIP RES. | 3.3k | 1/16W | 5% | RMC1/16S 332JTH | J24189031 | | 1- | A | |
| R 6007 | CHIP RES. | 3.3k | 1/16W | 5% | RMC1/16S 332JTH | J24189031 | | 1- | A | |
| R 6008 | CHIP RES. | 3.3k | 1/16W | 5% | RMC1/16S 332JTH | J24189031 | | 1- | A | |
| R 6009 | CHIP RES. | 47k | 1/16W | 5% | RMC1/16S 473JTH | J24189045 | | 1- | B | |
| R 6010 | CHIP RES. | 33k | 1/16W | 5% | RMC1/16S 333JTH | J24189043 | | 1- | B | |
| R 6011 | CHIP RES. | 10k | 1/16W | 5% | RMC1/16S 103JTH | J24189037 | | 1- | B | |
| R 6012 | CHIP RES. | 10k | 1/16W | 5% | RMC1/16S 103JTH | J24189037 | | 1- | B | |
| R 6014 | CHIP RES. | 10k | 1/16W | 5% | RMC1/16S 103JTH | J24189037 | | 1- | B | |
| R 6015 | CHIP RES. | 68k | 1/16W | 5% | RMC1/16S 683JTH | J24189047 | | 1- | B | |
| R 6016 | CHIP RES. | 10k | 1/16W | 5% | RMC1/16S 103JTH | J24189037 | | 1- | B | |
| R 6017 | CHIP RES. | 68k | 1/16W | 5% | RMC1/16S 683JTH | J24189047 | | 1- | B | |
| R 6018 | CHIP RES. | 330 | 1/16W | 5% | RMC1/16S 331JTH | J24189019 | | 1- | B | |
| R 6019 | CHIP RES. | 100 | 1/10W | 5% | RMC1/10T 101J | J24205101 | | 1- | A | |
| R 6020 | CHIP RES. | 330 | 1/16W | 5% | RMC1/16S 331JTH | J24189019 | | 1- | B | |
| R 6021 | CHIP RES. | 3.3k | 1/16W | 5% | RMC1/16S 332JTH | J24189031 | | 1- | A | |
| R 6022 | CHIP RES. | 3.3k | 1/16W | 5% | RMC1/16S 332JTH | J24189031 | | 1- | A | |
| R 6023 | CHIP RES. | 330 | 1/16W | 5% | RMC1/16S 331JTH | J24189019 | | 1- | B | |
| R 6024 | CHIP RES. | 330 | 1/16W | 5% | RMC1/16S 331JTH | J24189019 | | 1- | B | |
| R 6025 | CHIP RES. | 6.8k | 1/16W | 5% | RMC1/16S 682JTH | J24189035 | | 1- | B | |
| R 6026 | CHIP RES. | 6.8k | 1/16W | 5% | RMC1/16S 682JTH | J24189035 | | 1- | B | |
| R 6028 | CHIP RES. | 6.8k | 1/16W | 5% | RMC1/16S 682JTH | J24189035 | | 1- | B | |
| R 6029 | CHIP RES. | 6.8k | 1/16W | 5% | RMC1/16S 682JTH | J24189035 | | 1- | B | |
| R 6030 | CHIP RES. | 2.2M | 1/16W | 5% | RMC1/16S 225JTH | J24189065 | | 1- | B | |
| R 6031 | CHIP RES. | 470 | 1/16W | 5% | RMC1/16S 471JTH | J24189021 | | 1- | A | |
| R 6032 | CHIP RES. | 470 | 1/16W | 5% | RMC1/16S 471JTH | J24189021 | | 1- | A | |

DSP-2 Unit (FT-857 Option)

Parts List

| REF | DESCRIPTION | VALUE | V/W | TOL. | MFR'S DESIG | VXSTD P/N | VERS. | LOT | SIDE | LAY ADR |
|--------|----------------|---------|-------|------|-----------------|-----------|-------|-----|------|---------|
| R 6033 | CHIP RES. | 470 | 1/16W | 5% | RMC1/16S 471JTH | J24189021 | | 1- | A | |
| R 6034 | CHIP RES. | 470 | 1/16W | 5% | RMC1/16S 471JTH | J24189021 | | 1- | A | |
| R 6035 | CHIP RES. | 470 | 1/16W | 5% | RMC1/16S 471JTH | J24189021 | | 1- | A | |
| R 6036 | CHIP RES. | 470 | 1/16W | 5% | RMC1/16S 471JTH | J24189021 | | 1- | A | |
| R 6037 | CHIP RES. | 470 | 1/16W | 5% | RMC1/16S 471JTH | J24189021 | | 1- | A | |
| R 6038 | CHIP RES. | 100 | 1/16W | 5% | RMC1/16S 101JTH | J24189013 | | 1- | B | |
| X 6001 | XTAL TSS-7050A | 8.23MHz | | | 8.230MHZ | H0103261 | | 1- | A | |

TCXO-9 Unit (Option)

Circuit Diagram

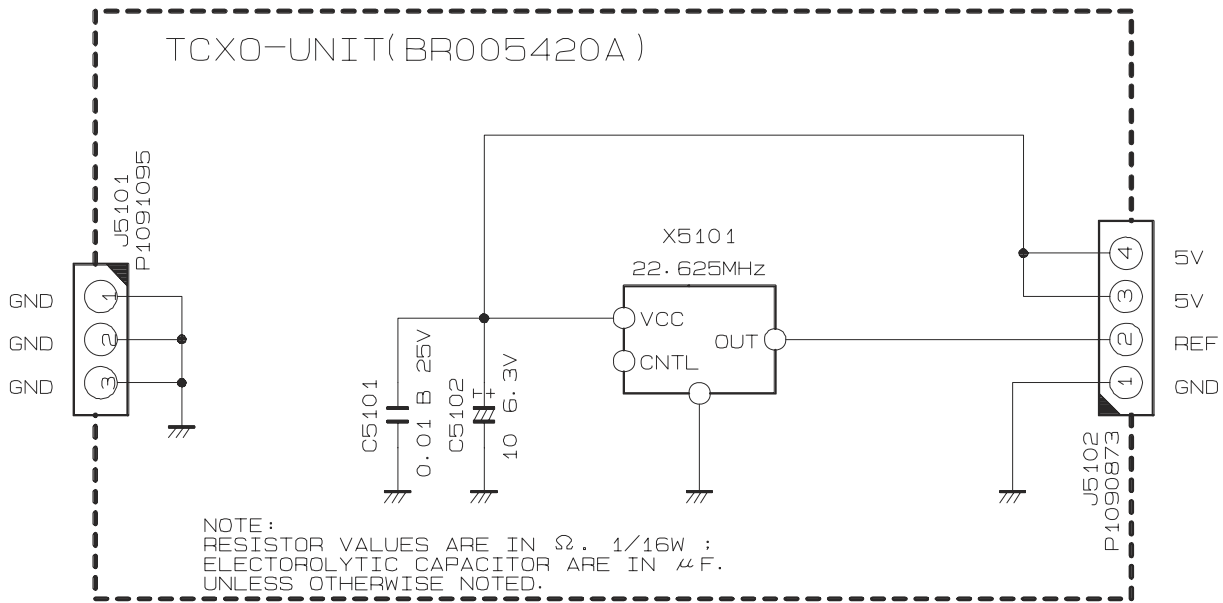

Parts Layout

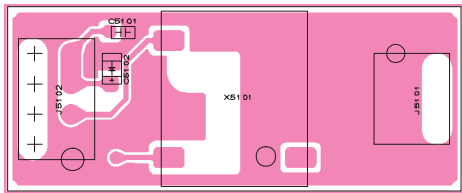

Side A

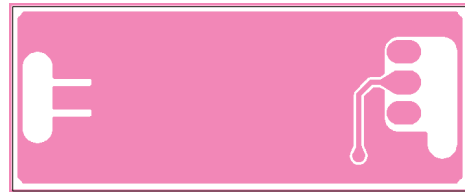

Side B

Parts List

| REF | DESCRIPTION | VALUE | V/W | TOL. | MFR'S DESIG | VXSTD P/N | VERS. | LOT | SIDE | LAY ADR |
|--------|-----------------------|-----------|------|------|---------------------|-----------|-------|-----|------|---------|
| | Printed Circuit Board | | | | | FR005860C | | 1- | | |
| C 5101 | CHIP CAP. | 0.01uF | 25V | B | GRM39B103K25PT | K22144803 | | 1- | | |
| C 5102 | CHIP TA.CAP. | 10uF | 6.3V | | TESVSP0J106M-8R | K78080055 | | 1- | | |
| J 5101 | CONNECTOR | | | | 9117S-03D | P1091095 | | 1- | | |
| J 5102 | CONNECTOR | | | | 9117S-04D | P1090873 | | 1- | | |
| X 5101 | XTAL OSC | 22.625MHZ | | | NT0-801BS 22.625MHZ | H9500560 | | 1- | | |



Copyright 2007
VERTEX STANDARD CO., LTD.
All rights reserved

No portion of this manual
may be reproduced without
the permission of
VERTEX STANDARD CO., LTD.